



Sonosite ST

User Guide

Manufacturer	EC Authorized Representative	UK Responsible Person	Australia Sponsor
FUJIFILM SonoSite, Inc. 21919 30th Drive SE Bothell, WA 98021 USA T: 1-888-482-9449 or 1-425-951-1200 F: 1-425-951-1201	FUJIFILM SonoSite B.V. Joop Geesinkweg 140 1114 AB Amsterdam, The Netherlands	FUJIFILM Healthcare UK Limited Fujifilm House Whitbread Way Bedford MK42 0ZE United Kingdom	FUJIFILM SonoSite Australasia Pty Ltd 114 Old Pittwater Road BROOKVALE, NSW, 2100 Australia



CAUTION

United States federal law restricts this device to sale by or on the order of a physician.

SonoMB, SONOSITE, Steep Needle Profiling, and the SONOSITE logo are trademarks and registered trademarks of FUJIFILM SonoSite, Inc., in various jurisdictions. FUJIFILM is a registered trademark of FUJIFILM Corporation in various jurisdictions. Value from Innovation is a trademark of FUJIFILM Holdings America Corporation. DICOM is a registered trademark of the National Electrical Manufacturers Association. All other trademarks are the property of their respective owners.

Contains FCC certified transmitter module W23-WMU-62XX

Contains IC: 24633-WMU62XX

Patent: www.sonosite.com/patents



Part number: P31244-03

Published Jul 19, 2024

Copyright © 2024 FUJIFILM SonoSite, Inc. All rights reserved.

Table of Contents

Introduction	1
About the user guide	1
Getting help	2
Intended Use	3
Indications for use	3
Biometric Measurements	9
Contraindications	10
Getting Started	11
About the Sonosite ST system	11
Basic operating steps	11
Hardware features	12
Preparing the system	13
Powering the system	15
Inserting and removing USB devices	19
General interaction	20
Preparing transducers	25
On-board educational videos	28
Configuring the System	30
Navigating system settings	30
Returning to factory defaults	30
Using the system as an administrator	31
Logging in and out	41
Audio settings	42
Connectivity and DICOM settings	43
Customization settings	50
Date and time settings	54
Display information settings	54
Network status	55
Power and battery settings	55
General settings	56
System information	57
USB settings	58
Logs	59
Entering Patient Information	61
Ending the previous study	61
Creating a new patient	61
Using the worklist	64
Saving patient information	66
Editing or adding patient information during an exam	66
Reviewing patient information	66
Scanning	68
Understanding imaging modes	68
Imaging controls	68
Scanning in 2D	69
Scanning in M Mode	71

Scanning in Doppler	72
Scanning in Color	74
Scanning in dual mode	76
Scanning in simultaneous mode	76
Adjusting the depth	77
Adjusting the gain	77
Zooming	78
Viewing frames in the cine buffer	78
Voice commands	79
Using the centerline	80
Needle profiling	82
Needle guide control	84
Managing Images and Clips	86
Saving an image or a clip	86
Labeling images	87
Printing images	89
Archiving and exporting images and clips	90
Image gallery	91
Measurements and Calculations	92
Performing measurements and calculations	92
Calculations and analysis packages	101
Managing Patient Data	121
Managing studies	121
Managing reports and worksheets	125
Reviewing images, clips, and measurements	127
Measurement References	130
Measurement accuracy	130
Measurement publications and terminology	131
Troubleshooting and Maintenance	151
Troubleshooting	151
Software licensing	152
Maintenance	154
Cleaning and Disinfecting	156
Before getting started	156
Determining the required cleaning and disinfecting level	157
Option A: Clean and disinfect system, stand, and transducer to a high-level (semi-critical uses)	158
Option B: Clean and disinfect the system, stand, and transducer to a low-level (non-critical uses)	162
Storing the transducer	165
Transporting the transducer	166
Cleaning and disinfecting accessories	167
Safety	168
Ergonomic safety	168
Electrical safety	170
Equipment safety	174

Battery safety	175
Clinical safety	176
Hazardous materials	177
Electromagnetic compatibility	177
Labeling symbols	186
Specifications	190
Standards	193
Acoustic Output	195
ALARA principle	195
Acoustic artifacts	196
Output display	196
Transducer surface temperature rise	198
Acoustic output measurement	199
Tissue models and equipment survey	200
Acoustic output tables	201
Acoustic measurement precision and uncertainty	255
IT Network	256
Functions	256
Data backup	256
Network specifications for connecting the device	256
Application approved list	261
IT network failure recovery measures	262
Wireless connectivity	263
Implementing, detecting, and maintaining security	263
Glossary	264
Index	275

Introduction

About the user guide

The *Sonosite ST User Guide* provides information on preparing and using the Sonosite ST ultrasound system and on cleaning and disinfecting the system and transducers. It also provides system specifications, and safety and acoustic output information.



NOTE



We highly recommend you read the entire user guide before using the system.

This user guide is meant for users familiar with ultrasound. It does not provide training in sonography, ultrasound, or clinical practices. Before using the Sonosite ST ultrasound system, you must complete such training.

For information on using accessories and peripherals, refer to the applicable accessory user guide and manufacturer's instructions.

Document conventions

The document follows these conventions:

- A  **WARNING** describes precautions necessary to prevent injury or loss of life.
- A  **CAUTION** describes precautions necessary to protect the products.
- A  **NOTE** provides supplemental information.
- Numbered and lettered steps must be performed in a specific order.
- Bulleted lists present information in list format but do not imply a sequence.

Symbols and terms used on the system and transducers are explained in [Labeling symbols \[186\]](#) and the [Glossary \[264\]](#).

Updates

The software and hardware features described in this version of the user guide could include features that are unavailable on your version of the system. The user guide version corresponds to the software version on your system (see [System information \[57\]](#)). Please contact FUJIFILM Sonosite Technical Support if you need an older version of the user guide.

Table 1. Updates in version 4.0

Features	Description
Battery and power	Added Performance and Efficiency modes [55] to the power and battery settings.
Custom labels	Added the ability to create custom text labels [52] .

Features	Description
Connectivity and workflow improvements	<ul style="list-style-type: none"> Added the ability to customize modality worklist (MWL) mapping [48]. Added the ability to select multiple archives to send data to when ending an exam [61]. Added the ability to add patient information from the worklist during an exam [66]. Added the ability to add multiple providers to a patient study [62].
New transducers and exam types	<ul style="list-style-type: none"> Added the L13-6 [26] transducer and associated exam types. Added the Vascular Access [26] exam type to the L19-5 transducer. Added the Procedural Abdomen [26] exam type to the C5-1 transducer.
New calculations	Added the CVR (catheter to vessel ratio) [114] calculations package.
New imaging options	<ul style="list-style-type: none"> Optimized imaging for various exam types and transducers including an updated Optimize [69] control. Added the RFID Shield [69] control to reduce RFID (radio-frequency identification) interference to the ultrasound signal. Added trapezoidal imaging. See 2D imaging controls [69] for a description.
Measure and label in review	Added the ability to measure and label images after saving them. See Labeling and measuring during review [128] for a description of the feature.
System Portal	Added the ability to remotely update and monitor [39] the system.
Voice Assist	Added the ability to control the system using voice commands [79] . See Voice activated controls [24] for a description of the feature.

Getting help

In addition to the system user guide, the following are available:

- On-board educational videos
- On-board help and user guide: tap an information button 
- FUJIFILM Sonosite Technical Support:

United States and Canada	+1 877-657-8118
Europe and Middle East	Main: +31 20 751 2020 English support: +44 14 6234 1151 French support: +33 1 8288 0702 German support: +49 69 8088 4030 Italian support: +39 02 9475 3655 Spanish support: +34 91 123 8451
Asia and Pacific	+61 2 9938 8700
Other regions	+1 425-951-1330 or call your local representative
Fax	+1 425-951-6700
Email	General: ffss-service@fujifilm.com United Kingdom: uk-service@fujifilm.com Europe, Middle East, and Africa: eraf-service@fujifilm.com Asia and Pacific: ffss-apacme-service@fujifilm.com
Web	www.sonosite.com

Intended Use

The intended use is: Medical Diagnostic Ultrasound. The Sonosite ST ultrasound system is intended for diagnostic ultrasound imaging or fluid flow analysis of the human body.

Indications for use

Diagnostic ultrasound

The Sonosite ST ultrasound system is a general purpose ultrasound system intended for use by qualified physicians and healthcare professionals for evaluation by ultrasound imaging or fluid flow analysis of the human body. Specific clinical applications and exam types include:

- Abdominal
- Adult Cephalic
- Cardiac Adult
- Cardiac Pediatric
- Fetal - OB/GYN
- Musculo-skeletal (Conventional)
- Musculo-skeletal (Superficial)
- Ophthalmic
- Pediatric
- Peripheral vessel
- Small Organ (breast, thyroid, testicles, prostate)
- Transvaginal
- Needle Guidance

Modes of operation include: B Mode (B), M-Mode (M) (including simultaneous M-mode), PW Doppler (PWD) (including simultaneous PWD for certain exam types), Tissue Doppler Imaging (TDI), Continuous Wave Doppler (CWD), Color Power Doppler, Velocity Color Doppler, Color Variance, Tissue Harmonic Imaging (THI), Multi-beam imaging, Steep Needle Profiling, Trapezoid, and combined modes, including duplex and triplex imaging: B+M, B+PWD, B+CWD, B+C, (B+C)+PWD, (B+C)+CWD.

This device is indicated for Prescription Use Only.

The Sonosite ST system is intended to be used in medical practices, clinical environments, including healthcare facilities, hospitals, clinics, and clinical point-of-care for diagnosis of patients.

The system is used with a transducer attached and is powered either by battery or by AC electrical power. The clinician is positioned next to the patient and places the transducer onto the patient's body where needed to obtain the desired ultrasound image.

Clinical applications

The following indications for use tables display the clinical applications and imaging modes for the system and transducers. The predefined exam types available on each transducer are displayed in [Selecting a transducer and exam type \[26\]](#).

The indications for use table key applies to all the following indications for use tables.

Table 2. Indications for use table key.

a	2D = B Mode; M = M Mode including simultaneous; PWD = Pulse Wave Doppler; CWD = Continuous Wave Doppler; C = Color Doppler (Color Velocity Doppler or CVD, Color Power Doppler or CPD, Variance or Var)
b	Steep Needle Profiling (SNP) = Needle enhancement in B Mode
c	Tissue Harmonic Imaging (THI)
d	Tissue Doppler Imaging (TDI)
e	Multi-beam imaging (SonoMB) in B Mode
f	Color Doppler includes Power/Velocity
g	Color Doppler includes Velocity/Variance
h	Includes imaging to assist in the placement of needles and catheters in vascular or other anatomical structures
i	B+PWD and (B+C)+PWD includes simultaneous PWD



NOTE

PWD and CWD are only available in some countries with the licensed Doppler option.

Table 3. Sonosite ST diagnostic ultrasound indications for use

Intended use:	Diagnostic ultrasound imaging or fluid flow analysis of the human body as follows:						
Clinical application	Mode of operation ^a						Other (spec.)
	2D	M	C	PWD	CWD	Combined (spec.)	
Abdominal	✓	✓	✓	✓	—	B+M; B+PWD; B+C; (B+C)+PWD	c, e, f
Adult cephalic	✓	✓	✓	✓	—	B+M; B+PWD; B+C; (B+C)+PWD	f
Cardiac adult	✓	✓	✓	✓	✓	B+M; B+PWD; B+CWD; B+C; (B+C)+PWD; (B+C)+CWD	c, d, f, g
Cardiac pediatric	✓	✓	✓	✓	✓	B+M; B+PWD; B+CWD; B+C; (B+C)+PWD; (B+C)+CWD	c, d, f, g
Fetal - OB/GYN	✓	✓	✓	✓	—	B+M; B+PWD; B+C; (B+C)+PWD	c, e, f, h
Musculoskeletal (conventional)	✓	✓	✓	✓	—	B+M; B+PWD; B+C; (B+C)+PWD	b, c, e, f, h
Musculoskeletal (superficial)	✓	✓	✓	✓	—	B+M; B+PWD; B+C; (B+C)+PWD	b, c, e, f, h
Ophthalmic	✓	✓	✓	✓	—	B+M; B+PWD; B+C; (B+C)+PWD	c, e, f
Pediatric	✓	✓	✓	✓	—	B+M; B+PWD; B+C; (B+C)+PWD	b, c, e, f, h
Peripheral vessel	✓	✓	✓	✓	—	B+M; B+PWD; B+C; (B+C)+PWD	b, c, e, f, h, i
Small organ (breast, thyroid, testicles, prostate)	✓	✓	✓	✓	—	B+M; B+PWD; B+C; (B+C)+PWD	b, c, e, f, h
Transrectal	✓	✓	✓	✓	—	B+M; B+PWD; B+C; (B+C)+PWD	c, e, f, h
Transvaginal	✓	✓	✓	✓	—	B+M; B+PWD; B+C; (B+C)+PWD	c, e, f, h

Table 4. C5-1 transducer diagnostic ultrasound indications for use

Intended use:	Diagnostic ultrasound imaging or fluid flow analysis of the human body as follows:						
Clinical application	Mode of operation ^a						Other (spec.)
	2D	M	C	PWD	CWD	Combined (spec.)	
Abdominal	✓	✓	✓	✓	—	B+M; B+PWD; B+C; (B+C)+PWD	c, e, f

Intended use:	Diagnostic ultrasound imaging or fluid flow analysis of the human body as follows:						
Clinical application	Mode of operation ^a						
	2D	M	C	PWD	CWD	Combined (spec.)	Other (spec.)
Cardiac adult	✓	✓	✓	✓	—	B+M; B+PWD; B+C; (B+C)+PWD	f
Cardiac pediatric	✓	✓	✓	✓	—	B+M; B+PWD; B+C; (B+C)+PWD	f
Fetal - OB/GYN	✓	✓	✓	✓	—	B+M; B+PWD; B+C; (B+C)+PWD	c, e, f
Musculoskeletal (conventional)	✓	✓	✓	✓	—	B+M; B+PWD; B+C; (B+C)+PWD	b, c, e, f
Pediatric	✓	✓	✓	✓	—	B+M; B+PWD; B+C; (B+C)+PWD	b, c, e, f
Peripheral vessel	✓	✓	✓	✓	—	B+M; B+PWD; B+C; (B+C)+PWD	b, c, e, f



NOTE

The C5-1 transducer is capable of imaging superficial MSK. The frequency is limited to 3.5 MHz.

Table 5. C10-3 transducer diagnostic ultrasound indications for use

Intended use:	Diagnostic ultrasound imaging or fluid flow analysis of the human body as follows:						
Clinical application	Mode of operation ^a						
	2D	M	C	PWD	CWD	Combined (spec.)	Other (spec.)
Abdominal	✓	✓	✓	✓	—	B+M; B+PWD; B+C; (B+C)+PWD	c, e, f
Cardiac adult	✓	✓	✓	✓	—	B+M; B+PWD; B+C; (B+C)+PWD	f
Cardiac pediatric	✓	✓	✓	✓	—	B+M; B+PWD; B+C; (B+C)+PWD	f
Fetal - OB/GYN	✓	✓	✓	✓	—	B+M; B+PWD; B+C; (B+C)+PWD	c, e, f
Musculoskeletal (conventional)	✓	✓	✓	✓	—	B+M; B+PWD; B+C; (B+C)+PWD	c, e, f
Pediatric	✓	✓	✓	✓	—	B+M; B+PWD; B+C; (B+C)+PWD	c, e, f

Table 6. IC10-3 transducer diagnostic ultrasound indications for use

Intended use:	Diagnostic ultrasound imaging or fluid flow analysis of the human body as follows:						
Clinical application	Mode of operation ^a						
	2D	M	C	PWD	CWD	Combined (spec.)	Other (spec.)
Fetal - OB/GYN	✓	✓	✓	✓	—	B+M; B+PWD; B+C; (B+C)+PWD	c, e, f, h
Transrectal	✓	✓	✓	✓	—	B+M; B+PWD; B+C; (B+C)+PWD	c, e, f, h
Transvaginal	✓	✓	✓	✓	—	B+M; B+PWD; B+C; (B+C)+PWD	c, e, f, h

Table 7. L12-3 transducer diagnostic ultrasound indications for use

Intended use:	Diagnostic ultrasound imaging or fluid flow analysis of the human body as follows:						
Clinical application	Mode of operation ^a						
	2D	M	C	PWD	CWD	Combined (spec.)	Other (spec.)
Cardiac adult	✓	✓	✓	✓	—	B+M; B+PWD; B+C; (B+C)+PWD	f
Cardiac pediatric	✓	✓	✓	✓	—	B+M; B+PWD; B+C; (B+C)+PWD	f
Musculoskeletal (conventional)	✓	✓	✓	✓	—	B+M; B+PWD; B+C; (B+C)+PWD	b, c, e, f
Musculoskeletal (superficial)	✓	✓	✓	✓	—	B+M; B+PWD; B+C; (B+C)+PWD	b, c, e, f
Ophthalmic	✓	✓	✓	✓	—	B+M; B+PWD; B+C; (B+C)+PWD	e, f

Intended use:	Diagnostic ultrasound imaging or fluid flow analysis of the human body as follows:						
Clinical application	Mode of operation ^a						
	2D	M	C	PWD	CWD	Combined (spec.)	Other (spec.)
Pediatric	✓	✓	✓	✓	—	B+M; B+PWD; B+C; (B+C)+PWD	b, c, e, f
Peripheral vessel	✓	✓	✓	✓	—	B+M; B+PWD; B+C; (B+C)+PWD	b, c, e, f, i
Small organ (breast, thyroid, testicles, prostate)	✓	✓	✓	✓	—	B+M; B+PWD; B+C; (B+C)+PWD	b, c, e, f

Table 8. L13-6 transducer diagnostic ultrasound indications for use

Intended use:	Diagnostic ultrasound imaging or fluid flow analysis of the human body as follows:						
Clinical application	Mode of operation ^a						
	2D	M	C	PWD	CWD	Combined (spec.)	Other (spec.)
Musculoskeletal (conventional)	✓	✓	✓	✓	—	B+M; B+PWD; B+C; (B+C)+PWD	b, c, e, f
Musculoskeletal (superficial)	✓	✓	✓	✓	—	B+M; B+PWD; B+C; (B+C)+PWD	b, c, e, f
Pediatric	✓	✓	✓	✓	—	B+M; B+PWD; B+C; (B+C)+PWD	b, c, e, f
Peripheral vessel	✓	✓	✓	✓	—	B+M; B+PWD; B+C; (B+C)+PWD	b, c, e, f, i
Small organ (breast, thyroid, testicles, prostate)	✓	✓	✓	✓	—	B+M; B+PWD; B+C; (B+C)+PWD	b, c, e, f

Table 9. L15-4 transducer diagnostic ultrasound indications for use

Intended use:	Diagnostic ultrasound imaging or fluid flow analysis of the human body as follows:						
Clinical application	Mode of operation ^a						
	2D	M	C	PWD	CWD	Combined (spec.)	Other (spec.)
Musculoskeletal (conventional)	✓	✓	✓	✓	—	B+M; B+PWD; B+C; (B+C)+PWD	b, c, e, f
Musculoskeletal (superficial)	✓	✓	✓	✓	—	B+M; B+PWD; B+C; (B+C)+PWD	b, c, e, f
Pediatric	✓	✓	✓	✓	—	B+M; B+PWD; B+C; (B+C)+PWD	b, c, e, f
Peripheral vessel	✓	✓	✓	✓	—	B+M; B+PWD; B+C; (B+C)+PWD	b, c, e, f, i
Small organ (breast, thyroid, testicles, prostate)	✓	✓	✓	✓	—	B+M; B+PWD; B+C; (B+C)+PWD	b, c, e, f

Table 10. L19-5 transducer diagnostic ultrasound indications for use

Intended use:	Diagnostic ultrasound imaging or fluid flow analysis of the human body as follows:						
Clinical application	Mode of operation ^a						
	2D	M	C	PWD	CWD	Combined (spec.)	Other (spec.)
Cardiac adult	✓	✓	✓	✓	—	B+M; B+PWD; B+C; (B+C)+PWD	f
Cardiac pediatric	✓	✓	✓	✓	—	B+M; B+PWD; B+C; (B+C)+PWD	f
Musculoskeletal (conventional)	✓	✓	✓	✓	—	B+M; B+PWD; B+C; (B+C)+PWD	b, c, e, f, h
Musculoskeletal (superficial)	✓	✓	✓	✓	—	B+M; B+PWD; B+C; (B+C)+PWD	b, c, e, f, h
Ophthalmic	✓	✓	✓	✓	—	B+M; B+PWD; B+C; (B+C)+PWD	e, f
Pediatric	✓	✓	✓	✓	—	B+M; B+PWD; B+C; (B+C)+PWD	b, c, e, f, h
Peripheral vessel	✓	✓	✓	✓	—	B+M; B+PWD; B+C; (B+C)+PWD	b, c, e, f, h, i
Small organ (breast, thyroid, testicles, prostate)	✓	✓	✓	✓	—	B+M; B+PWD; B+C; (B+C)+PWD	b, c, e, f, h

Table 11. P5-1 transducer diagnostic ultrasound indications for use

Intended use:	Diagnostic ultrasound imaging or fluid flow analysis of the human body as follows:						
Clinical application	Mode of operation ^a						
	2D	M	C	PWD	CWD	Combined (spec.)	Other (spec.)
Abdominal	✓	✓	✓	✓	—	B+M; B+PWD; B+C; (B+C)+PWD	c, e, f
Adult cephalic	✓	✓	✓	✓	—	B+M; B+PWD; B+C; (B+C)+PWD	f
Cardiac adult	✓	✓	✓	✓	✓	B+M; B+PWD; B+CWD; B+C; (B+C)+PWD; (B+C)+CWD	c, d, f, g
Cardiac pediatric	✓	✓	✓	✓	✓	B+M; B+PWD; B+CWD; B+C; (B+C)+PWD; (B+C)+CWD	c, d, f, g
Fetal - OB/GYN	✓	✓	✓	✓	—	B+M; B+PWD; B+C; (B+C)+PWD	c, f

The system transmits ultrasound energy into the patient's body to obtain ultrasound images as described in the following table.

Table 12. Clinical application descriptions

Clinical application	Description	Exam types
Abdominal	You can assess the liver, kidneys, pancreas, spleen, gallbladder, bile ducts, transplanted organs, abdominal vessels, and surrounding anatomical structures for the presence or absence of pathology transabdominally. You can assist with the performance of interventional abdominal procedures and evaluate hemodynamic blood flow in abdominal organs.	Abdomen, Procedural Abdomen
Adult cephalic	You can assess the anatomical structures and vascular anatomy of the brain for the presence or absence of pathology. You can use imaging temporally, transoccipitally, or transorbitally.	Orbital, Transcranial
 WARNING To avoid injury to the patient, use only the Ophthalmic or Orbital exam type when performing imaging through the eye. The FDA has established lower acoustic energy limits for ophthalmic use. The system will not exceed these limits if the Ophthalmic or Orbital exam type is selected.		
Cardiac adult	You can assess the cardiac valves, the great vessels, chamber size and volume, cardiac function, hemodynamic assessment, and surrounding anatomical structures for the presence or absence of pathology. You can detect normal lung motion for the presence or absence of pathology.	Cardiac, Focused Cardiac, Lung
Cardiac pediatric	You can assess the cardiac valves, the great vessels, chamber size and volume, cardiac function, hemodynamic assessment, and surrounding anatomical structures for the presence or absence of pathology. You can detect normal lung motion for the presence or absence of pathology.	Cardiac, Focused Cardiac, Lung

Clinical application	Description	Exam types
Fetal -OB/GYN	<p>You can assess the fetal anatomy, viability, estimated fetal weight, fetal heart rate, fetal position, gestational age, amniotic fluid, and surrounding anatomical structures for the presence or absence of pathology transabdominally.</p> <p>You can evaluate the blood flow of the fetus, placenta, umbilical cord, and surrounding maternal structures.</p> <p>Color Power Doppler (CPD) and Color Velocity Doppler (CVD) imaging tools are intended to evaluate the blood flow of the fetus, placenta, umbilical cord, and surrounding maternal structures in all cases, including high-risk pregnancies. High-risk pregnancy indications include, but are not limited to, multiple pregnancies, fetal hydrops, placental abnormalities, maternal hypertension, diabetes, and lupus. CPD and Color imaging tools are not intended as a sole means of diagnosis nor as a sole method of high-risk pregnancy screening.</p>	Early OB, Gynecology, OB



WARNING

- During the first trimester, you should limit the duration of ultrasound imaging based on MI/TI. See [Acoustic Output \[195\]](#) for more information.
- CPD or Color images can be used as an adjunctive method, not as a screening tool, for the detection of structural anomalies of the fetal heart and as an adjunctive method, not as a screening tool, for the diagnosis of Intrauterine Growth Restriction (IUGR).
- To prevent injury or misdiagnosis, do not use this system for Percutaneous Umbilical Blood Sampling (PUBS) or In Vitro Fertilization (IVF). The system has not been validated to be proven effective for these two uses.

Musculoskeletal (conventional and superficial)	You can assess musculoskeletal structures, soft tissue structures, and surrounding anatomical structures for the presence or absence of pathology.	MSK, Nerve, Spine, Superficial
Ophthalmic	You can assess the ocular structures and surrounding anatomical structures for the presence or absence of pathology.	Ophthalmic, Orbital



WARNING

To avoid injury to the patient, use only the Ophthalmic or Orbital exam type when performing imaging through the eye. The FDA has established lower acoustic energy limits for ophthalmic use. The system will not exceed these limits if the Ophthalmic or Orbital exam type is selected.

Pediatric	You can assess the pediatric and neonatal abdominal, pelvic, and cardiac anatomy, pediatric hips, neonatal head, and surrounding anatomical structures for the presence or absence of pathology.	Abdomen, Arterial, MSK, PIV, Superficial, Vascular Access, Venous
Peripheral vessel	You can assess the carotid arteries, deep veins and arteries in the arms and legs, superficial vessels in the arms and legs, great vessels in the abdomen, and various small vessels feeding organs for the presence or absence of pathology.	Arterial, Carotid, PIV, Vascular Access, Venous
Small organs (breast, thyroid, testicles, prostate)	You can assess the breast, prostate, thyroid, testicles, lymph nodes, hernias, soft tissue structures, and surrounding anatomical structures for the presence or absence of pathology. You can demonstrate blood flow in superficial anatomical structures.	Breast, Superficial

Clinical application	Description	Exam types
Transesophageal (cardiac)	You can assess the cardiac valves, the great vessels, chamber size and volume, cardiac function, hemodynamic assessment, and surrounding anatomical structures for the presence or absence of pathology.	Cardiac, Cardiac Resuscitation
Transrectal	You can assess the prostate and surrounding anatomical structures for the presence or absence of pathology. You can assess blood flow in the prostate.	Prostate
Transvaginal	<p>You can assess the uterus, ovaries, adnexa, and surrounding anatomical structures for the presence or absence of pathology transvaginally. You can assess blood flow in pelvic organs transvaginally.</p> <p>During early OB, you can assess the fetal anatomy, viability, fetal heart rate, fetal position, gestational age, amniotic fluid, and surrounding anatomical structures for the presence or absence of pathology transvaginally.</p> <p>You can evaluate the blood flow of the fetus, placenta, umbilical cord, and surrounding maternal structures.</p> <p>Color Power Doppler (CPD) and Color Velocity Doppler (CVD) imaging tools are intended to evaluate the blood flow of the fetus, placenta, umbilical cord, and surrounding maternal structures in all cases, including high-risk pregnancies. High-risk pregnancy indications include, but are not limited to, multiple pregnancies, fetal hydrops, placental abnormalities, maternal hypertension, diabetes, and lupus. CPD and Color imaging tools are not intended as a sole means of diagnosis nor as a sole method of high-risk pregnancy screening.</p>	Gynecology, Early OB, OB



WARNING

- During the first trimester, you should limit the duration of ultrasound imaging based on MI/TI. See [Acoustic Output \[195\]](#) for more information.
- CPD or Color images can be used as an adjunctive method, not as a screening tool, for the detection of structural anomalies of the fetal heart and as an adjunctive method, not as a screening tool, for the diagnosis of Intrauterine Growth Restriction (IUGR).
- To prevent injury or misdiagnosis, do not use this system for Percutaneous Umbilical Blood Sampling (PUBS) or In Vitro Fertilization (IVF). The system has not been validated to be proven effective for these two uses.

Biometric Measurements

You can perform the following clinical measurements on the Sonosite ST ultrasound system.

Calculations include:

- Volume
- Volume flow
- Cardiac
- Carotid
- Obstetrics
- Ratios
- Percent reduction

Measurements and their references include:

- Cardiac measurements
- Obstetrical measurements
- General measurements (such as distance, area, velocity, slope, and VTI)

Measurement and analysis performance encompasses the accuracy of the caliper measurements as well as the accuracy of algorithms used to further analyze the measurements. The accuracy values require that the operator can place the caliper marker over one pixel. The values do not include acoustical anomalies of the body. Other limitations and assumptions for measurement performance are given in [Sources of measurement errors \[130\]](#).

Accuracy of each clinical measurement possible and the range over which this accuracy can be expected to be maintained are also found in [Sources of measurement errors \[130\]](#).

Contraindications

The ultrasound system has no known contraindications.

Getting Started



WARNING

Do not use the system if it exhibits erratic or inconsistent behavior. Such behavior could indicate a hardware failure. Contact FUJIFILM Sonosite Technical Support.

About the Sonosite ST system

The ultrasound system is a portable device that acquires and displays high-resolution, real-time ultrasound images. Features available depend on your system configuration, hardware and software version, transducer, and exam type.

Basic operating steps

1. Connect a transducer. See [Preparing transducers \[25\]](#).
2. Turn on the system. See [Turning the system on and off \[19\]](#).
3. Select the transducer and exam type, or use the default selections. See [Selecting a transducer and exam type \[26\]](#).
4. (Optional) Enter patient information. See [Entering Patient Information \[61\]](#).
5. Scan. See [Scanning \[68\]](#).

Hardware features

Figure 1. Sonosite ST

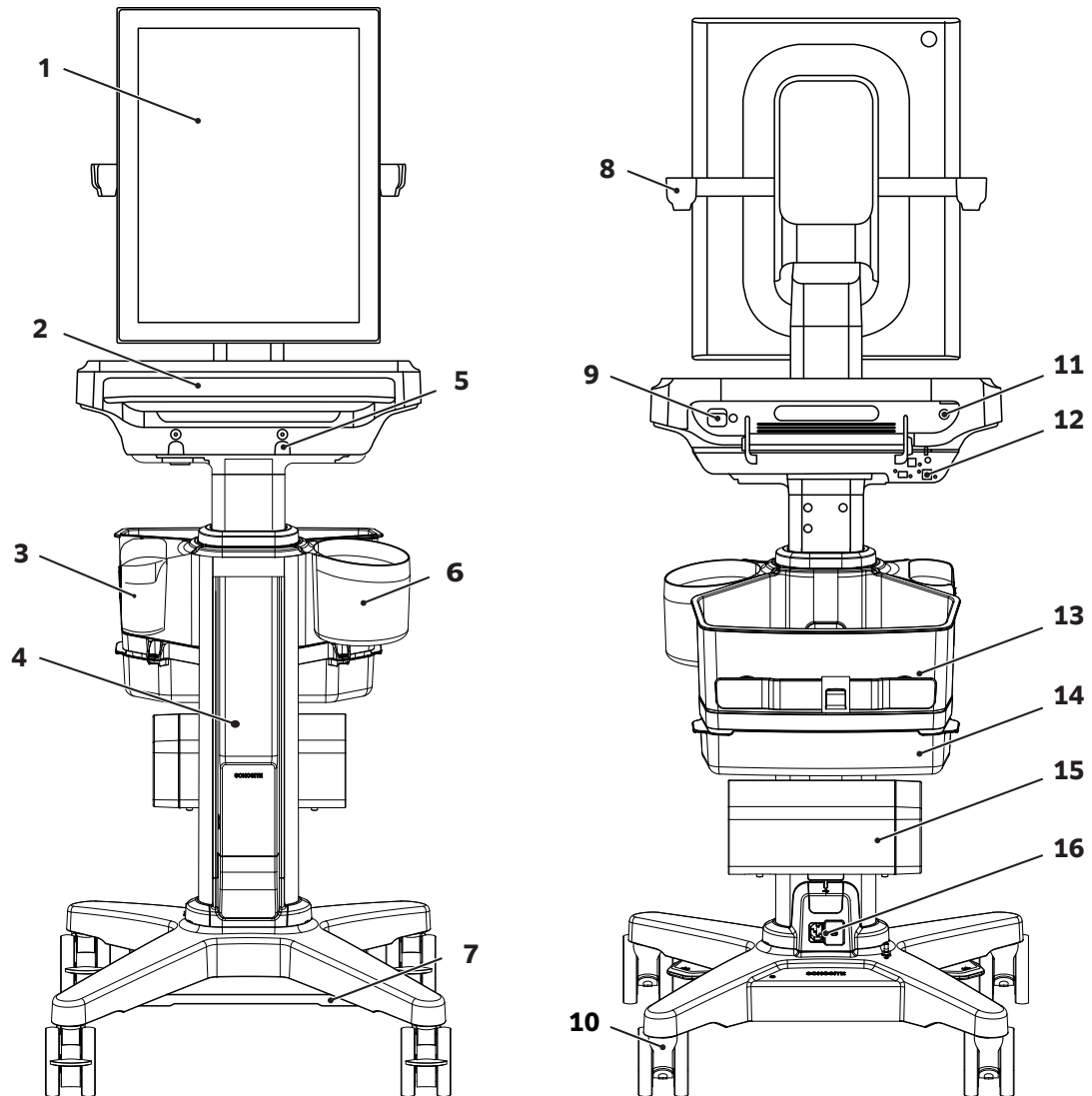

Front view		Back view	
1.	Clinical monitor with touchscreen	8.	Transducer holder
2.	Tray and monitor mount	9.	System USB ports
3.	Gel holder	10.	Locking wheels
4.	Stand battery	11.	Power on/off button
5.	Transducer connector port	12.	Video out and network ports
6.	Wipes holder	13.	Rear storage bin with cord wrap
7.	Height adjustment pedal	14.	Lockable storage drawer
		15.	Printer

Front view	Back view
	16. AC power ports

Accessories and peripherals



WARNING

Use only accessories and peripherals recommended by FUJIFILM Sonosite, including the power supply. Connection of accessories and peripherals not recommended by FUJIFILM Sonosite could result in electrical shock and system malfunction. Contact FUJIFILM Sonosite or your local representative for a list of accessories and peripherals available from or recommended by FUJIFILM Sonosite.

The ultrasound system is designed to support a variety of accessories and peripherals. For a complete list, see [Compatible accessories and peripherals \[182\]](#).

Preparing the system

Adjusting the system or stand



WARNING

Lock the stand wheels whenever the system is unattended or stationary.

Do any of the following:

- To lock or unlock a wheel, press down the lever on the wheel or press up on the bottom of the lever.
- To raise or lower the stand head or platform, press down the height-adjustment pedal located at the bottom of the stand while grasping both sides of the platform and pushing it up or down.
- To adjust the clinical monitor, grasp the monitor on both sides and tilt it forwards or backwards.

Removing or installing the Sonosite ST system



CAUTION

Disconnect any devices attached to the ultrasound system before removing it from the stand. Failure to disconnect attached devices may result in damage to the system or accessories.



CAUTION

Turn off the system before removing the ultrasound system from the stand. Removing the ultrasound system from the stand while the system is powered on may damage the dock.

1. Loosen the connection between the system and the built-in transducer connector by pulling the latch down and then rotating it.

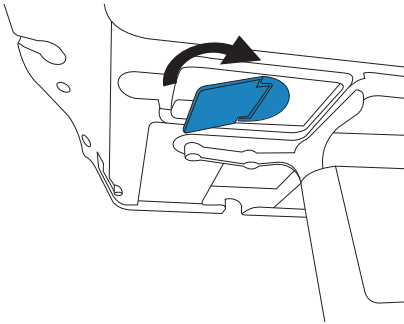

2. Use the plastic pry tool to remove the cover on the center of the monitor mount and tray.

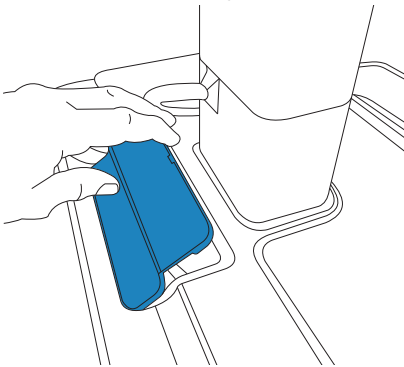

3. Detach the video cable and rotate the safety latch.

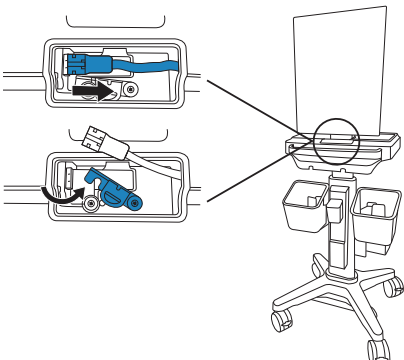

4. Use the 3 mm hex bit to remove the four screws that secure the monitor mount and tray to the stand head.

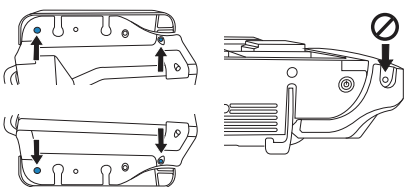

- Carefully lift off the monitor mount and tray with the monitor attached. Set it aside in a safe place.

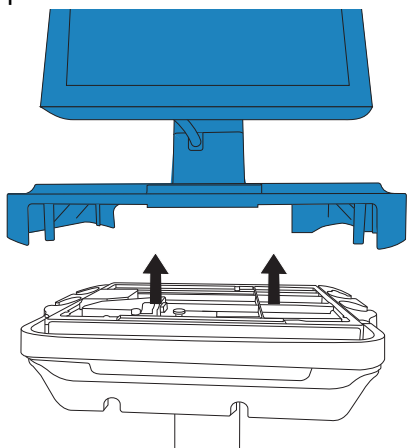

- Lift the two rear latches and then lift the system away from the stand.

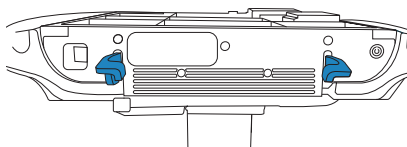

- To install the system, follow the steps in reverse order.

Transporting the system

- Secure the transducers and check that the cables are clear of the floor.
- Adjust the height of the system to the lowest position.
- You can tilt the clinical monitor back for improved visibility.
- To wheel the system, unlock the stand's wheels and then push forward on the handle located on the back of the stand.

Powering the system

The system can be powered by internal battery, stand battery, or by AC power.



WARNING

- Verify that the hospital AC mains supply voltage corresponds to the power supply voltage range.
- Plug the system only into a grounded hospital-grade AC mains outlet.
- Use only power cords provided with the system by FUJIFILM Sonosite.



CAUTION

- Do not use the system if an error message appears on the clinical monitor. Note the error code and turn off the system. Call FUJIFILM Sonosite or your local representative.
- When using AC power, position the system to allow easy access to unplug it from the AC mains outlet.

Installing or replacing system batteries



WARNING

- To avoid injury to the operator and to prevent damage to the ultrasound system, inspect the batteries for leaks prior to installing.
- To avoid data loss and to conduct a safe system shutdown, do not operate the system without batteries installed.



CAUTION

To ensure proper operation of the stand battery and ultrasound system, always have the system batteries in the ultrasound system.

1. Make sure the ultrasound system is off.
2. If applicable, disconnect the power supply.
3. Remove the system from the stand. See [Removing or installing the Sonosite ST system \[13\]](#).
4. Turn the system upside down.
5. Use a Phillips screwdriver to remove the screws and then the cover to the battery compartment.

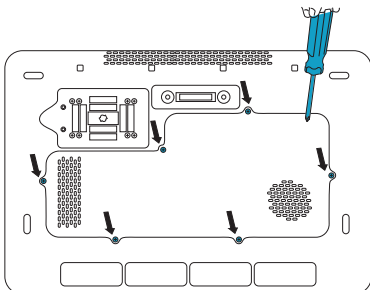

6. Place the first battery in the battery compartment as shown, then plug its cable into the connector. Make sure the cable is placed fully within the compartment.

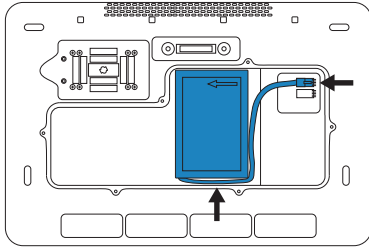

7. Place the second battery in the battery compartment as shown, then plug its cable into the connector. Make sure the cable is placed fully within the compartment.

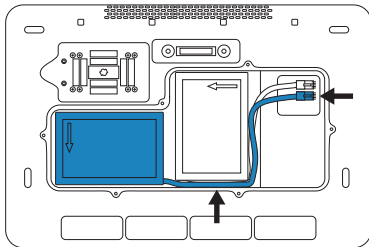

8. Replace the cover and then use the screwdriver to reinstall the screws.

Power and battery indicators



CAUTION

- Connect the system to AC power when the battery charge is low.
- The batteries contain technology that requires periodic recharging to maintain optimal performance. If left uncharged for months, the battery performance could degrade or become non-functional. Recharge the batteries by connecting the system to AC power.
- Periodically check to make sure that the batteries charge. If the batteries fail to charge, contact FUJIFILM Sonosite Technical Support.
- Use only FUJIFILM Sonosite batteries with the system.





NOTE

If the system does not maintain expected battery charge, or if the battery icon on the clinical monitor does not display the battery charge status, disconnect and reconnect the system to AC power.

Icons in the system status area on the clinical monitor and lights on the system and stand show the power and battery status.

Battery status is also displayed on the Power and Battery settings page. See [Power and battery settings \[55\]](#).

Table 13. Power and battery indicators

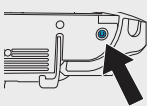
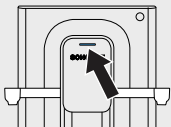
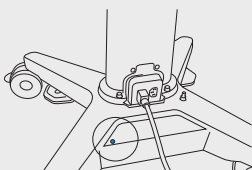
Indicator	Status
	<p>The system is unplugged, and the battery is in use. The level of battery charge corresponds to the length of the bar. When the battery charge is low, the color of the bar changes to yellow. At a charge of approximately 5% or lower, the color changes to orange, and the system beeps and displays a warning message. If Beep alert is on (see Adjusting audio settings [42]), the system beeps when the battery charge is below 15%.</p>
	<p>The system is on AC power, and the batteries are charging.</p>
	<p>The system is on AC power only (no battery available).</p>
<p>Power button</p> 	<p>Yellow indicates that the system is booting, green indicates that the system is on, and blinking green indicates that the system is asleep.</p> <p>A blinking amber light means that performance mode is enabled. See Specifying power settings [55].</p>
 <p>Light on the back of the touchscreen</p>	<p>The blue lights turn on when the system is off or asleep. A solid light means the system is connected to AC power and the batteries are fully charged. When the lights fade in and out, the system is connected to AC power and the batteries are charging.</p> <p>If the system is not connected to AC power, the lights blink in a pattern that changes based on the battery charge level:</p> <ul style="list-style-type: none"> • One blink indicates > 10% charge • Two blinks indicate > 40% charge • Three blinks indicate > 70% charge <p>If the lights are not on, the system is either awake or not receiving any power.</p>
<p>Light on the stand base</p> 	<p>The light is on when the stand is receiving power.</p>
<p>Light next to the stand/system connector</p>	<p>The light is on when the system is receiving power through the stand.</p>

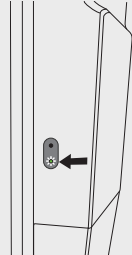
Indicator	Status
<p>Lights on the stand battery</p> 	<p>The bottom light turns green when the stand is plugged in and the battery is receiving power. An upper red light indicates that something is wrong with the battery or that the stand is receiving too much power.</p> <p>If the ultrasound system is not docked to the stand, the blue upper light blinks when the stand is plugged in and the battery is charging. When the battery is fully charged, the light remains on but stops blinking.</p>

Turning the system on and off

1. If you are operating the system using AC power, connect the stand's AC power cord to a hospital-grade AC mains outlet and make sure that the stand indicator lights are on.
2. If you are operating the system using battery power, check the indicator lights on the system or stand.
3. Press the power button .
4. To turn the system off, press the power button again.

The system will power down when your data is safe. Any in-progress transfers will complete when power is restored. Turning off the system logs you out and ends the active study. If the system appears unresponsive, wait several minutes before restarting it. Restarting the system while it is performing data-intensive background activities, such as transferring patient files, can result in loss of patient data. To power down an unresponsive system, press and hold the power button until the system shuts down. This procedure may take five seconds or longer.

Putting the system into sleep mode

To conserve battery power, the system enters sleep mode after a period of inactivity. To specify the period of inactivity before the system goes into sleep mode, see [Specifying power settings \[55\]](#).

To put the system immediately into sleep mode, tap **Sleep** from the system menu . You can wake the system up by tapping the touchscreen.

Inserting and removing USB devices

You can use the USB ports on the system for connecting devices such as a USB storage device. Use USB storage devices to export patient data and logs. An administrative user can also import and export user accounts and setup configurations.



WARNING

Use only accessories and peripherals recommended by FUJIFILM Sonosite. Connection of accessories and peripherals not recommended by FUJIFILM Sonosite could result in electrical shock and system malfunction. Contact FUJIFILM Sonosite or your local representative for a list of accessories and peripherals available from or recommended by FUJIFILM Sonosite.





CAUTION

- To avoid losing data from or damaging the USB storage device, do not remove the USB storage device or turn off the ultrasound system while exporting. In addition, do not bump or apply pressure to the USB storage device while it is connected to the system. The connector could break.
- If the USB icon  does not appear in the system status area on the monitor, the USB storage device may be defective. Replace the USB storage device.
- Do not remove the system's internal storage device. Data on the device is encrypted for HIPAA compliance and will be lost if the device is removed. The internal storage device should be removed for service purposes only.



NOTE

To protect patient confidentiality, remove all identifying information from patient images, files, or records before sending electronically.

1. Insert the USB storage device into a USB port on the system.
The USB storage device is ready when the USB icon  appears on-screen.
2. If exporting, wait at least five seconds after the USB animation icon  stops.
3. Remove the USB storage device from the port.

Disconnecting the USB storage device while the system is exporting to it may cause the exported files to be corrupted or incomplete.

General interaction

Once a new Sonosite ST is configured, a startup screen displays when you turn the system on. See [Configuring the system for the first time \[31\]](#).

Figure 2. Startup screen

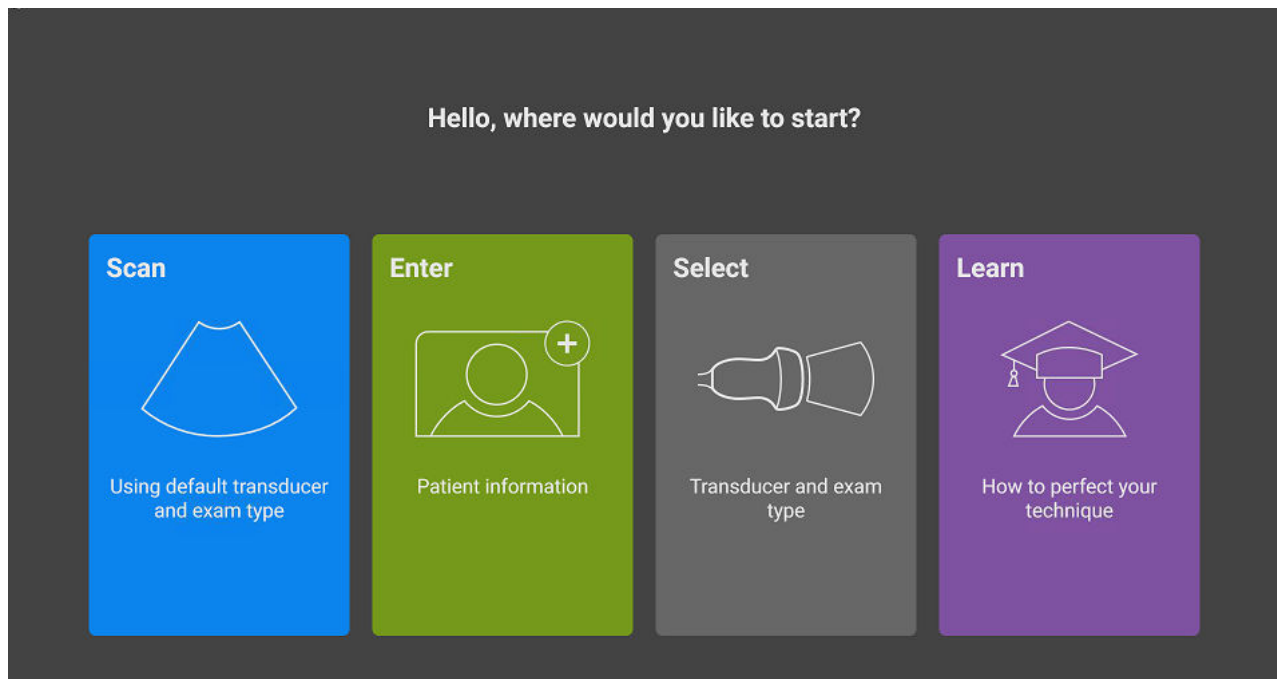

The system has four main modules that are accessible from the startup screen:

- **Scan** - This module is where you perform patient exams.
- **Enter** - This module lets you access the patient information form, where you can enter patient information, search for a patient, view the scheduled list of patients, and select a study.
- **Select** - This module is where you select the combination of transducer and exam type to use for your scan.
- **Learn** - This module contains scan-along educational tutorials for ultrasound.

You can choose some of these modules as your startup screen. See [Choosing a startup mode \[56\]](#).

Clinical monitor

The Sonosite ST clinical monitor is a touchscreen enabling you to interact directly with objects on the screen similar to many other touchscreen devices.

You can use the touchscreen to adjust settings; select the exam type, transducer, and imaging mode; enter patient information; and more.

The clinical monitor displays the ultrasound image as well as details about the exam and system status.



WARNING

- FUJIFILM Sonosite does not recommend using a monitor other than the clinical monitor provided by FUJIFILM Sonosite. Only the images presented on the clinical monitor are validated for the intended use of the device.
- Do not use a monitor connected through the digital video out port for medical diagnosis.

Figure 3. Clinical monitor layout

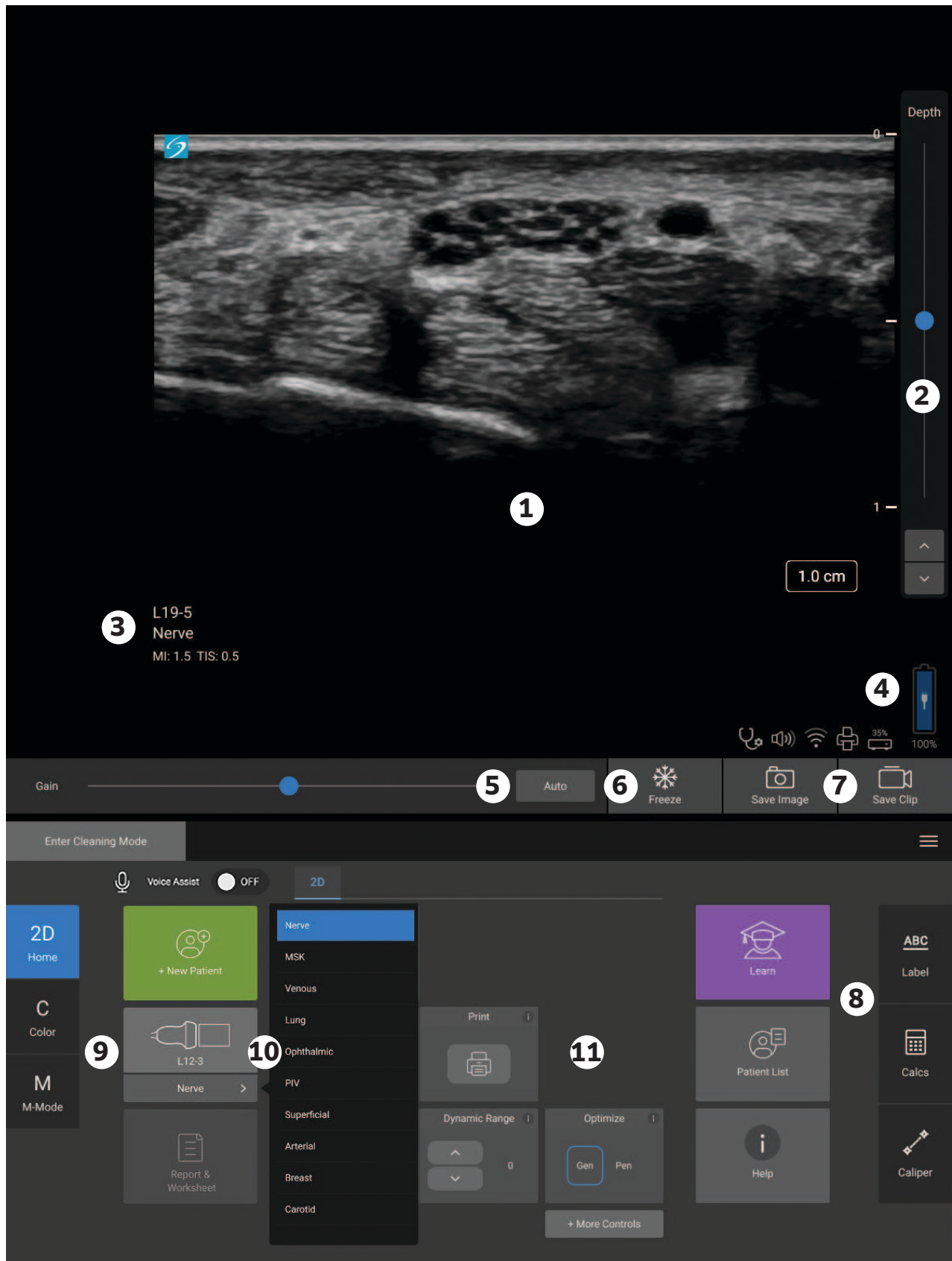

1.	Clinical monitor and touchscreen	7.	Save buttons
2.	Depth controls	8.	Labels, Calcs, Calipers
3.	Exam type	9.	Modes
4.	Battery level and connections	10.	Patient, transducer and exam selector, reports and worksheets
5.	Gain or cine controls	11.	More controls
6.	Freeze		

Digital video output



WARNING

- To avoid possible electrical shock or electromagnetic interference, verify proper operation and compliance with relevant safety standards for all equipment before clinical use. Connecting additional equipment to the ultrasound system constitutes configuring a medical system. FUJIFILM Sonosite recommends verifying that the system, all combinations of equipment, and accessories connected to the ultrasound system comply with relevant installation requirements and safety standards.
- For safety, FUJIFILM Sonosite recommends isolating auxiliary video connections with external devices; for example, optical or wireless interface adapters. Check the electrical safety of your system with a trained biomedical engineer prior to use.

Digital video output resolution is 1600 x 1200 px at 60 Hz.



Voice activated controls



Voice Assist requires that the FUJIFILM Sonosite microphone is connected to a USB port on the system. While maintaining sterile hands and gloves, you can use a fixed number of voice commands to perform certain functions instead of pressing or tapping system controls although touch interactions are still available.

The ultrasound system understands only English commands although it can recognize a variety of different accents. For a list of the voice commands available on the system, see [Voice commands \[79\]](#). To use the voice commands, see [Using voice commands \[79\]](#).

On-screen keyboard

You can enter text into text boxes (for example, on the patient form) using the on-screen keyboard.

1. Tap a text box or tap **ABC**.
In most contexts, the on-screen keyboard appears. If you are entering a label, you may need to tap .
2. Tap keys as needed:
 - Tap the shift key  to change an alphabet key to an uppercase character.
 - Tap the caps lock key  to change all the keys to uppercase characters.

- When filling in a form, tap **next** or the tab key  to advance to the next text box.
- When filling in a form, tap **previous** to jump to the previous text box.
- Tap **123*#** to display keys for numbers, symbols, and special characters.
- Tap **abc** to return to the alphabet keys.
- When filling in a form, hold down an alphabet key to reveal accented characters.
- Tap  to delete a character on the left side of the pointer.
- Tap  to close the keyboard. In certain contexts, the return key also closes the keyboard.

Preparing transducers



WARNING

- Some gels and sterilants can cause an allergic reaction on some individuals.
- Some transducer sheaths contain natural rubber latex and talc, which can cause allergic reactions in some individuals. FUJIFILM Sonosite recommends that you identify your latex and talc-sensitive patients and be prepared to treat allergic reactions promptly.



CAUTION

- To avoid damage to the transducer, use only gels recommended by FUJIFILM Sonosite. Using other gels can damage the transducer and void the warranty. If you have questions about gel compatibility, contact FUJIFILM Sonosite or your local representative.
- Clean transducers after each use.

Connecting transducers

Sonosite ST supports connecting up to two transducers simultaneously.

1. Pull the transducer latch handle up and rotate it clockwise.
2. Insert the transducer connector into one of the transducer ports on the system.
3. Make sure that the connector is firmly seated, and then turn the latch counterclockwise.
4. Press the latch handle up, securing the transducer to the system.

Removing a transducer



CAUTION

To avoid equipment damage that could lead to image quality degradation, do not disconnect a transducer while it is in use. Either freeze the image or switch to another transducer before disconnecting.

1. Pull the transducer latch up, and rotate it until loose.
2. Pull the transducer connector away from the system.

Selecting a transducer and exam type



WARNING

To prevent misdiagnosis or harm to the patient, use the correct transducer for the application. The diagnostic capability differs for each transducer, exam type, and imaging mode. Transducers are developed to specific criteria depending on their physical application. These criteria include biocompatibility requirements. Understand the system's capabilities prior to use.

Before scanning, select a transducer and exam type. Exam types are predefined groups of scanning settings optimized for a clinical use.

1. Do one of the following:
 - On the startup screen, tap **Select Transducer and Exam type**.
 - In the patient form, tap the current transducer and exam button.
 - While scanning, tap the current transducer button to switch transducers or tap the exam type to select a different exam type from the fly-out menu.
2. If switching transducers, select an exam type on the appropriate transducer card:
 - Double-tap the exam type to begin scanning in that exam type.
 - Tap the exam type, and then tap **Scan** or tap **Cancel** to cancel. Scrolling the list of exam types displays any hidden items.



NOTE

The Orbital and Transcranial exam types require Doppler imaging and are only available in some countries with the licensed Doppler option.

Table 14. Imaging modes and exam types on transducers

Transducer	Exam type	Imaging mode			
		2D, M Mode	Color ^a	PW Doppler ^b	CW Doppler
C5-1 ^c	Abdomen	✓	CVD, CPD	✓	—
	Early OB	✓	CVD, CPD	✓	—
	Gynecology	✓	CVD, CPD	✓	—
	Lung	✓	CVD, CPD	✓	—
	Musculoskeletal (MSK)	✓	CVD, CPD	✓	—
	Nerve	✓	CVD, CPD	✓	—
	Obstetrics (OB)	✓	CVD, CPD	✓	—
	Procedural Abdomen	✓	CVD, CPD	✓	—
	Spine	✓	CVD, CPD	✓	—

Transducer	Exam type	Imaging mode			
		2D, M Mode	Color ^a	PW Doppler ^b	CW Doppler
C10-3 ^c	Abdomen	✓	CVD, CPD	✓	—
	Gynecology	✓	CVD, CPD	✓	—
	Lung	✓	CVD, CPD	✓	—
	Musculoskeletal (MSK)	✓	CVD, CPD	✓	—
	Nerve	✓	CVD, CPD	✓	—
	Spine	✓	CVD, CPD	✓	—
IC10-3 ^c	Early OB	✓	CVD, CPD	✓	—
	Gynecology	✓	CVD, CPD	✓	—
	Obstetrics (OB)	✓	CVD, CPD	✓	—
	Prostate	✓	CVD, CPD	✓	—
L12-3 ^c	Arterial ^d	✓	CVD, CPD	✓	—
	Breast	✓	CVD, CPD	✓	—
	Carotid ^d	✓	CVD, CPD	✓	—
	Lung	✓	CVD, CPD	✓	—
	Musculoskeletal (MSK)	✓	CVD, CPD	✓	—
	Nerve	✓	CVD, CPD	✓	—
	Ophthalmic	✓	CVD, CPD	✓	—
	PIV ^{d,e}	✓	CVD, CPD	✓	—
	Superficial	✓	CVD, CPD	✓	—
	Venous ^d	✓	CVD, CPD	✓	—
L13-6	Musculoskeletal (MSK)	✓	CVD, CPD	✓	—
	PIV ^{d,e}	✓	CVD, CPD	✓	—
	Superficial	✓	CVD, CPD	✓	—
	Venous ^d	✓	CVD, CPD	✓	—
L15-4 ^c	Arterial ^d	✓	CVD, CPD	✓	—
	Breast	✓	CVD, CPD	✓	—
	Carotid ^d	✓	CVD, CPD	✓	—
	Musculoskeletal (MSK)	✓	CVD, CPD	✓	—
	Nerve	✓	CVD, CPD	✓	—
	Superficial	✓	CVD, CPD	✓	—
	Venous ^d	✓	CVD, CPD	✓	—
L19-5 ^c	Arterial ^d	✓	CVD, CPD	✓	—
	Lung	✓	CVD, CPD	✓	—
	Musculoskeletal (MSK)	✓	CVD, CPD	✓	—
	Nerve	✓	CVD, CPD	✓	—
	Ophthalmic	✓	CVD, CPD	✓	—
	PIV ^{d,e}	✓	CVD, CPD	✓	—
	Superficial	✓	CVD, CPD	✓	—
	Venous ^d	✓	CVD, CPD	✓	—
Vascular Access ^d	✓	CVD, CPD	✓	—	
P5-1	Abdomen	✓	CVD, CPD	✓	—
	Cardiac	✓	CVD, Var	✓	✓
	Focused Cardiac	✓	CVD, Var	✓	✓
	Lung	✓	CVD, CPD	✓	—

Transducer	Exam type	Imaging mode			
		2D, M Mode	Color ^a	PW Doppler ^b	CW Doppler
	Obstetrics (OB)	✓	CVD, CPD	✓	—
	Orbital	✓	CVD, CPD	✓	—
	Transcranial	✓	CVD, CPD	✓	—

^aColor Doppler Variance (Var) is available in the cardiac exam only. Color Power Doppler (CPD) is available in all exams except the cardiac exam type. CVD = Color Velocity Doppler

^bFor the cardiac exam types, PW TDI is also available

^cNeedle guide-capable. For more information, refer to Using CIVCO Products with FUJIFILM Sonosite Systems.

^dAvailable with simultaneous Doppler imaging.

^ePIV = Peripheral intravenous. Use this exam type for better needle visualization during PIV procedures.

Gel

Use acoustic coupling gel on the transducer during exams. Although most gels provide suitable acoustic coupling, some gels are incompatible with some transducer materials. FUJIFILM Sonosite recommends Aquasonic gel and provides a sample with the system.

For general use, apply a liberal amount of gel between the transducer and the body. For interventional use, apply a transducer sheath.

Sheaths



WARNING

Use market-cleared, sterile transducer sheaths and sterile coupling gel for transrectal, transvaginal, or guided-needle procedures. Do not apply the transducer sheath and coupling gel until you are ready to perform the procedure. After use, remove and discard the single-use sheath, and clean and disinfect the transducer using a FUJIFILM Sonosite-approved disinfectant.

Applying a transducer sheath

1. Place gel inside the sheath. Make sure that the gel is at the end of the sheath.
2. Insert the transducer into the sheath.
3. Pull the sheath over the transducer and cable until the sheath is fully extended.
4. Secure the sheath using the bands supplied with the sheath.
5. Check for and eliminate air bubbles between the face of the transducer and the sheath. Air bubbles between the face of the transducer and the sheath may affect the ultrasound image.
6. Inspect the sheath to ensure that there are no holes or tears.

On-board educational videos

The FUJIFILM Sonosite on-board educational videos are animated 3D videos that describe scanning techniques, terminology, and more.

Scanning is active while a video plays, so you can practice scanning techniques in conjunction with the visual guides.

Playing a video

1. Display the videos by doing one of the following:
 - Tap **Learn** on the startup screen.
 - Tap **Learn** on the touchscreen.
 - Tap **Learn** from the system menu .
2. At the top of the screen, tap a category (for example, **Basics**). The current selection is highlighted.
3. Swipe left or right on the touchscreen to show additional cards.
4. Tap a video selection from one of the cards. The video player appears.
5. Do any of the following:
 - Select a language from the **Video Language** menu.
 - Play or pause the video using the controls at the bottom of the player.
 - Tap the volume control to mute the audio. Tap again to unmute.
 - Drag the volume slider to adjust the volume.
 - Tap another video in the list to play it.
 - Tap **Back** to return to the **Learn** screen.
 - Tap **Scan Along** to play the video while scanning. The video appears on the scan screen. You can play, pause, expand, or close the video.

Configuring the System

System Settings is where you customize the system and set preferences.



NOTE

- Not all system settings are available if you log in to the system as a guest.
- Reset functions are provided on some system settings pages.

Navigating system settings



1. On the touchscreen, tap the system menu .
2. Tap **System Settings**.
3. Tap a setting from the list to display the settings page.
4. Do any of the following while in a settings page:
 - If a system settings has multiple pages, tap the **Back** button to return to the previous page.
 - Tap another system setting from the list to display its settings page (any changes you have made are saved).
 - Tap **Done** to save your changes and exit system settings.
 - Tap **Cancel** to cancel any changes.

Returning to factory defaults



CAUTION

Restoring the system to the default settings will delete all settings and patient data. Back up your data prior to performing this action.

1. To manually reset the system, do the following:
 1. Tap the system menu .
 2. Tap **System Settings**.
 3. Tap and hold the lock symbol  for 30 seconds.
2. Make sure the system is connected to AC power, and tap **Yes** to continue. Resetting the system can take up to thirty-five minutes.



NOTE

If your system does not have enough power, you will need to restart the process.

3. When the reset is complete, tap **OK** to restart the system.

Using the system as an administrator

Users with administration rights have the ability to manage users and configure certain settings and security features on the system. An administrative user can also use the configuration wizard to set up the system.

Available security settings help you to meet the applicable security requirements listed in the HIPAA standard. Users are ultimately responsible for ensuring the security and protection of all electronic protected health information collected, stored, reviewed, and transmitted on the system.



CAUTION

Healthcare providers who maintain or transmit health information are required by the Health Insurance Portability and Accountability Act (HIPAA) of 1996 and the European Union Data Protection Directive (95/46/EC) to implement appropriate procedures: to ensure the integrity and confidentiality of information and to protect against any reasonably anticipated threats or hazards to the security or integrity of the information or unauthorized uses or disclosures of the information.

Configuring the system for the first time

A new Sonosite ST system automatically launches a configuration wizard when it is first turned on. The first page of the wizard prompts you to create your administrator account. During system setup, some of the settings (such as date and time) may have been set at the factory. You can always enter other values, depending on the guidelines set by your organization.

1. Turn the machine on by pressing the power button.
The configuration wizard starts automatically.
2. On the first page, enter the administrative login information you would like to use.



NOTE

To ensure security, choose a password that contains uppercase characters (A-Z), lowercase characters (a-z), and numbers (0-9). Passwords are case-sensitive.

3. On the next page, confirm the date and time settings, modifying them as appropriate.
4. Select whether or not you want to import custom settings from another Sonosite ST system using a USB storage device containing the exported settings.
After connecting the device to your system, follow the import instructions. The wizard skips the rest of the setup process.
5. On the next page, enter your institution and departmental information.
6. Specify power and battery settings.
7. Select one of the following modes:



NOTE

You can only switch modes by running the wizard again (administrators only), which resets the system and deletes all data.



CAUTION

FUJIFILM Sonosite strongly recommends configuring the system in secure mode. Operating in non-secure mode increases the risk of being out of compliance with HIPAA regulations.

- **Secure mode:** Secure mode requires all users to log into the system and enables user management including support of a directory server. Secure mode is compliant with patient privacy regulations and enables you to connect to a directory server. If the system is in secure mode, only administrators are able to change connectivity settings and import and export system settings.
 - **Non-secure mode:** Non-secure mode allows any user to access all system functions, except administrative settings, without requiring a login.
8. The System Portal is enabled by default. To disable the System Portal, clear the check box.

The system restarts to enable the new settings.

Accessing administrative settings

To log into and out of the system and change your password, see [Logging in and out \[41\]](#). If you have forgotten your administrator password, see [Returning to factory defaults \[30\]](#) to reset the system or contact FUJIFILM Sonosite (see [Getting help \[2\]](#)).



CAUTION

Restoring the system to the default settings will delete all settings and patient data. Back up your data prior to performing this action.

1. Tap , and then tap **System Settings**.
2. To display the main administration settings page, tap **Administration** in the list on the left.
3. If prompted, type your administrative login information and tap **Login**.

Managing users on the system

Only administrators can manage user accounts, including importing user accounts from another system, creating or editing a user account, or deleting user accounts from the system.

To manage users by synchronizing with a directory server and using server-based user accounts, see [Configuring a connection to a directory server \[34\]](#).

Required fields are indicated by an asterisk (*).

Adding a new user on the system

1. Using your administrative login information, log into the administrative settings page.
2. Tap **User Management**.
3. On the user management page, tap **Add User**. Fill in the user information fields.
4. If you want to require that the user change their password, select **Require password change on next login**, and then enter a temporary password for the new user to gain initial access.



NOTE

- To ensure security, choose a password that contains uppercase characters (A-Z), lowercase characters (a-z), special characters, and numbers (0-9).
- Passwords are case-sensitive.
- The default minimum time required between changing passwords (24 minutes) could cause a conflict with requiring a user to change their password on next login.

5. If you want the user account to expire on a given date (such as accounts for students, interns, or other temporary personnel), select **Enable account expiration**, and then enter the number of days (such as 90) until the account will expire into the **Set account expiration in days** field.
6. When you have finished configuring the new user account, tap **Save to database**.

Editing a user

1. Using your administrative login information, log into the administrative settings page.
2. Tap **User Management**.
3. Tap the user account in the list, then tap **Edit User**.
4. Make the desired changes to the user information fields.



NOTE

Although you can change the first or last name of a user, you cannot modify the user account name once it has been created.

5. When you have finished modifying the user account, tap **Save to database**.

Changing a user password

1. Using your administrative login information, log into the administrative settings page.
2. Tap **User Management**.
3. Tap the user account in the list, then tap **Edit User**.
4. Select **Reset password**.
5. Type the new password in the **Password** text box and in the **Confirm** text box.



NOTE

The password typed in both fields must match.

Enabling a disabled user account

1. Using your administrative login information, log into the administrative settings page.
2. Tap **User Management**.
3. Tap the user account in the list, then tap **Edit User**.
4. Set the user **Status** to **Active**.

Deleting a user

1. On the user management page, tap the user account in the list.
2. Tap **Delete User**.
3. Tap **Yes**.

Configuring a connection to a directory server

In order to use server-based user accounts, you must configure the system in secure mode (see [Configuring the system for the first time \[31\]](#)). We recommend consulting an IT administrator for the following procedure.

1. Using your administrative login information, log into the administrative settings page.
2. Tap **LDAP/AD**.
3. Select **Use LDAP/AD authentication**.



NOTE

Enabling a connection to a corporate directory server disables local account creation. You can continue to use pre-existing local user accounts, but you cannot add new local accounts while this setting is enabled.

4. In the **Remote server** field, type the Fully Qualified Domain Name (FQDN) Address or IP address of the directory server.
5. In the **Port** field, type the port number of the directory server.
The default port for LDAP is 389. The default port for LDAPS is 636. Your directory server port number could be different.
6. To encrypt the communication between the ultrasound system and the directory server using Transport Layer Security (TLS), tap the check box next to **Secured** (not checking this box could compromise any passwords used on the system).
If using TLS with a private certificate authority (CA), you must first import the private root CA certificate (see [Managing certificates \[40\]](#)).
7. In the **Search root** field, type the Distinguished Name of the root directory.
The Distinguished Name is normally the same as the domain name, expressed in X.500 "attribute=value" format per RFC-2253.
8. In the **User DN** field, type the Distinguished Name of the user directory that you wish to search.



NOTE

Normally, you read the directory path that stores the user accounts in reverse order.

9. In the **Domain name** field, type the domain name component (typically the subdomain of the DNS domain name) that should be added to the front of a user account name in order for the directory lookup to succeed.
10. When you've finished configuring your connection, tap **Test Connection**.



NOTE

If the connection fails, make sure that you have entered the correct information and that there are no issues with the network or server.

11. Tap **Save**.

Managing password requirements

Administrators can define the complexity of user account passwords, including the types of required characters, length of the password, and lock-out policies after multiple unsuccessful login attempts. Password requirements defined on the system only apply to local user accounts.

1. Using your administrative login information, log into the administrative settings page.
2. Tap **Password Rules**.
3. Under **Password complexity**, select the desired combination of parameters for password complexity.
4. Use **Minimum length** and **Maximum length** to control how short or long passwords should be.
5. If you want to change the minimum default password duration value of 24 minutes, enter a value into the **Min duration for password to be active (mins)** field.
6. If you want to limit reuse of passwords, enter the number of times a person can reuse a previous password into the **Enforce password history count** field.
7. If you want passwords to be changed periodically, enter the number of days until password expiration into the **Password expires in (days)** field.
8. Enter the number of unsuccessful attempts a person can enter before the system prevents them from attempting to log in again into the **Account lock-out threshold (unsuccessful attempts)** field.
9. Enter the length of time (in minutes) that a user will be prevented from attempting to log in after they've been locked out into the **Account lock-out duration (mins)** field.

Protecting patient information



NOTE

To protect patient confidentiality, remove all identifying information from patient images, files, or records before sending electronically.

You can configure the system to require a user name and password at startup. If you require user login, set up local user accounts on the system or connect to a directory server to access accounts.

To help protect sensitive patient information, you can choose not to display the patient name and ID number on the monitor and to remove it from exported images and video clips. You can also delete patient data from the system.

Hiding patient information

1. Using your administrative login information, log into the administrative settings page.
2. Tap **Admin Settings**.
3. To hide patient information on the monitor, ensure that the **Hide patient information on clinical monitor** check box is selected.
4. To hide patient information in exported data, ensure that the **Hide patient information on export** check box is selected.

Removing all patient data from the system



CAUTION

Back up patient data prior to performing this action.

1. Using your administrative login information, log into the administrative settings page.
2. Tap **Admin Settings**.
3. Tap **Delete All Patient Data**.
4. Make sure the system is connected to AC power, and then tap **Yes** to continue. Deleting patient data takes approximately thirty-five minutes.



NOTE

If your system does not have enough power, you will need to restart the process.

5. When the wipe is complete, tap **OK** to restart the system.

Controlling data import and export

Administrators can control the export of data to an attached USB storage device or block access to USB storage devices and networks.

1. Using your administrative login information, log into the administrative settings page.
2. Tap **Admin Settings**.
3. To control export to a USB storage device, do one of the following:
 - If you want to allow exporting data, select the **Enable export to USB** check box.
 - If you want to prevent exporting data, deselect the **Enable export to USB** check box.
4. To restrict access to a network or device, do any of the following under **Enabled IO devices**:
 - If you want to restrict wireless network access, deselect the **Wifi** check box.
 - If you want to restrict Ethernet network access, deselect the **Ethernet** check box.
 - If you want to prevent any USB device from connecting to the system, deselect the **USB devices** check box.

Creating a sign-in notification

Administrators can create a notification or other message that users will see when they log in to the system. The message can be configured to display only the first time a new user logs in, or it can be configured to appear every time users sign in.

1. Using your administrative login information, log into the administrative settings page.
2. Tap **Admin Settings**.
3. Select the **Enable system use notification** check box, and then enter the text for your notification.
4. Select the appropriate option to display the notification: either each time a user logs in, or only the first time a new user logs in.

Configuring internal storage settings

The administrator can set up how the system manages internal storage by configuring auto delete settings and internal storage alerts.

Your auto delete settings must be compatible with your DICOM settings. If you have set up a storage commit server, make sure that the system is auto-deleting storage committed studies only. If only an archive server is set up, you can allow the system to delete archived studies. Otherwise, you may select the all studies option.

Configuring auto delete settings

1. Using your administrative login information, log into the administrative settings page.
2. Tap **Auto Delete**.
The auto delete settings page appears.
3. Under **Auto Delete**, select one of these choices:
 - **On**
 - **Off (manual)**
This is the default option.
4. Select the type of study to delete:
 - **Storage Committed studies only**
 - **Archived studies only**
 - **All studies**
5. Select the age of the studies to delete:
 - **24 hours old**
 - **3 days old**
 - **7 days old**
 - **28 days old**
6. Tap **Save** and confirm your selection.
Auto delete will occur daily at midnight or at first boot up.

Receiving storage alerts

On the auto delete settings page, select **Internal storage capacity alert**.

The system displays a message if internal storage is near capacity when a user ends a study.



CAUTION

If the save available icon  does not appear in the system status area, internal storage may be defective. Contact FUJIFILM Sonosite Technical Support.

Configuring remote worksheet access

The ultrasound system supports custom and default worksheets available from the ultrasound workflow application Sonosite Synchronicity Workflow Manager. As an administrator, you can configure the system to access the remote worksheets server. See [Configuring the system for DICOM transfer \[43\]](#) to set up your DICOM connections and the Sonosite Synchronicity Workflow Manager User Guide to set up the remote worksheets server.

You can also connect to Telexy Qpath using Qview. Qview is a web browser application that securely provides access to Qpath worksheets. A network connection is required.

To use a custom worksheet, see [Custom worksheets \[125\]](#).



NOTE

- Downloading remote worksheets from the server replaces the local versions of the worksheets on the system.
- For the remote worksheet feature to work with static IP configurations, the network needs to be configured with a DNS address.

Configuring access to the Sonosite Synchronicity remote worksheets server

1. Set up a local DICOM location on your ultrasound system, and set **Transfer images** to **End of exam** (see [Location configuration fields \[45\]](#)).
2. On your system, set up the server as a DICOM archiver, and select the **Include private tags** check box (see [Archiver configuration fields \[47\]](#)).
3. Set the server as a secure HTTPS address. You cannot use an unsecured address.
 - a. Log into the administrative settings page.
 - b. Tap **Remote Worksheets**.
The remote worksheets page appears.
 - c. Enter the address (URL) of the remote server.
 - d. Tap **Verify** to verify the address, or **Clear** to clear the field.

Importing remote worksheets

1. Using your administrative login information, log into the administrative settings page.
2. Tap **Remote Worksheets**.
The remote worksheets page appears.
3. Tap **Synchronize** to download the remote worksheets.



NOTE

- Successfully synchronizing remote worksheets will completely replace the current set of remote worksheets.
- Tap **Verify** to test the server connection and settings.

4. Tap **OK** once the update is complete.

Configuring access to Qpath



NOTE

At least one image, video clip, or report from the study must be archived to Qpath before accessing Qview.

1. Log into the administrative settings page, and tap **Qpath**.
2. Select **Enable Qview workflow**.
3. From the drop-down menu, choose where you want the **Qpath** button to appear:
 - Patient list: Choose this option if you want users to send worksheet data only after the worksheet data has been completed and the exam has been ended. This allows data to be archived before users access Qview.
 - Patient list and worksheet: Choose this setting if you want to give users the option of accessing Qview from the worksheet page while the study is still active. You must set **Transfer images** in your DICOM settings to **During the exam**.
4. Enter the address (URL) of the remote server.
5. If you would like to verify the address, tap **Verify**.
6. If you would like to set up a Qview user, enter the Qview user name and password and tap **Verify credentials**.
7. Tap **Save** to save the settings.

Remote software updates and system monitoring

Administrators can configure and connect the system to a cloud service that allows remote software updates and system monitoring. You can download updates from the cloud and install them directly on the system or upload system logs to the cloud that allow remote service personnel to troubleshoot issues. An internet connection is required and your network firewall must be configured to allow HTTPS connection on TCP port 443 to the following URLs:

- <https://system-portal.sonosite.com>
- <http://crl.microsoft.com>
- <https://system-portal-nosni.sonosite.com>
- <https://ffss.sac.keyscaler.io/>
- <http://www.microsoft.com/pkiops/crl>
- <https://sonositesystemportal.blob.core.windows.net>

Once the system is configured and connected to the cloud, the system notifies you of any available software updates or connection errors. The notifications appear in various places including the system menu, next to **Administration** and **System Information** in the system settings list, and on the administration settings page. You can also enable non-administrative users to download and install updates.

To download and install available software updates, see [Installing software updates \[57\]](#).

Configuring the System Portal connection

1. Using your administrative login information, log into the administrative settings page.
2. Tap **System Portal Connection**.
3. On the next page, tap **Configure**.
4. On the configuration page, select the check box to enable connection to the feature.



NOTE

If the System Portal has been enabled when the system was first configured, this check box should already be selected.

5. If the system is not yet connected to a network, follow one of the procedures in [Connecting to the network \[44\]](#).
6. To use a proxy connection, select the check box and enter the proxy server information in the provided fields. Server address and port number are required.
This information is maintained if the proxy connection is turned off.
7. Tap **Save** to save the proxy settings and verify the connection. Tapping **Reset** will reset all of the fields to the last time they were saved.



NOTE

Performing a factory reset on your system will automatically disassociate the device from the System Portal.

Certificates

If your security scheme requires it, you can import and install certificates, including wireless certificates. The system supports the following file types: PFX, DER, CER, PEM, CRT, KEY, and PVK. Certain file types require a password before you can import or install them.

To connect a USB storage device, see [Inserting and removing USB devices \[19\]](#).

Managing certificates

1. Using your administrative login information, log into the administrative settings page.
2. Tap **Certificates**.
3. Do any of the following:
 - Import certificate files: Connect the USB storage device that contains the certificates. Verify that the certificates on the system, plus those on the USB storage device, do not exceed 20. Delete certificates if necessary, then tap **Import**.



NOTE

The system informs you if a certificate on the USB storage device matches an already existing certificate.

- Install certificates: Tap **Install** and select where you want the certificate to be installed (PFX certificates are installed automatically).

- Review certificate properties: Select the certificate whose properties you want to review (if reviewing a .pfx, select the specific certificate within the package from the **Certificate** list), and then tap the property of interest in **Field** to review its details.
- Delete certificate files or uninstall certificates: Select the certificate file or certificate, and then tap **Delete** or **Uninstall**.



NOTE

The system informs you if the certificate or certificate file is part of an active DICOM or wireless connection. Uninstalling or deleting the certificate would disrupt the connection.

Reviewing and resetting system settings

You can review system settings and compare them against the default factory settings. You can also reset the system to the default settings, but this will erase all settings and data.

Reviewing system settings

1. Using your administrative login information, log into the administrative settings page.
2. Tap **Admin Settings**.
3. Tap **Compare Security Controls**.

The system generates a report to compare current settings to the factory defaults. When completed, the system will give you the option to save the report to a USB drive.

Resetting the system

If you have forgotten your login information and need to reset the system, see [Returning to factory defaults \[30\]](#).



CAUTION

Restoring the system to the default settings will delete all settings and patient data. Back up your data prior to performing this action.

1. Using your administrative login information, log into the administrative settings page.
2. Tap **Admin Settings**, and then **Factory Reset**.
3. Make sure that the system is connected to AC power, then tap **Yes** to continue. Resetting the system takes approximately 35 minutes.
4. When the reset is complete, tap **OK** to restart the system.

Logging in and out

If a user login is required, the user login screen appears when you turn on the system. If your administrator has set up a server-based login, use your server user name and password to log into the ultrasound system. You can also use your server-based login if the ultrasound system is not connected to the server, provided you have already logged in at least once prior to taking the system offline. The system stores locally cached user information.

Guests can scan, save images and clips, view worksheets, and manage patient data for the current study. Guests can also access system information, on-board help, and educational videos. Guests cannot access other patient information or system settings.

Logging in and out as a user

1. On the login page, type your login name and password.
If another user is logged in, tap  at the top of the page to sign out then sign back in. You might need to end a study (see [Ending the previous study \[61\]](#)).
2. Tap **OK**.
You are also signed out if you turn off or restart the system.

Logging in as a guest

1. Turn on the system.
2. On the login page, tap **Guest**.

Changing your password



NOTE

- You can only change your password on the system if your system is using local user accounts. Server-based passwords need to be changed on the server.
- The system notifies you if your password does not meet the password requirements.
- You may need to wait to change your password. The default minimum duration between password changes is 24 minutes.

1. Turn on the system and sign into your account.
2. Tap  at the top of the page, and tap **Change Password** from the menu.
3. Type your old and new passwords, confirm the new password, and then tap **Change Password**.

Audio settings

On the audio settings page, you can specify sound settings and adjust the volume for beeps and clicks.

Displaying the audio settings page

1. Tap the system menu , and then tap **System Settings**.
2. Tap **Audio** in the list on the left.

Adjusting audio settings

On the audio settings page, do any of the following:

- Select **Button clicks** clicks for keys to click when tapped.
- Select **Beep alert** for the system to play sounds.
- Drag the **Beeps and clicks volume** slider to adjust the volume level.
To mute the volume, tap the volume control. Tap again to unmute.

Connectivity and DICOM settings

From the connectivity settings page, you can configure network and DICOM connections and import and export connectivity settings. If the system is in secure mode, only administrators can edit, import, or export connectivity settings. Other users are still able to select an active profile from the connectivity settings page.

Displaying the connectivity settings page

1. Tap the system menu , and then tap **System Settings**.
2. Tap **Connectivity** in the list on the left.

Specifying the system location

The location you specify in connectivity settings represents the active location of the system.

On the connectivity settings page, select a location from the **Location** list.

About DICOM

The ultrasound system conforms to the DICOM standard as specified in the Sonosite ST DICOM Conformance Statement, available at www.sonosite.com. The conformance statement provides information about the purpose, characteristics, configuration, and specifications of the network connections supported by the system. Using data in the Digital Imaging and Communications in Medicine (DICOM) standard, the ultrasound system can do the following:

- Transfer patient exam data to an archiver, (see [Archiving studies \[122\]](#)), such as a Picture Archive and Communication Systems (PACS) archiver.
- Confirm successful archiving with a storage commitment server.
- Import scheduled procedures and patient data from a worklist server (see [Using the worklist \[64\]](#)).
- Send status information about a performed procedure to an MPPS (modality performed procedure step) server.
- Export exam data as DICOMDIR files to a USB drive (see [Exporting studies \[124\]](#)).

The system can transfer to one or more devices and connect to different networks, depending on how you configure it. The DICOM log collects network errors and events, typically to support diagnostics (see [Logs \[59\]](#)).

Configuring the system for DICOM transfer

To configure the system for DICOM transfer, you do the following tasks (typically completed by a network administrator or PACS administrator):

1. Back up default DICOM configuration settings to a USB storage device that is kept in a secure location. You can use it to revert to the default settings if necessary (see [Importing and exporting connectivity settings \[50\]](#)).
2. Connect to the network (see [Connecting to the network by Ethernet \[44\]](#) or [Connecting to the network wirelessly \[44\]](#)).

3. Complete the DICOM configuration pages for locations and devices (see [DICOM configuration pages \[44\]](#)).
4. Associate devices with locations (see [Associating devices with locations \[49\]](#)).

Displaying the DICOM settings page

1. Tap the system menu , and then tap **System Settings**.
2. Tap **Connectivity** in the list on the left.
3. On the connectivity settings page, tap **DICOM Setup**.

Connecting to the network

You can connect to the network by Ethernet or wirelessly. Connect the ultrasound system to a standard Ethernet 10/100/1000 network. Devices connected to the stand's Ethernet port must comply with the IEC 60601-1 or IEC 60950 standards. Wireless connectivity is a licensed feature.

Connecting to the network by Ethernet

1. Connect the Ethernet cable to the Ethernet port on the back of the stand.
2. On the DICOM settings page, tap **Config** then select **Location**.
3. On the DICOM location page, tap **New** to configure a new connection.
4. See [Location configuration fields \[45\]](#) to configure and save a location with the correct network settings, making sure to select **LAN** from the **Network** type.

If the system is physically connected to a network, the Ethernet connected icon  appears in the system status area on the monitor.

Connecting to the network wirelessly

1. On the DICOM settings page, tap **Config** then select **Location**.
2. On the DICOM location page, tap **New** to configure a new connection.
3. Select wireless from the **Network** type.
4. See [Location configuration fields \[45\]](#) and [Wireless profile configuration fields \[46\]](#) to configure and save a location with the correct network settings.

The wireless icon  indicates the status of the wireless connection (the number of bars indicates the strength of the connection).

DICOM configuration pages

The DICOM configuration pages are as follows:

- **Location** Configuration for network settings, including settings for a wireless network connection. Also specifies which devices you want to associate with that network. For example, configure a location called "Office," and then associate an archiver with it. You can configure up to seven locations (see [Associating devices with locations \[49\]](#)).
- **Archive** Configuration for PACS archivers, devices for storing patient exams (images and clips). Only one archiver per location can receive in-progress image transfers, but you can select multiple archivers when ending the exam. You can associate up to four archivers per location.
- **Storage commit** Configuration for storage commitment servers, devices that take responsibility for and provide receipt of content sent by the ultrasound system.

- **Worklist** Configuration for worklist servers, devices that contain scheduled patient procedure data. You can import the data into the patient form (see [Using the worklist \[64\]](#)).
- **MPPS** Configuration for MPPS servers, devices that coordinate detailed information about the exam performed. You can associate one MPPS server per location.

Configuring a new location or device



NOTE

Changing the configuration requires a system restart.

1. On the DICOM settings page, tap **Config**.
2. On the DICOM configuration page, select a device to configure.
3. Tap **New**.
4. Complete the configuration setup fields, and tap **Save**.

Editing a location or device

1. On the appropriate configuration page, select the name from the list of locations or devices.
2. Make the desired changes.
3. Tap **Save**.

Deleting a location or device

1. On the proper configuration page, select the name from the list of locations or devices.
2. Tap **Delete**.
3. Tap **Yes** to confirm the deletion.

Location configuration fields

Alias Name that identifies the network location of the ultrasound system.

AE Title DICOM Application Entity title.

Port Device listening port number for incoming Verify requests and Storage Commit responses. TCP port 104 is typically assigned for DICOM.

IPv4 and **IPv6** Select each and fill out the following fields:

- **DCHP** or **Automatically obtain IPv6 address** Automatically obtains information for the rest of the fields.
- **IP address** Unique identifier of the ultrasound system location. Cannot be between 127.0.0.0 and 127.0.0.8.
- **Subnet mask** or **Subnet prefix length** Identifies a network subdivision.
- **Default gateway** IP address where the network connects to another network. Cannot be between 127.0.0.0 and 127.0.0.8.
- **DNS address** Domain Name Server address.

Transfer images Specify when to transfer images: during or at end of exam.

Retry delay If connectivity issues occur while transferring exam data to a DICOM server, the system pauses the transfer. From the drop-down menu, select the amount of time the system delays before retrying the transfer.

JPEG compression Select High, Medium, or Low. A high compression has a smaller file size but less detail. For best image quality, select Low.

Prevent archive time-out Select the check box to prevent a time-out when transferring data to a DICOM server.

Network Choose a network type from the list.

FIPS Select if configuring a FIPS (Federal Information Processing Standards) wireless connection.



NOTE

Selecting FIPS restricts the available security policy choice on the wireless page to WPA2, the encryption choice to AES, and the Enterprise authentication type to EAP-TLS or EAP-PEAPv0. Personal authentication (also called pre-shared key or PSK authentication) using WPA2 and AES encryption is also allowed. FIPS cannot be enabled if any of the wireless profiles associated with a location are not configured appropriately.

Wireless Profile Select if configuring a wireless location.

Wireless profile configuration fields

Profile name Name of the profile set for this location. For each wireless location, you can have up to 10 profiles.

Network name (SSID) Network Name Service Set Identifier for the network.

Connect to Hidden Networks Check the box to connect to a hidden network. By default, the box is unchecked.

Security policy Security type that authenticates the network:

- **Open** No security.
- **WPA** or **WPA2** Wi-Fi Protected Access. The following fields appear:
 - **Authentication**
 - **Personal** The **Password** field appears; enter the WPA shared key entry used in configuring the network.
 - **Enterprise** The **Authentication type** field appears; choose between EAP TLS or EAP PEAPv0 and fill out the fields:
 - **EAP TLS** Extensible Authentication Protocol-Transport Layer Security. The following fields appear:
 - **User name** Name of designated user.
 - **Client certificate** Select from the list of client certificates installed on the system.
 - **Certification authority** Validates the authentication server or certificate authority. The list is populated by imported wireless certificates (see [Certificates \[40\]](#)). Select the desired certificate from the list.

- **Encryption** Encryption protocol for the network.
- **EAP PEAPv0**
 - **User name**
 - **Password** A unique combination of letters and symbols that allows user access.
 - **Certification authority** Select the desired certificate from the list.
- **Encryption** Encryption protocol for the network.
- **RADIUS** Remote Access Dial-Up User Service -802.1x Key Exchange. The following fields appear:
 - **Authentication type** Select between EAP TLS and EAP PEAPv0, and fill out the fields as previously described.

Archiver configuration fields

Alias Unique name for the archiver.

AE Title Archiver DICOM Application Entity title.

Images Defines how images are sent to the archiver: RGB (uncompressed), Mono (uncompressed), or JPEG.

IPv4 or IPv6 Select one and fill out the **IP address**.

Use TLS Select this check box to use Transport Layer Security (TLS) protocol when transmitting data to the archiver. The following optional fields appear:

- **Client certificate** Select from the list of client certificates installed on the system.
- **Private key** One of a pair of keys (public and private) that is provided only to the requestor and never shared.
- **Private key password** The password that unlocks the private key.
- **Certification authority** Select the CA certificate used to validate the server's computer certificate from the list of imported wireless certificates (see [Certificates \[40\]](#)).

Port Archive server port number. TCP port 104 is typically assigned for DICOM.

Ping Tap to determine whether the IP address is accessible. The system displays OK or Failed.

Include video clips If the check box is selected, video clips are transferred.

Include basic text SR Select this check box to send the Basic Text Structured Report to the archiver.

Include comp SR Select this check box to send the Comprehensive Structured Report to the archiver.

Include private tags If the archiver is a Sonosite software product (for example, Sonosite Synchronicity Workflow Manager), select this check box to integrate successfully with the product.



NOTE

Because the tags may be incompatible with some earlier archivers, keep this check box unselected unless you use Sonosite software products. For more information, see the conformance statement for your ultrasound system.

Storage commit configuration fields

Alias Unique name for the storage commit server.

AE Title Storage commit DICOM Application Entity title.

IPv4 or IPv6 Select one and fill out the **IP address**.

Use TLS Select this check box to use Transport Layer Security (TLS) protocol when transmitting data to the storage commit server. The authentication fields are described in Archiver configuration fields [Archiver configuration fields \[47\]](#) and are optional.

Port Storage commit server port number. TCP port 104 is typically assigned for DICOM

Ping Tap to determine whether the IP address is accessible. The system displays OK or Failed.

Worklist configuration fields

Alias Unique name for the worklist server.

AE Title Worklist DICOM Application Entity title

Worklist (Date range) Restricts the query to patient procedures that are scheduled for: Today; Yesterday, Today, Tomorrow; All.

Study Description Mapping Select one of the options from the menu to customize which DICOM worklist tag you want to use for your Study Description.

This device only Restricts the query to patient procedures that are scheduled for the system based on its AE title.

Modality US (Ultrasound) is the default modality type.

IPv4 or IPv6 Select one and fill out the **IP address**.

Use TLS Select this check box to use Transport Layer Security (TLS) protocol when transmitting data to the worklist server. The authentication fields are described in Archiver configuration fields [Archiver configuration fields \[47\]](#) and are optional.

Port Worklist server port number. TCP port 104 is typically assigned for DICOM.

Automatic query Turns automatic query on/off.

Occurs every In an automatic query, length of time between automatic updates.

Start time In an automatic query, start time for the automatic update (displayed in 24 hour time).

Ping Tap to determine whether the IP address is accessible. The system displays OK or Failed.

MPPS configuration fields

Alias Unique name for the MPPS server.

AE Title MPPS DICOM Application Entity title.

IPv4 or IPv6 Select one and fill out the **IP address**.

Use TLS Select this check box to use Transport Layer Security (TLS) protocol when transmitting data to the MPPS server. The authentication fields are described in Archiver configuration fields [Archiver configuration fields \[47\]](#) and are optional.

Port MPPS server port number. TCP port 104 is typically assigned for DICOM.

Ping Tap to determine whether the IP address is accessible. The system displays OK or Failed.

Associating devices with locations

For each location, select which devices you want to receive the data that you transfer, which archivers you want to designate as an MPPS or storage commitment server, which worklist server you want to receive data from, and which archivers you want to set as default. Once these selections are complete, select the location you want to use.



NOTE

Changing the configuration requires a system restart.

The devices must be configured before you can associate them. See [Configuring a new location or device \[45\]](#).

1. On the DICOM settings page, select the location of the system from the **Location** list.
2. In the list of devices, check the box next to one or more archivers or worklist servers. You can select a maximum of four archivers and one worklist server for each location. Only one archiver can be selected to receive in-progress transfers. Selected devices have an adjacent check mark.
3. If you want to use the MPPS service, associate the MPPS server with the archiver:
 - a. Check the box of the MPPS server that you want. (MPPS servers appear near the end of the list.)
 - b. Check the box of the archiver.
 - c. Check the box in the archiver's MPPS column.
4. If you want to use the storage commitment service, associate the storage commitment server with the archiver:
 - a. Check the box for the storage commitment server that you want. (Storage commitment servers appear at the end of the list.)
 - b. Check the box for the archiver.
 - c. Check the box in the archiver's SC column.
5. If you want an ended study to automatically archive to an archiver, check the default box for the archiver.
There are up to four default archivers for end of exam transfers.
6. Complete any additional configuration tasks, and then tap **Done**.

Disassociating devices with a location

1. On the DICOM settings page, select the location from the **Location** list.
2. Do any of the following:
 - To disassociate an archiver or worklist server, select its check box.

- To disassociate an MPPS server from an archiver, select the check box for the MPPS server.
- To disassociate a storage commitment server from an archiver, select the check box for the storage commitment server.
- To disassociate an archiver from all servers, deselect and then reselect its check box.

Verifying the connection status of devices

On the DICOM settings page, tap **Verify** to confirm that the associated devices are connected. (If **Verify** is unavailable, check cable and wireless connections. Restart the system if you changed configuration. If the problem continues, see your system administrator.)

The connection status of the devices appears in the **Status** column:

- **Failed** DICOM cannot communicate with the device.
- **Success** DICOM can communicate with the device.
- **Unknown** Configuration may have changed since the connections were last verified.
- **Busy** The DICOM manager may be working on another task such as study data being transferred to an archiver. Wait for the transfer to complete and then tap **Verify** again.

Importing and exporting connectivity settings

You can import and export all location and connectivity settings from and to another Sonosite ST system. These settings include DICOM configuration data for locations, wireless settings, archivers, storage commit servers, worklist servers, and MPPS servers. If you have imported data, all configurations on the system are replaced with imported data. If you have exported data, all configurations on the USB storage device are replaced with exported data. If the system is in secure mode, only administrators can export connectivity settings.

The system does not import IP addresses or AE titles when you import configuration data from another system.

1. Connect the USB storage device that contains the settings (see [Inserting and removing USB devices \[19\]](#)).
2. On the DICOM settings page, tap **Config**.
3. Tap **Import** or **Export** at the bottom of the page.
4. Select the USB storage device, and then tap **Import** or **Export**.

Customization settings

On the customization settings page, you can create customized exam types and text label packages, specify settings for obstetric, vascular and abdominal measurements and calculations.

Displaying the customization settings page

1. Tap , and then tap **System Settings**.
2. Tap **Customization** in the list on the left.

Obstetrics calculations settings

See [Obstetrical references \[144\]](#).

Table 15. OB calculation authors

Calculation result	Gestational OB measurements	Available authors
Gestational Age (GA)	GS	Nyberg, Hansmann
	CRL	ASUM
		Hadlock
		Intergrowth21
	BPD	ASUM
		Hadlock
	HC	ASUM
		Hadlock
AC	ASUM	
	Hadlock	
FL	ASUM	
	Hadlock	
	OFD	Hansmann
Estimated Fetal Weight (EFW) ^a	HC, AC, FL	Hadlock 1
	BPD, AC, FL	Hadlock 2
	AC, FL	Hadlock3
	EFW%	EFW, GA

^aThe Estimated Fetal Weight (EFW) calculation uses an equation that consists of one or more fetal biometry measurements. Individual selections for Hadlock's EFW equations 1, 2, and 3 are not determined by the user. The selected equation is determined by the measurements that have been saved to the patient report with priority given to the order listed above.

Selecting authors for obstetrical calculations

1. On the customization settings page, tap **Authors** in the list on the left.
2. Select the desired authors from the drop-down lists.
3. To reset to the factory default, tap **Cancel**.

Abdominal calculations settings

1. On the customization settings page, tap **Authors**.
2. Select the desired coefficient from the drop-down list under **Bladder**.
The system will use the chosen coefficient to calculate bladder volume.

CVR calculations settings

1. On the customization settings page, tap **Authors**.
2. Select the desired author from the drop-down list under CVR (catheter to vessel ratio).

The system will calculate the vessel and catheter size as a diameter or area depending on the chosen formula.

Customizing exam types

The system displays both factory and customized exam types, organized by transducer.

You can reorder the exam types in the transducer and exam list or create a new exam type by customizing an existing exam type to use your favorite settings. When you select the new exam type the system automatically uses the settings you specified. You can also rename, delete, export and import customized exam types.

You can also create or modify a customized exam type directly from the custom exams page, but you cannot adjust the imaging controls on the page.

Creating or modifying a customized exam type

1. Select a transducer and exam type (see [Selecting a transducer and exam type \[26\]](#)).
2. Adjust imaging controls to your favorite settings (see [2D imaging controls \[69\]](#), [M Mode imaging controls \[71\]](#), [Doppler imaging controls \[73\]](#), and [Color imaging controls \[75\]](#)).
3. To adjust the position of the imaging controls on the touchscreen, see [Accessing and moving touch controls \[68\]](#).
4. Tap the system menu , then tap **Save Custom Exam**.
5. If you have initially selected an already existing customized exam type, select between updating the existing custom exam or creating a new custom exam.
6. For a new custom exam type, type a unique name of up to 40 characters.
7. Do any of the following:
 - To include changes to control settings, tap the check box.
 - To include changes to the control layout, tap the check box.
 - To change the labeling package associated with the exam type, select a package from the drop-down menu.
 - To change the order of the exam type in the list, tap it and then tap the up or down arrowheads.
8. Tap **Save Custom Exam** .

Modifying a customized exam type on the settings page

1. On the customization settings page, tap **Exam Types**.
2. On the custom exams page, select a transducer from the drop-down menu.
3. To change the labeling package associated with the exam type, select a package from the drop-down menu.
4. To change the order of an exam type in the list, tap it and then tap **Move up** or **Move down**.

Customizing text labels

You can create, edit, delete, and import and export customized labels and packages. You can modify predefined packages and save them as new packages to improve your workflow. Only text labels, not pictographs, can be modified.

Creating or modifying a custom label package

1. On the customization settings page, tap **Labels**.
2. Select a factory base package or existing custom package and then tap **Edit**. Alternatively, double tap the package.



NOTE

Custom label packages include an asterisk * as the first character in the name.

3. On the next page, do one of the following:
 - Tap an empty label position in the package and create a new label using the on-screen keyboard.
 - Tap an existing label and edit it using the on-screen keyboard.
 - Delete a label.
4. Do one of the following:
 - Save the package as a new custom package.
 - Replace the package by updating the package name. You cannot update factory base packages.
5. Tap **Save**.

Deleting a custom label package

1. On the customization settings page, tap **Labels**.
2. Select the custom label package you want to delete.
3. Tap **Delete**.

Importing or exporting customized settings



NOTE

- Only administrators can import and export customized settings if the system is in secure mode.
- You can also export customized settings on the general settings page and import them to a new system using the configuration wizard.



NOTE

Before you begin, observe the following:

- If you are importing customized settings, make sure you are in a factory base exam type.
- If the system is in secure mode, log in as an administrator.
- Enable USB devices and export in the Administration settings (administrators only).

1. Connect a USB storage device (see [Inserting and removing USB devices \[19\]](#)).
2. On the customization settings page, do either of the following:
 - To import customized settings, tap **Import** and then **Yes**. Select the desired USB storage device, and tap **Import** again.

Customized settings are replaced with those from the USB storage device.

- To export customized settings, tap **Export** and then **Yes**. Select the desired USB storage device, and tap **Export** again.

A copy saves to your USB storage device.

Date and time settings



WARNING

To obtain accurate obstetrics calculations, an accurate date and time are critical. Verify that the date and time are accurate before each use of the system.

Displaying the date and time settings page

1. Tap , and then tap **System Settings**.
2. Tap **Date and Time** in the list on the left.

Setting the date and time

On the date and time settings page, do the following:

- Choose the desired date format, and then type the current year, month, and day.
- Type the current time in hours and minutes.
- To obtain the system time from a time server, select **Use time on time server** and enter the **Server address**.



NOTE

If you select **Use time on time server**, you cannot manually edit the date and time.

- To specify that the system automatically adjusts for daylight savings time changes, select **Daylight savings time**.
- Select your time zone from the **Time zone** list.

Display information settings

On the display information settings page, you can specify which details appear on the monitor during imaging.

Displaying the display information settings page

1. Tap the system menu , and then tap **System Settings**.
2. Tap **Display Information** in the list on the left.

Specifying details that appear on the monitor

On the display information settings page, select settings in the following sections:

- **Patient header** Information that appears in the patient header including the patient name, ID, department ID, date, time, user, and institution.
- **Mode data** Imaging information for 2D, Doppler, Color, or M Mode.

Network status

The network status page displays the following information:

General information

- Location
- IP connectivity and addresses (both IPv4 and IPv6)
- Subnet mask
- Default gateway
- DNS address
- Ethernet MAC address

Wireless only information

- Wireless network SSID
- Connected BSSID
- Wireless MAC address
- Wireless signal strength
- Wireless connection status
- FIPS status

Displaying the network status page

1. Tap the system menu , and then tap **System Settings**.
2. Tap **Network Status** in the list on the left.

Power and battery settings

On the power and battery settings page, you can specify the period of inactivity before the system goes into sleep mode or turns off. The power and battery settings page also displays battery status including how long the system can scan on battery power alone.

Displaying the power and battery settings page

1. Tap , and then tap **System Settings**.
2. Tap **Power and Battery** in the list on the left.

Specifying power settings

On the power and battery settings page, select from the following:

- **Sleep delay (min)**: Select **Off**, **5**, **10**, **20**, or **30** minutes to specify the period of inactivity before the system goes into sleep mode. You can select a different setting for when the system is plugged in or on battery power. The system automatically turns off if it is in sleep mode and the battery charge level drops below 14%.



NOTE

The system will not sleep if you are in Procedure mode (see [2D imaging controls \[69\]](#)).

- **Power delay (min)** : Select **Off**, **15**, **30**, **45**, or **60** minutes to specify the period of inactivity before the system automatically turns off. You can select a different setting for when the system is plugged in or on battery power.
- **Performance mode** or **Efficiency mode**: Performance mode allows the system to start up in 20 seconds instead of 45 seconds after powering off, but this mode uses more power. By default, the system is in performance mode when it is plugged in. When using the battery, the system lasts longer in efficiency mode, with about four days of charge when asleep, compared to seven hours in performance mode. If the battery-powered system is in performance mode and has about 15 minutes of imaging time left, it switches to efficiency mode.

General settings

The general settings page has settings for general presets and the ability to export some system settings.

Displaying the general settings page

1. Tap the system menu , and then tap **System Settings**.
2. Tap **General** in the list on the left.

Adjusting brightness

On the general settings page, drag the **Monitor brightness** slider right or left.

Selecting patient ID settings

Under **Patient ID**, do any of the following:

- **Auto save patient form** When this option is on, the system saves the patient form as an image in the patient's study.
- **Generate patient ID** When this option is on, the system automatically generates a unique patient ID upon starting a study from the patient form, unless a patient ID is entered manually or from the worklist. This option can be used to accommodate certain workflows. You can optionally enter any characters as the start of the ID into the **Prefix** field.

Choosing a startup mode

You can choose what mode the system will be in when you start it, end a study, or log in.

On the general settings page, select an option in the **Startup** section:

- **Start select screen** Displays the startup screen, which offers you the option of scanning, entering patient information, selecting a transducer and exam type, or viewing visual guides.
- **Scanning** Displays the 2D imaging screen.
- **Transducer/exam select** Displays the options for selecting transducers and exam types.
- **Patient info** Displays the patient form.

Automatically querying the worklist with a barcode scanner



WARNING

Before using the barcode scanner with patients, verify that any custom programming is working as expected.

You can specify that the system query the worklist for patient information when you scan a patient ID barcode.

On the general settings page, select **Barcode Auto Query**.

Exporting system settings

Some system settings, including user accounts, general preferences, and customized exam types, can be exported from the General settings page. Exported settings can be imported to another Sonosite ST system, or to the same system if a factory reset has occurred. When you export from the general settings page, all system settings on the USB storage device are replaced with the exported settings. If the system is in secure mode, only administrators can export system settings.

1. Connect a USB storage device (see [Inserting and removing USB devices \[19\]](#)).
2. On the general settings page, tap **Export** and then tap **Yes**.
3. Select the desired USB storage device, and then tap **Export**.

System information

The system information page displays system hardware and software versions, patents, and license information. If the system has been configured by an administrator, you can also check for and install any available software updates. If any updates are available, downloading, or installing, a notification appears next to **System Settings** in the system menu and **System Information** in the system settings list.

See also [Software licensing \[152\]](#) and [Configuring the System Portal connection \[40\]](#).

Displaying the system information page

1. Tap the system menu , and then tap **System Settings**.
2. Tap **System Information** in the list on the left.

Installing software updates

Administrative users can also perform the following procedure on the System Portal page, which is available from the Administration page. The system needs to be connected to the Internet, System Portal, and to AC power.

1. On the system information page, tap **Check Update**.
The system checks for an available software update.
2. Tap **Download**. The system begins downloading the update.
You can pause or cancel the download or continue using the system during the download process.

3. Monitor the download by checking the status on the page.
4. When the download is complete, verify that the system is ready for an update by making sure it is connected to a power supply and ending any exams.
5. Tap **Install**.

USB settings

On the USB settings page, you can view information about connected USB devices, specify file formats and options for exporting data to a USB storage device.



NOTE

You can only export data to a USB storage device if your administrator has enabled this setting.

Displaying the USB settings page

1. Tap the system menu , and then tap **System Settings**.
2. Tap **USB** in the list on the left.

Specifying USB export options

1. On the USB settings page, select an **Export type**.
 - **DICOM export** creates DICOMDIR files readable by a DICOM reader. Video clips export in MJPEG format.
 - **Multimedia export** organizes files in a standard folder structure. Video clips export as mp4 files.
2. Select an image format for your export type. For JPEG formats, also select a JPEG compression. A high compression has a smaller file size but less detail (see [Limitations of JPEG format \[58\]](#)).
For optimal DICOM image quality, select RGB image format and low compression.
3. (Multimedia export only) Select a sort order from the **Sort by** list.
4. (DICOM export only) Select any of the following:
 - **Include basic text SR** to export the Basic Text Structured Report.
 - **Include comp SR** to export the Comprehensive Structured Report.

Limitations of JPEG format

When transferring or exporting images in JPEG format, the system uses lossy compression. Lossy compression may create images that have less absolute detail than BMP format and do not render identically to the original images. In some circumstances, lossy-compressed images may be inappropriate for clinical use.

Table 16. JPEG compression settings

Setting	Quality level
Low	100%; The difference between the compressed and uncompressed image is near 0.

Setting	Quality level
Medium	90%; Generally loss only to high frequency content (some degradation occurs at the edges of structures in the image).
High	75%; General loss of detail.



NOTE

The ratio of the image size without compression to the image size with compression is dependent on the content of the image.

For more information on using lossy-compressed images, consult the industry literature.

Logs

Logs collect information that may be useful when troubleshooting the system. You can send the information to FUJIFILM Sonosite Technical Support (see [Getting help \[2\]](#)).

You can export the logs as .csv files to a USB storage device and read them on a PC using a spreadsheet program. Log contents are saved as entries are generated. The logs have limited space and overwrite existing content when full. Only an administrator can clear logs.

On the logs settings page, you can view the following logs:

- **All** Displays all the following types of logs.
- **User** Collects information about user logins and user creation, as well as information about when the log was exported or cleared.
- **DICOM** Collects network errors and events, typically to support diagnostics.
- **Assert** Collects information about system exceptions and major error events to support diagnostics.
- **System** Collects information on both normal and abnormal system behavior, as well as transducer and system diagnostic details.
- **Diagnostics** Records the results of the diagnostic check of transducer imaging elements that the system performs automatically when a transducer is initially activated. This report log identifies any transducer element that might be experiencing poor performance. [Figure 4, "Transducer diagnostic report" \[59\]](#) displays an example of a diagnostic report.

Figure 4. Transducer diagnostic report

Transducer performance test detected suspicious elements (element numbers go from 0 to 127): 6, 7, 8, 11, 13, 15.

Suspicious elements per image region: left 6, center 0, right 0.

Configuration: System SN: 000PHX. Software BOM: 1.0.00012. TTC SN: 123456. Transducer: L19-5 with SN 123456 in bay 2. Please see the user guide's Troubleshooting and Maintenance section for more information about addressing image quality issues.

- **ePHI** Collects information about creating, deleting, modifying, accessing, viewing, storing, and exporting patient data.



NOTE

Only administrators can access the ePHI logs.

Viewing and clearing logs

1. Tap , and then tap **System Settings**.
2. Tap **Logs** in the list on the left.
3. On the Logs page, tap the log under **Log type**.
4. Tap **Clear** and confirm your selection.

Exporting a log



CAUTION

Any logs that were previously exported to the USB storage device will be deleted. If you want to keep these files, copy them to another location before continuing.

1. Connect a USB storage device (see [Inserting and removing USB devices \[19\]](#)).
2. On the logs page, tap the log under **Log type**,
3. Tap **Export**, then tap **Yes** to confirm the export.
A list of USB storage devices appears.
4. Select the appropriate USB storage device, and tap **Export**.
5. Five seconds after the exporting completes, you can safely remove the USB storage device.

Uploading logs

The system needs to be connected to the System Portal. See [Configuring the System Portal connection \[40\]](#).

1. Using your administrative login information, log into the administrative settings page.
2. Tap **System Portal Connection**.
3. On the next page, tap **Upload logs**.

Entering Patient Information

Sonosite ST offers tools for entering, searching, and managing patient information, which will become part of the patient exam record, or study. You can search the worklist server for specific studies, update patient information, create new studies, and save exams. For more information on managing patient data and studies, see [Managing Patient Data \[121\]](#).

You can start scanning without entering any patient information. As soon as you begin collecting images and data, the data is saved to a new study and the **END STUDY** button appears.



NOTE

If you want to save images and other data to a new study, you need to end the previous study. Before archiving any images, you should enter a patient name (see [Creating a new patient \[61\]](#)).

Ending the previous study

1. Make sure that you have saved images and other information that you want to keep (see [Saving an image or a clip \[86\]](#)).
2. On the touchscreen, tap **END STUDY**.
The end study dialog box appears.
3. If configured, select or deselect one or more archivers.
Archivers that have previously been configured as default are already selected (see [Associating devices with locations \[49\]](#)).
4. Do one of the following:
 - To start a new study tap **Yes**.
The startup screen appears.
 - To return to the current study, tap **Cancel**.



NOTE

Turning off the system also ends the study.

Creating a new patient

The patient form lets you enter identification, exam, and clinical details for the patient study.

After you begin a new patient form, all images, video clips, and other information you save during the study are linked to that patient.

1. To start a new patient information form, do one of the following:
 - Tap **Enter** on the startup screen.

- Tap **+ New Patient** on the touchscreen.
- 2. Enter patient information into the text fields on the patient form.
- 3. Tap  to close the keyboard, or tap **Scan** to scan.

Patient form fields

The patient form fields available depend on exam type. In some fields, you can enter symbols and special characters.

- **Patient**
 - MRN (medical record number)
 - Patient name fields
 - Accession number
 - Date of birth



NOTE

The Generate patient ID option enables the system to auto-generate a unique patient ID to accommodate certain workflows. For more information, see [Selecting patient ID settings \[56\]](#).

- **Provider**

Tap the  to expand the menu.

 - Performing (up to three)
 - Referring
- **Institution** (tap to expand the menu)
 - Type the institution's name.
 - Department ID
- **Change Transducer/Exam**

Displays the current transducer and exam type. Tap the button to navigate to the transducer and exam select screen. An asterisk next to an exam type indicates that it is a customized exam type. Only customized exam types can be renamed or deleted.
- **More exam info** (tap to expand the menu)
 - Gender
 - Height
 - The patient height in centimeters and inches
 - Weight
 - The patient weight in kilograms and pounds
 - BMI (body mass index)
 - Automatically calculated after you enter height and weight.
 - BSA (body surface area)
 - Automatically calculated after you enter height and weight.
 - HR (heart rate)
 - Enter the beats per minute.
 - BP (blood pressure)
 - Indications
- **Obstetrics** (tap to expand the menu)

- Last menstrual period
In an obstetrical exam, select **LMP** or **EDD** and then enter either the date of the last menstrual period or the established due date. The LMP date must precede the current system date.
- Gestational age (weeks and days)
This field automatically updates after a value for the **LMP** or **EDD** field is entered.
- Gravida
Enter the total number of pregnancies.
- Multiples
Select the number of multiples (up to four) to display multiple sets of measurements on the calculations menu.
- Para
Enter the total number of births.
- Aborta
Enter the total number of abortions.
- NT Credential
A combination of letters and numbers representing a Nuchal Translucency (NT) credential ID number. For example, P12345.
- **Procedure Codes** (tap to expand the menu)
Available only if the DICOM worklist feature is configured. For further details, see [Using the worklist \[64\]](#).

Entering patient information with a barcode scanner

You can enter patient or clinician data using a custom-programmed or non-programmed barcode scanner. For more information on custom-programming, see the *Barcode Scanner Expression Supplement* and contact your customer representative. The barcode scanner can also initiate a DICOM worklist query.

You can use the barcode scanner while the system is in imaging mode, in the patient form, or in a worksheet.



WARNING

Before using the barcode scanner with patients, verify that any custom programming is working as expected.

1. Do one of the following:
 - If you are querying the worklist with the barcode scanner, select **Barcode auto query** on the general settings page before scanning the barcode.
 - If you are using a non-programmed barcode scanner and would like to enter specific data in the patient form, open a patient form and select the appropriate text field before scanning the barcode.
 - Directly scan the barcode.
2. One of the following occurs:
 - If you are querying the worklist with the barcode scanner, matching patient information appears in the worklist. Highlight the patient from the worklist, then tap **Select**.

- If you are using a non-programmed barcode scanner and have selected a text field in the patient form, data appears in the field.
 - If you are using a non-programmed barcode scanner and did not select a text field, the MRN text field auto-populates.
 - If you are using a custom-programmed barcode scanner, the system populates the patient form with the scanned information.
3. Tap **Scan**.
If you have not ended the previous study, a dialog appears.
 4. Tap **OK** to scan with the new patient information.

Using the worklist

You can import patient information from the Hospital Information System or Radiology Information System with the DICOM worklist feature.

The worklist automatically updates if set up for an automatic worklist query. You can also manually update the worklist, and you can manually search the worklist server for a matching patient procedure.

Setting up the worklist

1. Configure the system for DICOM transfer (see [Configuring the system for DICOM transfer \[43\]](#)).
2. Configure the worklist server (see [Worklist configuration fields \[48\]](#)).
3. Select the parameters used for worklist queries.
The following table displays the parameters that apply to searches and updates:

Table 17. Query parameters

Parameters	Manual patient search	Manual worklist update	Automatic query update
Patient data	✓	—	—
Date range	✓	✓	✓
Modality	✓	✓	✓
This device only	✓	✓	✓
Automatic query on/off	—	—	✓
Occurs every	—	—	✓
Start time	—	—	✓

4. Connect the worklist server to the system.

Accessing the worklist

Tap **Worklist** on the touchscreen or at the bottom of the patient form. The current list of scheduled patients appears.

Sorting the worklist

By default, the list is sorted by date and time, with the most recent patient listed first. You can re-sort the list.

Tap the column heading that you want to sort by. Tap it again to sort in reverse order.

Manually searching the worklist

1. On a new patient form, do any of the following:
 - Fill in any of the following fields for the query: MRN, patient name, and accession number. The search is on the characters you enter. For example, Smith returns *Smith, Smithson, Smithy*.
 - Under **Procedure Codes**, specify any of the following from **Additional worklist query parameters**:
 - **Modality** US (Ultrasound) is the default.
 - **Requested procedure ID** type a procedure ID.
 - Tap **Cancel** to revert changes and close the patient form.
2. Tap **Search**.
The worklist appears with the search results, number of results, and time of the last update.

Clearing the worklist

While in the worklist, tap the **Clear** button. Search results are removed.

Entering patient information from the worklist

1. In the worklist, select the patient procedure you want.



NOTE

You can select more than one procedure if the patient information matches.

2. Do one of the following:
 - Tap **Select** to import patient information into the patient form. Patient information from the worklist is uneditable.
 - To return to the patient form without selecting a procedure, tap **Cancel**.

Selecting a scheduled procedure

Once you have imported patient information from the worklist, you can select a scheduled procedure for the patient.

1. On the patient form, tap the  to expand the menu under **Procedure Codes**.
2. Under **Scheduled Procedure**, select a procedure from the **Name** list.
Only procedures imported from the worklist are visible.
3. Select a protocol from the drop-down list.
The definition of the selected procedure appears in the **Meaning** field.





Selecting the performed procedure

You can select a procedure different from the scheduled procedure.

1. On the patient form, tap the  to expand the menu under **Procedure Codes**.
2. Under **Performed Procedure**, select the desired procedure from the **Code** list.
The definition of the procedure appears in the **Meaning** field. If desired, you can edit the field.

Definitions selected here for the **Study description** fields appear on the patient form.

Modifying procedure codes

1. On the patient form, tap the  to expand the menu under **Procedure Codes**.
2. Under **Performed Procedure**, tap **Edit** to navigate to **Performed Procedure Codes**.
3. To add a new code (required fields are marked with an asterisk):
 - a. Tap **Add Code**.
 - b. Tap .
 - c. Fill in the **Code**, **Code scheme**, **Code meaning** and **Study description** fields.
 - d. Tap  **Save**.
4. To edit or delete a code, tap a row in the list and then tap  or . You can select a new description for any field from the drop-down menus.

Definitions selected here for the **Code meaning** and **Study description** fields appear on the patient form.

Saving patient information

Patient information is automatically saved and included in the study when entered in the patient form. You can configure the system to save an image of the patient form automatically. See [Selecting patient ID settings \[56\]](#).

Editing or adding patient information during an exam

Patient information cannot be edited once an exam has ended, if the exam was started from the worklist, if archiving during the exam is enabled, or if MPPS is in use. You can add patient information directly from a worklist during an ongoing exam.

Before editing or adding any patient information, including from the worklist, make sure to set **Transfer images to End of exam** (see [Location configuration fields \[45\]](#)) and disassociate any MPPS servers (see [Disassociating devices with a location \[49\]](#)).

1. To access the patient information form, tap **Patient**.
2. Do one of the following:
 - Tap a text box to edit it using the on-screen keyboard.
 - Tap **Worklist** and select the desired scheduled procedure from the worklist.
3. In the patient information form, tap **Cancel** to cancel your changes and return to scanning, or tap **Scan**.
A pop-up message appears warning you that patient data has changed.
4. Do one of the following:
 - Tap **Cancel** to cancel any edits and return to the scan.
 - Tap **Modify** to change patient data without ending the study.
 - Tap **New** to start a new study using the edited information. If you select this option, you are asked to end the previous study (see [Ending the previous study \[61\]](#)).

Reviewing patient information

You can review patient information when you review worksheets, calculations, and the report. See [Managing reports and worksheets \[125\]](#).

1. Tap **Report & Worksheet**.
The workspace displays with the default Worksheet tab open.
2. To open patient information, tap the **Patient** tab.
A read-only version of the patient form opens.
3. Review the patient information.

Scanning

This section describes scanning with the Sonosite ST ultrasound system.

Understanding imaging modes

Sonosite ST allows you to scan in several imaging modes. The modes that are available to you depend on the transducer and the exam type you have chosen.

The active imaging mode (or modes) is always highlighted in blue.

- **2D** is the system's default imaging mode. The system displays echoes in two-dimensional view by assigning a brightness level based on the echo signal amplitude.
- **M Mode** (motion mode) is a time motion display of the ultrasound wave along a chosen ultrasound line. It provides a trace of the 2D image displayed over time. A single beam of ultrasound is transmitted, and reflected signals are displayed as dots of varying intensities, creating lines across the screen.
- **Doppler** imaging is a display of a spectrum of flow velocities over time. The amplitude of the signal is indicated as a shade of gray. You can use Doppler imaging to display blood flow and tissue movement.
- **Color** is a form of pulse wave (PW) Doppler that uses color to show the presence, velocity, and direction of blood flow toward and away from the transducer.



NOTE

Doppler imaging is available as a licensed option in some countries .

Imaging controls

During scanning, a set of commonly used controls based on your imaging mode, chosen transducer, and exam type are located in the control panel on the touchscreen. Control availability depends on whether the image is live or frozen. When creating a customized exam type (see [Customizing exam types \[51\]](#)), you can adjust which controls are located in the central area of your control panel by moving controls from the **+ More Controls** area.

Accessing and moving touch controls

1. If moving controls for frozen imaging, freeze the image by tapping .
2. Tap **+ More Controls** at the bottom of the touchscreen.
The control area expands, and you can scroll down to use additional imaging controls.
3. For each control you want to move:
 - a. Press and hold down on the title bar until the control gets slightly bigger.
 - b. Drag the control to the desired position on the touchscreen and lift your finger.
The control snaps into place.
4. To close the **+ More Controls** area, tap **- Less Controls**.

Scanning in 2D

1. From another imaging mode, press the **2D** button (2D is the default scan mode).
A blue highlight appears when 2D is active.
2. Adjust the controls as needed.
3. To freeze the image, press .

2D imaging controls

Table 18. Controls available in 2D

Control	Use	Available in	
		Live	Frozen
Auto Gain Adjust	Tap the up or down arrows on the control to set the target brightness level the system uses when you use the automatic gain controls. For more information on adjusting the gain, see Adjusting the gain [77] .	✓	—
Centerline	Tap the button on the control to turn the centerline graphic on or off. You can use the graphic to align the image with the transducer. See Using the centerline [80] .	✓	—
Dual	<ol style="list-style-type: none"> 1. Tap the right or left buttons to scan the right or left images. 2. Tap the opposite button (L or R) to scan the opposite image. You can also tap the right or left images to switch between the images. <p>See Scanning in dual mode [76].</p>	✓	✓
Dynamic Range	Tap the up or down arrows to control the contrast of the gray scale used in the image. A lower setting increases the image contrast, making echoes appear brighter against a darker background.	✓	✓
Focus	Adjust the focal zone of the image while using the following transducers and exam types: <ul style="list-style-type: none"> • C5-1 Lung • P5-1 Cardiac, Focused Cardiac, Pediatric Cardiac, Lung • T8-3 Cardiac, Cardiac Resuscitation, Lung <p>Tap the arrows to adjust the focal zones up and down. The focal zone indicator  moves accordingly on the depth scale. You cannot adjust focal zones if the image is zoomed or in simultaneous mode.</p>	✓	—
LVO	Tap the button on the control to lower the mechanical index (MI) of the system. THI is also turned on. Sonosite ST is not validated or cannot support the use of contrast imaging. Only available in cardiac exam types.	✓	—
Needle Guide	<ol style="list-style-type: none"> 1. If using an IC10-3 or L19-5 transducer with an attached needle bracket, tap the control to turn the needle guide on. 2. For transverse-angle brackets, use the slider on the touchscreen to adjust depth. <p>See Needle guide control [84].</p>	✓	—
Needle Profiling	Tap the left or right button on the control to choose the needle entry side. See Needle profiling [82] .	✓	—

Control	Use	Available in	
		Live	Frozen
Optimize	<p>Tap one of the available options (the system automatically gives you a selection based on the exam type and transducer):</p> <ul style="list-style-type: none"> • Res provides the best possible resolution. Use this setting when the ultrasound signal does not need to penetrate very deeply, such as for shallow structures. • Gen balances resolution and penetration. • Pen provides the best possible penetration. Use this setting when the ultrasound signal needs to penetrate deeply. • Lung optimizes lung exams to visualize lung sliding and A/B line artifacts. • Cons/Eff optimizes lung exams to visualize pulmonary consolidation and pleural effusion. <p>The image is optimized by applying a specific group of settings such as focal zones, aperture size, frequency (center and bandwidth), line density, and waveform.</p>	✓	—
Orientation	<ol style="list-style-type: none"> 1. Tap a button on the control to orient the image to the upper right, upper left, lower left, or the lower right. 2. Make sure that the location of the dot on the icon matches up with the indicator located on the side of the transducer. 	✓	—
Power	Tap the arrows on the control to adjust the transmit power levels to the desired range while maintaining adequate image quality. MI (mechanical index) and TI (thermal index) are updated accordingly.	✓	—
Print	Tap the button to print the current screen image to a configured external printer.	✓	✓
Procedure Mode	Turn on or off by tapping the button on the control. When Procedure Mode is on, sleep mode and automatic power-off are disabled, and the system is prevented from interrupting a procedure.	✓	—
Reset Gain	Tap the button on the control to return the gain to default values. For more information on adjusting the gain, see Adjusting the gain [77] .	✓	—
RFID Shield	<p>Turn on or off by tapping the button on the control. Use this control to reduce RFID (radio-frequency identification) interference, which can interfere with the transducer signal. The control changes the transducer signal to prevent signal overlap. Be aware that this can also affect imaging quality. RFID Shield is available on the following transducers and exam types:</p> <ul style="list-style-type: none"> • L12-3 in all exam types except Lung and Ophthalmic • L13-6 in all exam types • L15-4 in all exam types 	✓	—
Sector	<ol style="list-style-type: none"> 1. Turn on or off by tapping the button on the control. 2. To steer the sector, drag it left or right on the touchscreen. To adjust the width, tap and drag the circle on the corner. 	✓	—
SonoMB	Turn on or off by tapping the button on the control. Multibeam imaging enhances the 2D image by viewing a target from multiple angles and then merging or averaging the data (not available with phased array transducers).	✓	—

Control	Use	Available in	
		Live	Frozen
Thermal Index	Tap the button on the control to select a thermal index (TI) setting: <ul style="list-style-type: none"> • TIS (soft tissue): choose this setting for soft tissues. • TIB (bone): choose this setting when the ultrasound beam passes through soft tissue and a focal region is in the immediate vicinity of bone. • TIC (cranial bone): choose this setting when the ultrasound beam passes through bone near the beam entrance into the body. 	✓	—
THI	Tap the button on the control to turn Tissue Harmonic Imaging (THI) on or off. THI allows the system to transmit at one frequency and receive at a different frequency to reduce noise and improve resolution. Dynamic range is reduced. Available with certain exam types and transducers.	✓	—
Trapezoid	Turn on or off by tapping the button on the control. Trapezoid imaging assists with the measurement and assessment of large structures that do not fit into the current field of view for both linear and curved transducers. Trapezoidal imaging extends the lateral field of view to that accessible by steering the beams. On linear arrays, this results in a trapezoid-shaped image. On curved arrays, this results in a wider azimuthal field of view. Trapezoid imaging is compatible with C10-3, C5-1, IC10-3, L13-6, L12-3, L15-4, and L19-5 transducers, and is supported on all exam types except the lung exam.	✓	—
Video Clip Settings	Tap the button on the control to display the video clip settings. See Setting clip controls [86] .	✓	—
Zoom	<ul style="list-style-type: none"> • During live imaging, tap the magnifying glass (for further details, see Zooming [78]). • When the image is frozen, tap the up or down arrows to increase or decrease the zoom. 	✓	✓

Scanning in M Mode

1. Tap **M Mode**.
The control is highlighted, and the M-line appears on the 2D image.
2. Drag the M-line on the touchscreen to move the M-line to the desired position in the 2D image.
3. To display both the live M-line image and M Mode trace, tap **M Mode** again.
4. To switch the focus between the trace and the M-line (2D image), tap the 2D image or M Mode trace on the touchscreen.
5. Adjust the images and controls with each image selected.
You can also tap **2D** or **M Mode** to change the focus between the 2D and M Mode images and controls.
6. To exit M Mode, tap **2D** or **M**.

M Mode imaging controls

In addition to most of the 2D controls, M Mode imaging uses the following controls. See [2D imaging controls \[69\]](#).

Table 19. Controls available in M Mode

Control	Use	Available in	
		Live	Frozen
Display Format	<p>Tap the button on the control to display the settings, then tap the format of your choice:</p> <ul style="list-style-type: none"> • 1/3 2D, 2/3 Sweep • 1/2 2D, 1/2 Sweep • 2/3 2D, 1/3 Sweep • Side by Side <p>For example, 1/3 2D, 2/3 Sweep divides the screen so that the top 1/3 shows the 2D image with the M- or D-line, while the bottom 2/3 displays the M Mode or Doppler trace. You can adjust the images independently of each other.</p>	✓	✓
Sweep Speed	<p>Tap Slow, Med, or Fast to select the speed of the M Mode trace. Sweep speed affects the number of heart cycles displayed. Use a slower speed for slower heart rates, and a faster speed for faster heart rates.</p>	✓	—

Scanning in Doppler



NOTE

Doppler imaging is available as a licensed option in some countries .

Your ultrasound system has several types of Doppler imaging available:

- **Pulsed Wave (PW)**; the transducer emits ultrasound pulses to a specific depth, limiting the velocities that can be measured, but allowing you to accurately determine the location of blood flow.
- **Continuous Wave (CW)**; the transducer continuously emits and receives ultrasound waves along the beam, enabling the measurement of high velocity blood flow independent of a specific depth location.
- **Pulsed Wave Tissue Doppler Imaging (TDI)**; the pulsed wave signal measures velocity of myocardial tissue movement rather than blood flow.



NOTE

CW and TDI are available only in cardiac exam types.

1. Tap **D** .
The control is highlighted, and the D-line appears on the 2D image.
2. For cardiac exam types only, select one of the following modes on the **Doppler Mode** control:
 - **PW** - Pulsed wave Doppler
 - **CW** - Continuous wave Doppler
 - **TDI** - Tissue Doppler Imaging
3. Adjust the D-line and the gate (sample volume):

- Move the D-line to the desired position in the 2D image.
 - To adjust the D-line tilt, tap a setting on the **Steering** control (linear transducers only).
 - To position the PW or TDI gate, drag it up or down on the touchscreen.
 - To adjust the gate size, tap the arrows on the **Gate** control.
 - To adjust the Doppler angle, use the **Angle Correct** control.
4. To begin Doppler scrolling, tap **D** again.
 5. To switch the selection between the scrolling image and the D-line (2D image), tap the 2D image or Doppler trace on the touchscreen.
 6. With each image selected, adjust the images and controls.
You can also tap **2D** or **Doppler** to change the focus between the 2D and Doppler images and controls.
 7. To exit Doppler, tap **2D** or **D**.

Doppler imaging controls

In Doppler imaging, you can adjust controls in D-line and in scrolling Doppler.

Table 20. Controls available in Doppler

Control	Use	Available in	
		Live	Frozen
Angle Correct	Tap a preset button, use the slider to rotate to any angle from -60° to 60° , or tap the arrows next to the slider for more precise angle adjustments.	✓	✓
Auto Trace	<ol style="list-style-type: none"> 1. Tap the button to access the auto trace settings. 2. Choose which part of the Doppler waveform to trace (peak or mean) and where to display the trace relative to the baseline. <p>The settings chosen apply to the automatic trace you can use to make Doppler measurements. See Performing automatic trace measurements [100] .</p>	✓	✓
Display Format	<p>Tap the button on the control to display the settings, then tap the format of your choice:</p> <ul style="list-style-type: none"> • 1/3 2D, 2/3 Sweep • 1/2 2D, 1/2 Sweep • 2/3 2D, 1/3 Sweep • Side by Side • Full 2D, Full Sweep <p>For example, 1/3 2D, 2/3 Sweep divides the screen so that the top 1/3 shows the 2D image with the M- or D-line, while the bottom 2/3 displays the M Mode or Doppler trace.</p>	✓	✓
Doppler Baseline	Tap the up or down arrows to move the baseline. You can also move the baseline directly on the touchscreen. Repositioning the Doppler baseline can optimize for the aliasing velocity.	✓	✓
Doppler Mode	Tap PW , CW , or TDI (CW and TDI are available only in the cardiac exam type) See Scanning in Doppler [72] for an explanation of Doppler modes.	✓	—

Control	Use	Available in	
		Live	Frozen
Doppler Scale	Changing the Doppler scale can help optimize the display for faster or slower blood flow. Tap the up or down arrows to change the maximum velocity displayed on the Doppler scale.	✓	—
Gate	Tap the up or down arrows to increase or decrease the gate size, modifying the amount of information included in the Doppler sample.	✓	—
Invert	Turn on or off by tapping the button on the control. Invert switches the direction of the Doppler spectral display.	✓	✓
Power	Tap the arrows on the control to adjust the transmit power levels to the desired range while maintaining adequate image quality. MI (mechanical index) and TI (thermal index) are updated accordingly.	✓	—
Print	Tap the button to print the current screen image to a configured external printer.	✓	✓
Simultaneous	Turn on or off by tapping the button on the control.	✓	—
Steering	Tap a setting to optimize the Doppler angle for the direction of the blood flow (linear transducers only). You can also steer the Doppler line by swiping left or right on the touchscreen.	✓	—
Sweep Speed	Tap Slow , Med , or Fast to set the speed of the Doppler trace. Sweep speed affects the number of heart cycles displayed. Use a slower speed for slower heart rates, and a faster speed for faster heart rates.	✓	—
Volume	Tap the up or down arrows to increase or decrease the Doppler speaker volume.	✓	—
Wall Filter	Tap to select the strength of the filter: Low , Med , or High . Wall Filter removes low level echoes on each side of the baseline. A higher filter correlates to a higher cutoff velocity.	✓	—

Scanning in Color

The color display is usually superimposed on the 2D image, allowing you to simultaneously visualize anatomy and flow dynamics. Your ultrasound system has several types of color imaging available:

- Color or Color Velocity Doppler (CVD) imaging provides velocity information.
- Color Power Doppler (CPD) imaging provides amplitude strength of the Doppler signal but does not provide velocity information. You can use it to detect the presence of blood flow in very low flow states.
- Variance (Var) displays a color map that highlights areas of blood flow with rapidly changing velocities by indicating high variance in green. High variance can suggest turbulent flow. Variance is available in cardiac exams only.

1. Tap the **C** button.
The control is highlighted, and the color box appears.
2. To change the type of color imaging the system uses, tap the appropriate button in the **Color Type** control.
3. Position the color box by dragging your finger on the touchscreen.
4. Size the color box by touching and moving the circle at the bottom-right corner.

5. To steer the color box (linear transducers only), tap **Steering** and select an angle. You can also steer the color box by swiping on the touchscreen.
6. Adjust controls as needed. You can also tap **2D** or **Color** to change the focus between the 2D and Color images and controls.
7. To exit color mode, tap **C** or **2D**.

Color imaging controls

Table 21. Controls available in Color

Control	Use	Available in	
		Live	Frozen
Color Baseline	Tap the up or down arrows to move the baseline. Repositioning the color baseline can optimize for the aliasing velocity.	✓	✓
Color Compare	Color Compare displays two versions of the image. One version displays 2D and color, and the other version displays 2D only. <ol style="list-style-type: none"> 1. Tap the buttons to choose between left and right displays or top and bottom displays. 2. Use the imaging controls to jointly optimize both versions of the image or clip and view the cine loop. 	✓	—
Show/Hide Color	Tap the button on the control to show or hide color, allowing you to view the 2D image with or without the color graphics.	✓	✓
Color Flow	On the Color Flow control, tap one of the following: <ul style="list-style-type: none"> • High optimizes for high blood flow areas, minimizing flash artifacts. • Med optimizes for medium blood flow area such as an artery. • Low optimizes for low flow areas such as breast, venous, or musculoskeletal. For a more precise setting, adjust the Color Scale control.	✓	—
Color Scale	Tap the up or down arrows to adjust the color scale.	✓	—
Color Type	Tap one of two choices: Color and CPD ; Color and Var . The choice depends on transducer and exam type. See Scanning in Color [74] for an explanation of color types.	✓	—
Dual	<ol style="list-style-type: none"> 1. Tap the right or left buttons to scan the right or left images. 2. Tap the opposite button (L or R) to scan the opposite image. You can also tap the right or left images to switch between the images. See Scanning in dual mode [76] .	✓	✓
Invert	Turn on or off by tapping the button on the control. Switches the displayed direction of the blood flow and reduces the need to reposition the transducer.	✓	✓
Power	Tap the arrows on the control to adjust the transmit power levels to the desired range while maintaining adequate image quality. MI (mechanical index) and TI (thermal index) are updated accordingly.	✓	—
Print	Tap the button to print the current screen image to a configured external printer.	✓	✓
Steering	Tap a setting to optimize the display of color for the direction of the blood flow (linear transducers only). You can also steer the color box by swiping left or right on the touchscreen.	✓	—

Control	Use	Available in	
		Live	Frozen
Wall Filter	Tap to select the strength of the filter: Low , Med , or High . Wall Filter removes low level echoes on each side of the baseline. A higher filter correlates to a higher cutoff velocity.	✓	—
Zoom	<ul style="list-style-type: none"> • During live imaging, tap the magnifying glass (for further details, see Zooming [78]). • When the image is frozen, tap the up or down arrows to increase or decrease the zoom. 	✓	✓

Scanning in dual mode

Dual displays two separate 2D or color images side by side. The system supports independent image information for each dual side (for example, depth and orientation markers), and you can view frames in the cine buffer for each image independently. You can also switch between the two images to adjust some controls including depth, mode, and gain.

You can use dual imaging to display the same structure in two different planes. Dual imaging can also be used to display two adjacent areas of the body.

1. On the **Dual** control, tap **L** to start dual imaging with the left-hand image active.
2. Scan to obtain your first image, and adjust controls as needed.
3. Tap the right image area to change to the inactive side.
4. Scan to obtain your second image, and adjust controls as needed.
5. To view independent cine buffers for side by side images, see [Viewing frames in the cine buffer \[78\]](#). Make sure to activate each side, as needed.
6. On the **Dual** control, tap the highlighted button to turn dual mode off

Scanning in simultaneous mode



NOTE

Doppler imaging is available as a licensed option in some countries .

Simultaneous or triplex imaging assesses body structures simultaneously in two modes (2D and PW Doppler) or three modes (2D, color Doppler, and PW Doppler). See [Selecting a transducer and exam type \[26\]](#) for compatible exam types and transducers.



WARNING

The PW Doppler sensitivity and waveform appearance in simultaneous imaging may be inferior to that in non-simultaneous Doppler imaging modes. You can turn off simultaneous imaging to confirm Doppler waveform characteristics.

1. Tap **D** to begin Doppler imaging.

2. Tap **D** again to display the scrolling image.
3. Tap the button on the control to turn on **Simultaneous**.
If this control is hidden, tap **+ More Controls** to access it.
4. Scan the image in 2D and PW Doppler, or 2D, Color Doppler, and PW Doppler.
You can adjust imaging controls for each of the three modes.
5. To view independent cine buffers for side by side images in simultaneous Doppler, see [Viewing frames in the cine buffer \[78\]](#).

Adjusting the depth

Depth refers to the depth of display. You can adjust the depth in all imaging modes except Doppler sweep. Depth controls are unavailable when the image is frozen.

As you adjust the depth, the depth value appears in a rectangle in the lower right corner of the image area or upper right corner if the image orientation is upside-down.



NOTE

The depth value in the lower right corner of the clinical monitor is always the total acquired depth of the unzoomed image. When you zoom, this value stays the same.

To increase or decrease the depth, use the slider on the touchscreen.

Adjusting the gain

Gain refers to amplifying the intensity of the returning sound waves on the display. In 2D mode, increasing the gain brightens the image. Decreasing the gain darkens the image. When you are in Color mode, the gain controls adjust the intensity of the signals within the color box.

Gain controls are unavailable when the image is frozen.

You can adjust the gain by tapping **Auto** or adjusting the slider on the clinical monitor.

Adjusting gain automatically

Tap **Auto** on the touchscreen.

The system automatically balances the gain each time you use the automatic control. Automatic gain adjustment does not occur continuously. If needed, use the control again when adjustments are made to the image or the location of the transducer.

You can use the **Auto Gain Adjust** imaging control to adjust the target brightness level the system uses when you use the **Auto** feature. This customization can be saved, along with other optimizations, to a custom exam type.

Adjusting gain by using the TGC sliders

1. The **TGC** control appears after the 2D gain slider is adjusted.
2. Do one or more of the following:
 - Drag the near gain slider left or right to decrease or increase the near gain, which adjusts the gain at shallow depths.

- Drag the middle gain slider up or down, left or right to adjust the gain at the middle depths of the image.
- Drag the far gain slider left or right to decrease or increase the far gain, which adjusts the gain at deeper depths.
- Drag the bottom gain slider left or right to affect the overall gain.

Resetting the gain

Do one of the following:

- Tap the button on the **Reset Gain** control.
- If you are using the TGC sliders, double tap on the gain centerline.

Zooming

You can freeze or unfreeze the image or change the imaging mode while zooming, but you cannot use the on-screen time gain compensation (TGC) controls. When you zoom in on an image, the magnifying glass icon appears on the image.

Zooming during scanning

1. On the **Zoom** control, tap the magnifying glass icon.
A zoom box appears on the image.
If this control is hidden, tap **+ More Controls** to access it.
2. Position the zoom box by dragging it on the touchscreen.
3. Size the zoom box by touching and moving the circle at the bottom-right corner.
4. Tap the **Zoom** control again to zoom in on the selected area.
5. To exit zoom, do one of the following:
 - Tap **Unzoom**.
 - Tap **2D**.

Zooming on a frozen image



1. Freeze the image .
2. Tap the up or down arrows on the **Zoom** control to increase or decrease the magnification of the current image.
If this control is hidden, tap **+ More Controls** to access it.
3. (Optional) Pan the image by dragging your finger left, right, up, or down on the touchscreen.

Viewing frames in the cine buffer

While imaging, the system always retains a certain number of frames in the cine buffer. You can move forward and backward in the cine buffer. The system clears the cine buffer when you unfreeze the image or press **2D**.

You can view frames in the cine buffer during dual and simultaneous imaging. See [Scanning in dual mode \[76\]](#) and [Scanning in simultaneous mode \[76\]](#)

1. Freeze the image .
On a frozen image, the cine icon and bar appear on the left side of the monitor.

2. Tap  or  on the cine control bar to move forward or backward frame by frame.

Voice commands

The Voice Assist feature is designed to optimize recognition by recognizing the specific English only voice commands displayed in the following table. The system listens for a command for 20 seconds. The timer restarts with each command.

Table 22. Voice commands

Specific voice command	Description
Activate Voice	Activates voice control Until you speak this command, the system does not recognize any other voice commands.
Reduce Depth	Moves the depth up to view structures closer to the skinline
Increase Depth	Moves the depth down to view structures farther from the skinline
Brighter	Increases the gain
Darker	Decreases the gain
Autogain	Adjusts the gain automatically
Freeze	Freezes the image
Unfreeze	Unfreezes the image
Image Save	Saves the image
Clip Save	Saves the clip
Image Print	Print the image
Color On	Turns Color mode on
Color Off	Turn Color mode off
Needle Profiling On	Turn steep needle profiling (SNP) on
Needle Profiling Off	Turn steep needle profiling (SNP) off
Other Side	Switch needle profiling enhancement area
Needle Guide On	Turns the needle guide on
Needle Guide Off	Turn needle guides off
Centerline On	Turn the centerline on
Centerline Off	Turn the centerline off

Using voice commands

1. Connect the FUJIFILM Sonosite microphone into a USB port.
2. On the general settings page, select the type of English you want the system to recognize: US or UK.
This setting persists.
3. To first enable Voice Assist, tap the microphone icon on the touchscreen.
The English voice commands recognized by the system are displayed.
4. Speak the command that activates active listening mode "Activate Voice."
5. Use any of the displayed voice commands (see [Voice commands \[79\]](#)).
The system listens for a recognizable command for 20 seconds with the timer restarting with each command.
6. If needed, reactivate listening mode by speaking the command "Activate Voice."
7. To turn off the Voice Assist feature, tap the on/off control.

Using the centerline

The centerline graphic aligns with the center mark of the transducer and serves as a reference mark for the center of the displayed image during live 2D imaging. The centerline graphic is currently available for the following transducers and exam types.

Table 23. Exam types compatible with the centerline

Exam type	Transducer					
	C5-1	C10-3	L12-3	L13-6	L15-4	L19-5
Abdomen	✓	✓	—	—	—	—
Arterial	—	—	✓	—	✓	✓
Breast	—	—	✓	—	✓	—
Carotid	—	—	✓	—	✓	—
MSK	✓	✓	✓	✓	✓	✓
Nerve	✓	✓	✓	—	✓	✓
Procedural Abdomen	✓	—	—	—	—	—
PIV	—	—	✓	✓	—	✓
Spine	✓	✓	—	—	—	—
Superficial	—	—	✓	✓	✓	✓
Vascular Access	—	—	—	—	—	✓
Venous	—	—	✓	✓	✓	✓



WARNING

When using the centerline feature as a reference during a freehand needle procedure, be aware that the centerline represents only the center of the ultrasound image and is not an accurate predictor of the path the needle will take.

Figure 5. Relationship of the centerline graphic to the transducer and the ultrasound image

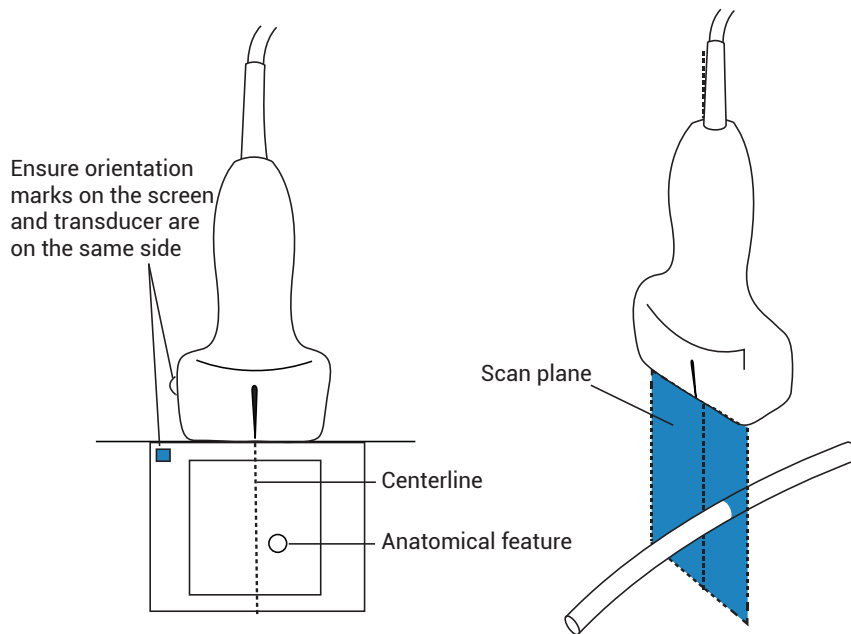

Small tilts or rotations of the transducer can affect the relationship between any external reference points and the anatomy that appears on the ultrasound image.

Figure 6. Relationship of the ultrasound image to the transducer angle or tilt.

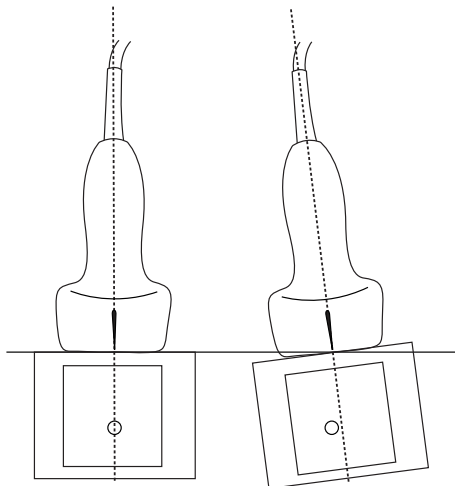

Turning the centerline graphic on or off

- Tap the button on the **Centerline** control.
Centerline is not available when using the Needle Guide control.

Needle profiling



WARNING

- To avoid incorrect needle placement when needle profiling is on:
 - Using movement and fluid injection, verify the needle-tip location and trajectory. Needle profiling enhances linear structures within a selected angle range on the ultrasound plane. Linear structures outside the selected angle range or the ultrasound plane—such as a bent needle—may be less apparent.
 - Note that linear structures are enhanced only in an outlined portion of the image. The area outside the outline remains unchanged.
 - Note that the beam divergence of a curved array transducer may prevent a segment of the needle shaft from showing in the image. The needle tip may not appear in all imaging conditions.
- Too much gain or motion (respiratory or heart) can cause an increase in image artifacts when needle profiling is enabled.

Sonosite ST features enhanced Auto Steep Needle Profiling technology. This technology can facilitate needle guidance during catheter placement and nerve-block procedures and enhances linear structures within an outlined area on the screen. The needle is enhanced with a variable amount of intensity within the imaging beam slice thickness. The enhancement of the needle and its tip is brightest and most precise when the needle is centered within this imaging beam. Needle profiling technology simultaneously visualizes the needle shaft at shallow, medium, and steep angles. Linear structures are best enhanced when perpendicular to the angle guide.

Auto Steep Needle Profiling is a licensed option.

Figure 7. Image with needle profiling on



The area within the green trapezoidal outline is the enhancement area.

For curved array transducers, technology can help identify the direction of the needle, although only segments of the needle shaft may show in the image. Use movement and fluid injection to help verify the needle tip location.

Figure 8. Needle profiling with a curved array

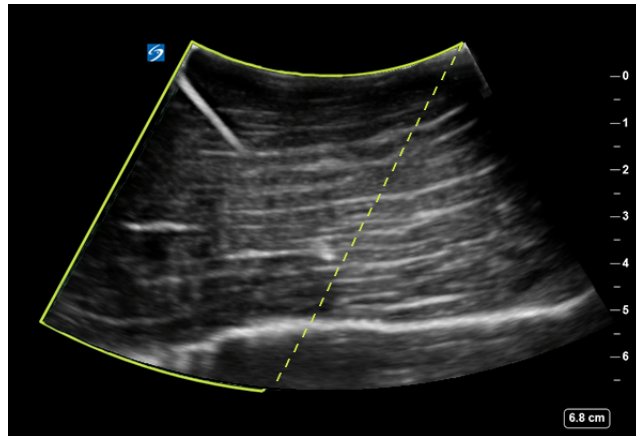

Needle profiling is available in 2D full-screen imaging only and on the following exam types.

Table 24. Exam types compatible with needle profiling

Exam type	Transducer				
	C5-1	L12-3	L13-6	L15-4	L19-5
Arterial	—	✓	—	✓	✓
Breast	—	✓	—	✓	—
Carotid	—	✓	—	✓	—
MSK	✓	✓	✓	✓	✓
Nerve	✓	✓	—	✓	✓
PIV	—	✓	✓	—	✓
Spine	✓	—	—	—	—
Superficial	—	✓	✓	✓	✓
Vascular Access	—	—	—	—	✓
Venous	—	✓	✓	✓	✓

Using needle profiling

1. In 2D imaging, tap one of the icons on the **Needle Profiling** control to change the enhancement area from one side of the image to another.
If this control is hidden, tap **+ More Controls** to access it.
2. Insert the needle toward the angle guide (dotted line).
3. (Optional) To help identify artifacts or other structures, tap **Needle Profiling** to turn it off.
Tap again to turn it back on.

Needle size and angle

Use a 17-gauge to 25-gauge needle (recommended). Enhancement results can depend on the type and brand of needle used. For more information, consult the medical literature on needle visibility in ultrasound-guided procedures.

You can angle the needle up to 50° from the transducer surface. Beyond 50°, the needle may be less enhanced. (Needle Profiling has little or no benefit to out-of-plane procedures. Needle Profiling is intended for in-plane procedures only.)

Figure 9. Needle size and angle

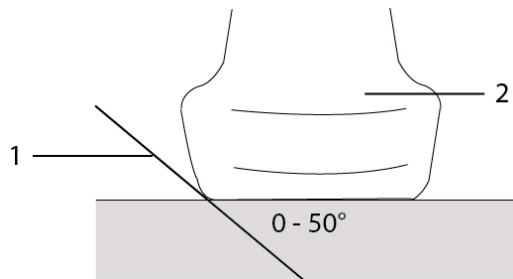

1. Needle 2. Transducer

Needle guide control



WARNING

The needle tip may not be visible when performing a needle guide procedure, making it difficult to tell when the target has been reached. Use movement and fluid injection to verify the needle-tip location.

The needle guide control generates an on-screen graphical needle guide when using a supported transducer with an attached needle bracket. The system does not generate on-screen needle guides for variable angle needle brackets, which can be used with a number of transducers. For further information, see *Using CIVCO Products with FUJIFILM Sonosite Systems*.

Two different types of graphics are generated depending on the type of bracket used:

- Fixed-angle, in-plane brackets: a pair of guidelines are generated that represent the anticipated path of the needle. The needle path tolerance is 1 cm from where the needle enters the image to 1.54 cm at the maximum needle depth. The displayed number for depth is accurate within +/- 4 mm.
- Transverse-angle, out-of-plane brackets (depths are adjustable): the guidelines appear as dots down the center of the image. The needle guidance accuracy is +/- (10% of target depth plus 0.5 mm offset) from the target point axially and +/- (5% of target depth plus 0.5 mm offset) from the target point and guidelines laterally.

Table 25. Needle guide control availability

Available with	Not available with
IC10-3 (fixed-angle)	variable angle needle brackets
L19-5 (transverse-angle)	a reduced field of view
	the centerline feature

Using the needle guide control

1. While scanning in 2D, tap the **Needle Guide** control to turn on the needle guide graphic.
2. For transverse-angle brackets, use the depth control buttons on the touchscreen to change depth. The needle depth indicators on the clinical monitor adjust accordingly.

Managing Images and Clips

Sonosite ST includes tools for capturing, saving, labeling, and reviewing your ultrasound images and clips.

Saving an image or a clip

Images and clips are saved to the current study, which is the study that is open during the scan. You can also append images and clips to a study that has ended by starting a new study with the same patient information. See [Appending images and clips to a study \[122\]](#).



WARNING

To avoid mixing up images saved from multiple patients, make sure that the correct patient ID is displayed before you save an image. For more information about patient records, see [Entering Patient Information \[61\]](#).

The number of images and clips saved to the current study is displayed on the touchscreen. The maximum number of images and video clips that you can save for an individual study depends on a number of factors. The system warns you when this limit is reached.

The system allows you to:



- Save an image during live or frozen imaging
- Save images from cine while the system is frozen

Saving an image



During live or frozen imaging, tap .

The system informs you that the image is saved.

Setting clip controls

1. During live imaging, tap **Video Clip Settings**.
If this control is hidden, tap **+ More Controls** to access it.
2. In the video clip settings dialog, select one of the following under **Clip method**:
 - **Prospective** captures frames after you press . The system captures frames for the number of seconds you specify in the **Seconds** list. A forward clip symbol displays in the system status area .
 -
3. Under **Clip type**, select **Seconds** to capture clips based on the number of seconds and select the time duration from the drop-down list box.
4. Tap **Done**.

Saving a clip

1. While scanning, tap .
While the clip is being recorded, the clip control is blue and the clip symbol displays in the system status area.
2. To stop recording, tap .
If you have chosen a prospective clip, the control beeps letting you know that the clip is saved.

Labeling images

You can label live or frozen images with text (including predefined labels), arrows, and pictographs.

Displaying the labeling page

1. Tap the **ABC** button to display the default text labels page.
An active cursor appears on the touchscreen in the default home location. You can move the cursor to another location by tapping the touchscreen.
2. To close the labeling page, tap the **ABC**, or freeze  button.

Setting labeling options

1. Tap the **ABC** button to display the labeling page.
2. To switch the labeling package, tap the drop-down menu and select another package.
3. To clear all labels when unfreezing an image, do the following:
 - a. Tap .
 - b. Tap **Clear on unfreeze** on.
 - c. To exit the menu, tap outside of the menu box.







NOTE

Clear on unfreeze also clears labels when you switch a transducer or an exam type.

Adding, moving, and editing a text label

You can add text manually or add a predefined label.

1. Tap the **ABC** button or tap **Text** to display the text labels page.
A cursor appears at the home position on the monitor.
2. If you are adding a predefined label, select a labeling package from the drop-down menu.
You may need to scroll to display all the labels in the group.
3. To manually enter text, display the on-screen keyboard by tapping the keyboard icon .
4. If desired, tap a location on the touchscreen to move the cursor to another location.
5. Enter text manually using the on-screen keyboard or tap predefined labels.
After adding a label, the label background is highlighted and you can move or edit the label.
6. Do any of the following:
 - To move the label, use the touchscreen to drag the label to the desired location on the clinical monitor.

- To edit the label, move the cursor within the text box and use the on-screen keyboard  to edit the text.
7. To begin a new label, do one of the following:
 - Tap another location on the touchscreen.
 - Tap the return key  on the on-screen keyboard.
 8. To reselect a label, tap the label.
 9. Tap  to finalize the labels and save the image.



Adding arrows

You can add a maximum of five arrows to point out specific parts of the image.

1. Display the labeling page, then tap **Arrow** to display the arrow label page. A highlighted arrow appears on the arrow label page and the clinical monitor.
2. Tap on the arrow to switch between highlighting the arrow or highlighting the rotational circle around the arrow.
3. If the arrow is highlighted, move it by dragging your finger on the touchscreen.
4. If the rotational circle is highlighted, rotate the arrow clockwise or counterclockwise on the touchscreen.
5. To create a new arrow, tap **Add arrow**. You can select arrows by tapping them on the touchscreen.
6. Tap  to finalize the labels and save the image.

Adding pictographs

Available pictographs depend on the selected labeling package. Only one pictograph can be placed on each image.





1. Display the labeling page, then tap **Picto** to display the pictograph page.
2. Tap the desired pictograph on the page to display it on the scanned image.
3. Adjust the icon that represents the position of the transducer relative to the image  :
 - To change the location of the icon relative to the pictograph, drag the highlighted icon using the touchscreen.
 - To change the orientation of the icon relative to the pictograph, tap it to select it, and then rotate the icon by dragging your finger on the touchscreen.
4. To change the location of the pictograph and orientation icon on the clinical monitor, tap it to select it, and then drag the highlighted pictograph using the touchscreen.
5. To replace the pictograph, tap another pictograph on the page.
6. Tap  to finalize the labels and save the image.

Using the home position

The home position is the position where the system places labels by default. Text and pictograph labels have a different home position.

- To return a label to the home position, select a label on the monitor and tap **Move to Home**.
- To change the home position, move the cursor or a selected label on the monitor and tap **Set Home**.

Deleting labels

1. To delete a text label, do one of the following:
 - To delete text in the text box, tap the .
 - To delete the last word of the most recently created or edited phrase, tap **Delete Word**. Continue deleting words by tapping the button multiple times.
 - To delete the most recently created or edited phrase, tap **Delete Line**.
 - To delete all text labels, tap **Delete All Text**.
2. To delete an arrow, tap the  or the  on the touchscreen.
3. To delete a pictograph, tap the  or the  on the touchscreen.
4. To delete all labels, tap **Clear All Labels**.

Printing images

To adjust printer settings, refer to the user guide that comes with the printer.



WARNING

Use only accessories and peripherals recommended by FUJIFILM Sonosite. Connection of accessories and peripherals not recommended by FUJIFILM Sonosite could result in electrical shock and system malfunction. Contact FUJIFILM Sonosite or your local representative for a list of accessories and peripherals available from or recommended by FUJIFILM Sonosite.



CAUTION

Printing an image does not necessarily capture all of the characteristics of the image displayed on the monitor. The printout is intended for documentation purposes, and may not be suitable for diagnosis. The printed image is subject to degradation due to age and ambient light conditions.



NOTE

The printer icon displayed on the clinical monitor tells you whether or not the printer is physically connected to the system.

Printing while imaging

1. Make sure that the power button on the printer is in the On position.
2. With the image displayed, tap the **Print** control .

Printing a saved image from the current study

1. Make sure that the power button on the printer is in the On position.
2. Open the review page by doing one of the following:
 - Tap a thumbnail image or clip.
 - Tap **Review Images**.
3. Tap the check box for each image you want to select.
4. Tap **Send to**.
5. Tap **Printer**.

Printing a saved image from an ended study

1. Make sure that the power button on the printer is in the On position.
2. Tap **Patient List**.
3. To open a study review page, do one of the following:
 - Tap a study to select it, tap **View** and then tap **Review Images**.
 - Double-tap on the study. Tap the check box for each image you want to select.
4. Tap **Send to**.
5. Tap **Printer**.

Archiving and exporting images and clips

Saved images and video clips are organized in patient studies. To export and archive studies, see [Managing Patient Data \[121\]](#).

Exporting individual images and clips

You can export individual images and clips to a USB storage device for viewing in the USB Image Gallery. Individually exported images and clips do not contain study information.



NOTE

Use this method of export to produce only individual image and clip files. This method of export does not export the complete patient study, and the study does not display the USB export icon in the study list.

1. Connect a USB storage device (see [Inserting and removing USB devices \[19\]](#)).
2. Do one of the following to open the review page:
 - For the current study, tap thumbnail images or clips or tap **Review Images**. You can also tap **Review Images** from the Report & Worksheet page.
 - For a completed study, tap **Patient List**. Select a study and tap **View** then **Review Images**, or double-tap to open the study review page.
3. Select the check box next to each image or clip that you want to export.
4. Tap **Send to**.
5. Tap **USB**.
6. If more than one storage device is available, tap to select the storage device where you want to export your images.

7. To change the file name, tap the **Enter filename** field and then type the new file name using upper and lower-case letters and numbers only (no special characters or spaces).



NOTE

All images and clips exported to the USB storage device are stored on the root level of the drive. This is to facilitate viewing in Image Gallery. Files with the same name will have the name automatically incremented.

8. By default, patient information such as names and IDs are removed from images and clips before exporting. Patient information can be included during export by selecting the **Include patient information on images and video clips** check box.



CAUTION

Patient information might be a protected class of patient data subject to country-specific security guidelines. If you choose to include patient information when exporting images and clips, be sure your information storage and handling practices comply with country-specific security guidelines.

9. Tap **Export**.

Image gallery

The Image Gallery enables you to view images and video clips from a USB storage device. You should only display images provided by FUJIFILM Sonosite or captured on the ultrasound system. Do not use a USB that contains any external clinical or non-clinical images in the image gallery.



WARNING

Images in the image gallery should not be used for diagnostic purposes.

Viewing images using Image Gallery

1. Connect a USB storage device (see [Inserting and removing USB devices \[19\]](#)).



NOTE

The image and clip files that you want to view must be stored on the root level of the USB storage device in order for Image Gallery to access them.

2. Tap the system menu , and then tap **USB Image Gallery**.
3. On the USB image gallery page, select your desired storage device from the list. A gallery of available images and clips appears.
4. To open a full-screen view of an image or clip on the clinical monitor, tap the thumbnail image.

Measurements and Calculations



This section provides information about measurements and calculations. Measurements and calculations, along with patient information and worksheet findings, are collected into the study report.

Performing measurements and calculations



WARNING



- To avoid incorrect calculations, verify that the patient information, date, and time settings are accurate.
- To avoid misdiagnosis or harming the patient outcome, make sure you end the previous study before starting a new patient study and performing calculations. Otherwise, the previous patient's data will be combined with the current patient. Tap **END STUDY** to end the previous study.
- To avoid misdiagnosis or harming the patient outcome, do not use single calculations as sole diagnostic criteria. Use calculations in conjunction with other clinical information.

Measurements and calculations are accessible through both the caliper  and calculation  buttons. Tap caliper  to directly access basic measurements and calculations that are not saved to the patient report. You can access measurements and calculations that are saved to the report by tapping the **Calcs** tab in the control panel. Measurements and calculations that include a pound symbol (#) indicate a value that is out of range.

Working with calipers

You perform measurements by dragging active, highlighted calipers into position on the touchscreen. Use the circle around the caliper to manipulate it. Calipers appear as cross-hairs when positioned at endpoints.

If calipers are not positioned correctly, the calculation result will be inaccurate.

1. On a live or frozen image, press the **Caliper/**  or **Calcs/**  button. (To do most measurements, freeze the image first by pressing )
A caliper for the default measurement and a control panel of available measurements appear on the touchscreen.
2. Tap the measurement you wish to perform or continue if you want to perform the default measurement.
3. Use the touchscreen to drag the active caliper to the desired position on the monitor.
4. Tap the active caliper to inactivate it or tap **Next** to activate the next caliper, and then position the next caliper on the touchscreen.

5. Do any of the following:



NOTE

Some measurements are associated as ordered sets. Tap **Next** to activate the next caliper tool.

- To switch between calipers, tap the active caliper or tap another caliper.
- To deselect the calipers and set the measurement values, tap on the touchscreen away from the measurement.

6. To save an image with displayed calipers and results, tap



NOTE

Measurements accessed from the Calipers page are only saved as part of the image, while measurements accessed from the Calcs page are also saved to the patient report.

7. To exit caliper mode, do one of the following:

- If you are performing a frozen measurement, tap the button or an imaging mode button to return to live imaging.
- If you are performing a live measurement, tap **Caliper/** again.

Viewing measurements and calculations

Measurement and calculation results appear on both the image and measurement areas in the order that they are completed. A maximum of 10 measurements can be displayed.

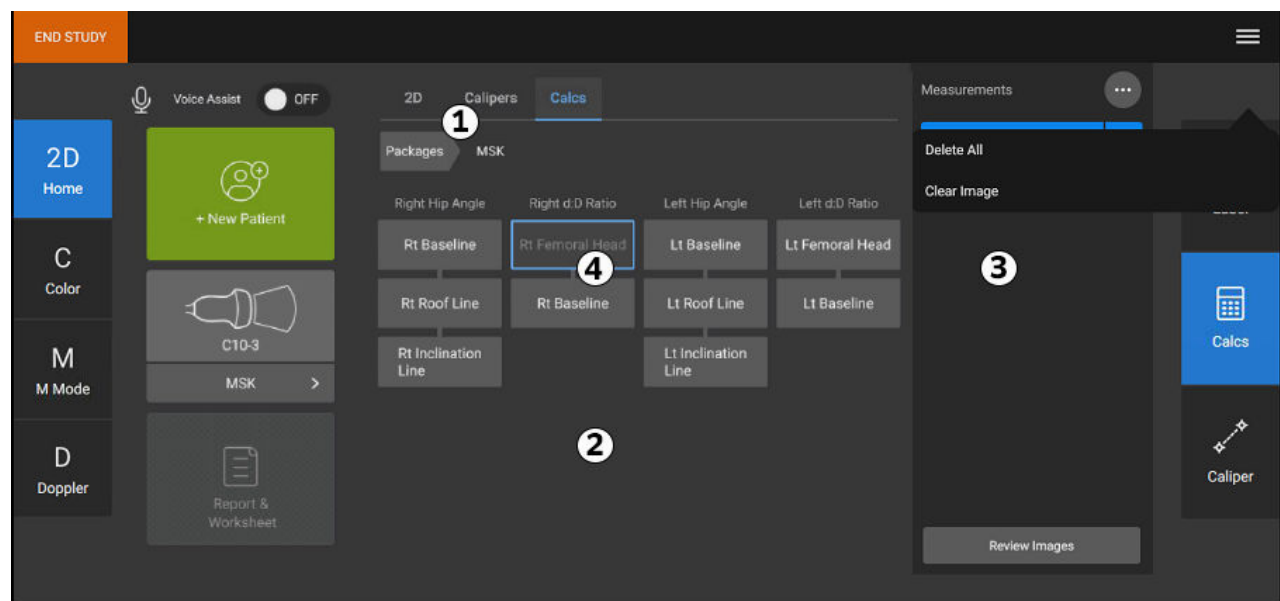

Figure 10. Example of a measurements and calculations page



1. Navigation menu 2. Measurement buttons 3. Results area 4. Ordered measurement set

Deleting a measurement

Do any of the following:

- Tap the delete icon  next to the measurement.
For calculations with multiple measurements, the measurement selected is removed from the patient report. If it is the only measurement required for a calculation, the calculation result is also removed from the report.
- To remove all measurements visible on the touchscreen, tap **Clear Image** from the  menu. This does not remove measurements from the report.
- To delete all visible measurements from the report, image, and system memory, tap **Delete All** from the  menu.
This does not delete measurements that have been previously saved to the report and are no longer visible on the main touchscreen.

To delete a measurement directly from the report, see [Deleting calculation values from the report \[127\]](#).

Editing a new measurement

- Select an unsaved measurement to edit by tapping its name in the results area.
The last caliper used for the measurement is activated.

Basic measurements in 2D and Color





NOTE

When scanning in dual mode, you can only measure across images if you are using a linear transducer and if the images are at the same depth and magnification.



Basic measurement tools available in 2D/Color imaging are:

Distance (cm)	Target depth (cm)
Ellipse (circumference, diameter, and area)	Trace
Curved distance (cm)	Angle (degrees)
Volume	Volume flow (also includes a Doppler measurement)
	See Volume flow [100]



Measuring the distance between two points

1. On a frozen 2D/color image, tap the **Caliper/**  button.
The default distance caliper appears.
2. If you have been performing other measurements, tap **Distance**.
3. Use the touchscreen to drag the active caliper to the first point.
4. Use the touchscreen to position the second caliper at the second point.
5. As needed, tap calipers to select and reposition them on the touchscreen.
6. Tap  to save an image with the measurement.

Measuring a curved distance

1. On a frozen 2D/color image, tap the **Caliper/**  button.
2. Tap **Curved Distance** on the caliper page.
3. Use the touchscreen to drag the active caliper to the first point.
4. Lift your finger from the touchscreen.
A pencil icon appears, indicating that the start location is set and you can begin your trace.
5. Use the touchscreen to drag the caliper around the area you want to trace.
To make a correction, trace backward on the line
6. Tap  to save an image with the measurement.

Measuring circumference, diameter, or area using an ellipse

1. On a frozen 2D/color image, tap the **Caliper/**  button.
2. Tap **Ellipse** on the caliper page.
An ellipse appears with three calipers.
3. Use the touchscreen to switch between selecting each of the calipers to move and resize the ellipse.
4. Tap  to save an image with the measurement.

Measuring circumference or area by tracing

1. On a frozen 2D/color image, tap the **Caliper/**  button.
2. Tap **Trace** on the caliper page.
3. Use the touchscreen to drag the caliper to the start point.
4. Lift your finger from the touchscreen.
A pencil icon appears, indicating that the start location is set and you can begin your trace.
5. Use the touchscreen to drag the caliper around the area you want to trace.
To make a correction, trace backward on the line
6. Lift your finger from the touchscreen.
The trace closes automatically and the measurement results appear.



NOTE

Even after completing the trace, you can still adjust the measurement by dragging the cursor. Drag the cursor backward to erase your trace, or drag it forward to extend it.

7. Tap  to save an image with the measurement.



Performing a target depth measurement

You can measure the distance from the skinline to a specified point on the image.





NOTE

The target depth measurement resets when you change imaging modes, depths, certain optimization settings, turn zoom on or off, or use needle guides.

1. On a frozen 2D/color image, tap the **Caliper/**  button.
The caliper defaults to the target depth measurement during live imaging.
2. If the image is frozen, tap **Target Depth**.
A dotted line appears, extending from the skinline to a single caliper at the end.
3. Use the touchscreen to position the caliper
4. Tap  to save an image with the measurement.

Measuring an angle between two connected lines

1. On a frozen 2D/color image, tap the **Caliper/**  button.
2. Tap **Angle** on the caliper page.
Three calipers appear.
3. Use the touchscreen to position the active caliper.
4. Use the touchscreen to position the second caliper.
5. Use the touchscreen to position the third caliper.
6. Tap  to save an image with the measurement.

Measuring volume

The volume measurement is based on one, two, or three 2D distance measurements for height, width, and length. After any measurement is saved, the volume calculation appears on the monitor. You can calculate up to three volumes.

1. On a frozen 2D/color image, tap the **Caliper/**  button.
2. Tap **Volume 1**, **Volume 2**, or **Volume 3** on the caliper page.
3. Do the following for each measurement you need to take:
 - a. Tap the measurement (**Length**, **Width**, or **Height**).



NOTE



You can only take two of the three measurements on any one imaging plane. Use the cine control, or freeze/unfreeze, to select a different frame and take the third measurement.

- b. Use the touchscreen to position the first caliper.
- c. Use the touchscreen to position the second caliper.
- d. Tap  to save an image with the measurement.



Basic measurements in M Mode

Measuring distance and time

You can measure distance in centimeters, time in milliseconds, and slope in centimeters per second.

1. On a frozen M Mode sweep, tap **Caliper/**  .
The default distance time caliper appears.
2. If you have been performing other measurements, tap **Distance/Time** on the caliper page.
3. Use the touchscreen to position the caliper
4. Use the touchscreen to position the second caliper.
5. Tap  to save an image with the measurement.

Measuring heart rate (M Mode)

1. On a frozen M Mode sweep, tap **Caliper/**  .
2. Tap **Heart Rate** on the caliper page.
A pair of vertical calipers appear.
3. Use the touchscreen to drag the active caliper to the peak of the heartbeat.
4. Use the touchscreen to drag the second caliper to the peak of the next heartbeat.
5. Tap  to save an image with the measurement.



NOTE

Saving the heart rate measurement to the patient report does not overwrite the heart rate entered on the patient form.

Basic measurements in Doppler



NOTE

Doppler imaging is available as a licensed option in some countries .

The basic measurements that you can perform in Doppler imaging are:

Velocity/Velocity pair (cm/s)	Slope (cm/s ²)
Heart rate	Time (msec)
Manual trace	Auto trace
Volume flow (also includes a 2D measurement)	
See Volume flow [100]	

Performing these measurements can also calculate the following, depending on the analysis package:



Time	Pressure gradient or max pressure gradient (PG or PG Max)
End diastolic velocity (EDV)	Pulsatility index (PI)
Mean pressure gradient (PG Mean)	Resistive index (RI)
Mean velocity (VMean)	S/D ratio (S/D)
Minimum diastolic velocity (MDV)	Time average mean (TAM)
Minimum velocity (VMin)	Time average peak (TAP)
Peak systolic velocity (PSV)	Velocity time integral (VTI)
Peak velocity (VMax)	

Measuring heart rate (Doppler)

See [Measuring heart rate \(M Mode\) \[97\]](#), but start from a frozen Doppler spectral trace.



Measuring velocity

This measurement involves a single caliper from the baseline. In cardiac analysis packages, measuring velocity also calculates PG.

1. On a frozen Doppler spectral trace, tap the **Caliper/**  button.
The default velocity caliper appears.
2. If you have been performing other measurements, tap **Velocity** on the caliper page.
3. Use the touchscreen to drag the caliper to a peak velocity waveform.
4. Tap  to save an image with the measurement.

Measuring a velocity pair

This measurement replaces the single velocity measurement in certain calculations. Depending on the analysis package, a velocity pair can measure PSV, EDV, RI, and S/D.

1. On a frozen Doppler spectral trace, tap the **Caliper/**  button.
The default velocity caliper appears.
2. If you have been performing other measurements, tap **Velocity** on the caliper page.
3. Use the touchscreen to drag the caliper to a peak systolic waveform.
4. Tap **Next**.
A second caliper appears.
5. Use the touchscreen to drag the second caliper to end diastole on the waveform.
6. Tap  to save an image with the measurement.



Measuring time duration

1. On a frozen Doppler or M Mode trace, tap the **Caliper/**  button.
2. Tap **Time** on the caliper page.
A pair of vertical calipers appears.
3. Use the touchscreen to position the caliper
4. Use the touchscreen to position the second caliper.

5. Tap  to save an image with the measurement.

Measuring slope

The slope tool uses one or two calipers. A single caliper measures velocity and PG, while two calipers measures Slope, Time, VMax, VMin, and PG Max (depending on the analysis package).

1. On a frozen Doppler spectral trace, tap the **Caliper/**  button.
2. Tap **Slope** on the caliper page.
3. Use the touchscreen to position the caliper
4. To measure slope, time, VMax, VMin, and PG Max instead of velocity and PG, tap **Next**. A second caliper appears.
5. Use the touchscreen to position the second caliper.
6. Tap  to save an image with the measurement.

The absolute slope between the calipers is calculated. If the absolute velocity of the earlier caliper is greater than that of the later caliper (and they are on the same side of the baseline), the system calculates time, VMax, VMin, and PG Max.



Performing Doppler trace measurements

Trace measurements depend upon the analysis package and measurement tool. For an explanation of terms and abbreviations, see the [Glossary \[264\]](#).

Table 26. Doppler trace measurements available by exam type

Crd/Focused Crd	Abd/Bre/Gyn/MSK/OB/ Proc Abd/ PIV/Oph/ Pro/Sup/Vasc Access/Ven	Nerve/Spine	Art/Carotid	TCD/Orb	Lung
<ul style="list-style-type: none"> • VMax • VTI • PG Max • PG Mean • VMean 	<ul style="list-style-type: none"> • PI • RI • S/D • PSV • EDV • MDV 	<ul style="list-style-type: none"> • PI • RI • S/D • PSV • EDV • MDV • VTI 	<ul style="list-style-type: none"> • PI • RI • S/D • PSV • EDV • MDV • VTI • TAP 	<ul style="list-style-type: none"> • PI • RI • S/D • PSV • EDV • MDV • TAP • Gate Depth 	<ul style="list-style-type: none"> • PSV

Performing manual trace measurements

1. On a frozen Doppler spectral trace, tap the **Caliper/**  button.
2. Tap **Manual Trace** on the caliper page.
3. Use the touchscreen to drag the caliper to the beginning of the desired waveform. After lifting your finger off the touchscreen, a pencil icon appears, indicating that the start location is set and you can begin your trace.
4. Use the touchscreen to trace the waveform with the caliper. To make a correction, trace backward on the line
5. Tap  to save an image with the measurement.





NOTE

Even after completing the trace, you can still adjust the measurement by dragging the cursor. Drag the cursor backward to erase your trace or forward to extend it.

Performing automatic trace measurements

After measuring automatically, confirm that the system-generated boundary is correct. If you are not satisfied with the trace, trace manually.

1. On a frozen Doppler spectral trace, tap the **Caliper/**  button.
2. Tap **Auto Trace** on the caliper page.
You can select auto trace settings during scanning. See [Doppler imaging controls \[73\]](#).
3. Use the touchscreen to drag the active caliper to the beginning of the waveform.
4. Use the touchscreen to drag the second caliper to the end of the waveform.
5. Tap  to save an image with the measurement.

Volume flow

The volume flow measurement requires you to perform a basic measurement in 2D and a basic measurement on a Doppler trace.



WARNING

Diagnostic conclusions about blood flow based on VTI alone can lead to improper treatment. Accurate blood flow volume calculations require both the vessel area and velocity of blood flow. In addition, accurate blood flow velocity is dependent on a correct Doppler angle of incidence.

Consider the following factors when performing volume flow measurements:



- You should follow current medical practice for volume flow calculation applications.
- The accuracy of the volume flow calculation largely depends on the user's measurement technique.
- The factors identified in the literature that affect accuracy are as follows:
 - Using the diameter method for 2D area
 - Precision in placing the caliper
 - Difficulty ensuring uniform insonation of the vessel

For more information about the considerations and degree of accuracy for volume flow measurements and calculations, see the following reference:

Allan, Paul L. et al. Clinical Doppler Ultrasound, 4th Ed., Harcourt Publishers Limited, (2000) p.36-38.

Calculating volume flow

Repeat the following steps for each volume flow measurement you need to perform.

1. On a frozen 2D image or Doppler trace, tap **Caliper** / .
2. Tap **Volume Flow** on the caliper page.
[Step 3](#) and [Step 4](#) can be done in either order.
3. Measure blood vessel diameter:
 - a. Use the touchscreen to position the first caliper.
 - b. Use the touchscreen to position the second caliper.
 - c. Tap  to save the results.
4. Calculate the blood velocity:
 - a. Use the touchscreen to position each vertical caliper.
 - b. Tap  to save the results.

Calculations and analysis packages

You can perform measurements associated with analysis packages with the same measurement types used in the caliper menu. Tap on the measurement button to bring up the caliper.





Certain calculations can be adjusted by selecting their modifiers in the Calcs tab of the **Report & Worksheet** page. See [Modifying calculations in the report \[126\]](#).



NOTE

Calculations that require Doppler imaging are only available in some countries with the licensed option.

Accessing analysis packages

1. Freeze the image .
2. Tap **Calcs** / .
3. Navigate by tapping on a calculation type or analysis package.
4. Return to the previous menu or navigate to a different set of analysis packages by tapping on the **Packages** button in the navigation menu.
5. To exit calculations, do one of the following:
 - Tap the freeze button  to return to live imaging.
 - Tap the **2D** button.
 - Tap **Calcs** /  again.



Abdominal measurements and calculations

Abdominal measurements are listed in the following table along with calculation results that appear on the clinical monitor and in the report. For an explanation of terms and abbreviations, see the [Glossary \[264\]](#).

Table 27. Abdominal measurements and calculations

Page or list	Measurements (mode)	Procedure	Calculation results
Vessels	Ao Prox D, Mid D, and Dist D (2D)	Distance [94]	—
	IVC Max D and Min D (2D or M Mode)	IVC Collapse [112]	IVC Collapse
Abdomen	<ul style="list-style-type: none"> • Liver L (2D) • CHD (2D) • CBD (2D) • Spleen L (2D) 	Distance [94]	—
Gallbladder	GB Wall, Long, and Trans, (2D)	Distance [94]	—
Renal	Lt and Rt Kidney L (2D)	Distance [94]	—
Bladder	Pre-Void and Post-Void Bladder (2D)	Volume [96]	<ul style="list-style-type: none"> • Bladder Vol • Post-Void Bladder Vol
	<ul style="list-style-type: none"> • Length • Height • Width 		
Renal Aortic Ratio	Ao Prox (Doppler)	Velocity [98]	Rt and Lt Renal/Ao Ratio
	Rt and Lt Renal Art (Doppler)		

Performing an abdominal measurement or calculation

1. On a frozen image, tap **Calcs**  and navigate to the abdomen analysis package on the touchscreen (if you are imaging using the abdomen exam type, this package is preselected).
2. Tap a measurement button or select a measurement from the next page.
3. Perform the measurement according to its measurement type.
4. Tap  to save the results.

Cardiac measurements and calculations

This section lists the procedures required to make certain cardiac calculations. You can also refer to the basic measurements section for details on how to use the calipers. Cardiac measurements are listed in the following tables along with calculation results that appear on the clinical monitor and in the report. For an explanation of terms and abbreviations, see the [Glossary \[264\]](#).

The ultrasound system has two cardiac analysis packages; cardiac and focused cardiac.

Table 28. Cardiac measurements and calculations

Page or list	Measurements (mode)	Procedure	Calculation results
LV Function/EF	EF (2D)	EF/FS [108]	LV EF, LV FS
	<ul style="list-style-type: none"> • LVDd and LVDs 		
	Left FAC (2D)	FAC [108]	Left FAC
	<ul style="list-style-type: none"> • LV EDA and ESA 		
	CO	SV and CO [109]	CO, CI, SV, SI
	<ul style="list-style-type: none"> • LVOT D (2D) • LVOT VTI and CO HR (Doppler) 		

Page or list	Measurements (mode)	Procedure	Calculation results
	Simpson's EF (2D) <ul style="list-style-type: none"> • A4Cd and A4Cs Vol • A2Cd and A2Cs Vol 	LV volume and EF [109]	Biplane EF, A4C EF, A2C EF, LVs Biplane Vol, LVd Biplane Vol
Function	EF (M Mode) <ul style="list-style-type: none"> • LVDd and LVDs 	EF/FS [108]	LV EF, LV FS
	<ul style="list-style-type: none"> • MAPSE and TAPSE (M Mode) • EPSS (M Mode) • LVET (M Mode) 	<ul style="list-style-type: none"> • MAPSE/TAPSE [110] • Time [98] • M Mode distance [108] 	—
Left Dimensions	Diastole (2D) <ul style="list-style-type: none"> • RVDd, IVSd, LVDd, LVPWd 	<ul style="list-style-type: none"> • EF/FS [108] • Qp:Qs [110] 	EF, FS, IVS FT, LVPW FT, Qp:Qs
	Systole (2D) <ul style="list-style-type: none"> • IVSs, LVDs, LVPWs 		
	LA/Ao (2D) <ul style="list-style-type: none"> • LA D, LA Vol A4C and A2C, Ao Root D, Asc Ao D, LVOT D 	<ul style="list-style-type: none"> • Distance [94] • Atrial volumes [110] 	LA/Ao, LA Biplane Vol, LA Biplane Vol Index
	LV Mass (2D) <ul style="list-style-type: none"> • Epi and Endo Area, Apical D 	LV mass [111]	LV Mass, LV Mass Index
Aortic Valve	LVOT (Doppler) <ul style="list-style-type: none"> • LVOT VMax, LVOT VTI, CO HR 	SV and CO [109]	CO, CI, SV, SI
	AS (Doppler) <ul style="list-style-type: none"> • AV VMax, AV VTI, AVA HR, LVET 	<ul style="list-style-type: none"> • Velocity [98] • VTI [107] • HR [98] • Time [98] 	AVA (VTI or VMax), AVA Index (VTI or VMax), AV Velocity Ratio
	AI (Doppler) <ul style="list-style-type: none"> • PHT, VTI 2D <ul style="list-style-type: none"> • AI Vena Con, AVA Planim, LVOT D 	<ul style="list-style-type: none"> • PHT [111] • VTI [107] • Area trace [95] 	—
RV Function	FAC (2D) <ul style="list-style-type: none"> • RV EDA and ESA 	FAC [108]	Right FAC
	TDI (Doppler) <ul style="list-style-type: none"> • RV s' 	TDI [112]	—
	RIMP (Doppler) <ul style="list-style-type: none"> • RVET, IVCT, IVRT 	RIMP [112]	RIMP

Page or list	Measurements (mode)	Procedure	Calculation results
Volume Status	Pre <ul style="list-style-type: none"> • Pre LVOT VTI (Doppler) • Pre-HR (Doppler) • LVOT D (2D) Post (Doppler) <ul style="list-style-type: none"> • Post LVOT VTI, Post HR 	SV and CO [109]	CO % change, SV % change, VTI % change, pre-CO, pre-SV, post-CO, post-SV
	IVC Collapse (2D) <ul style="list-style-type: none"> • IVC Max and Min • RAP 	<ul style="list-style-type: none"> • IVC Collapse [112] • RAP [113] 	IVC Collapse, RVSP
Respiratory Variation (navigate to this page from Volume Status)	Velocity (Doppler) <ul style="list-style-type: none"> • Max and Min LVOT VMax VTI (Doppler) <ul style="list-style-type: none"> • Max and Min LVOT VTI LVOT D (2D)	SV and CO [109]	SV % variation, VTI % variation, VMax % variation, Max SV, Min SV
	Distensibility (2D) <ul style="list-style-type: none"> • IVC Max D and Min D 	IVC Collapse [112]	Distensibility Index (DI)
Right Dimensions	RV Apical (2D) <ul style="list-style-type: none"> • Basal and Mid D, Length, Wall RV Outflow (2D) <ul style="list-style-type: none"> • RV Prox D and RVOT D 	Distance [94]	Pulm SV, Qp:Qs, RA Vol Index
	Right Atrium (2D) <ul style="list-style-type: none"> • RA Vol 	Area trace [95]	—
Dimensions	Diastole (M Mode) <ul style="list-style-type: none"> • RVDd, IVSd, LVDd, LVPWd Systole (M Mode) <ul style="list-style-type: none"> • IVSs, LVDs, LVPWs 	<ul style="list-style-type: none"> • EF/FS [108] • LV mass [111] 	EF, FS, IVS FT, LVPW FT, IVSd/LVPWd, IVSs/LVPWs, LV Mass, LV Mass Index, RVSP
	LA/Ao (M Mode) <ul style="list-style-type: none"> • Ao, LA D 	M Mode distance [108]	LA/Ao
	IVC (M Mode) <ul style="list-style-type: none"> • IVC Max and Min • RAP 	<ul style="list-style-type: none"> • IVC Collapse [112] • RAP [113] 	IVC Collapse
	AVA <ul style="list-style-type: none"> • LVOT D (2D) • AVA HR (Doppler) • VMax (Doppler) <ul style="list-style-type: none"> • LVOT VMax and AV VMax • VTI (Doppler) <ul style="list-style-type: none"> • LVOT VTI and AV VTI 	AVA [113]	AVA (VTI or VMax), AVA Index (VTI or VMax, AV Velocity Ratio)

Page or list	Measurements (mode)	Procedure	Calculation results
	2D • AVA Planim	Area trace [95]	—
Diastology	TDI • Sep e' and a' • Lat e' and a' • Ant e' and Inf e'	TDI [112]	Sep E/e', Lat E/e', Ant E/e', Inf E/e'
	MV (Doppler) • MV E, Decel, A, and Adur • IVRT	• Velocity [98] • Time [98]	MV E/A
	Pulmonary Vein (Doppler) • P Vein S, D, A, and Adur	• Velocity [98] • Time [98]	—
	RVSP (Doppler) • TR VMax and RAP	RVSP [113]	RVSP
	LA Vol • LA Vol A4C and A2C	Atrial volumes [110]	LA Biplane Vol, LA Biplane Vol Index
	Great Vessels	IVC (2D) • IVC Max and Min • RAP	• IVC Collapse [112] • RAP [113]
	Aorta (2D) • Ao Root D, Asc Ao D, LVOT D, and Abd Ao Surgical Aorta (2D) • Ao Ann D, Sinus Val D, STJ D	Distance [94]	—
Qp:Qs	Left • LVOT D (2D) • LVOT VTI (Doppler) Right • RVOT D (2D) • RVOT VTI (Doppler)	Qp:Qs [110]	Qp:Qs, SV, Pulm SV
Mitral Valve	Inflow (Doppler) • MV E and A • MV Decel Time	• Velocity [98] • Slope [99]	MV E/A, Sep E/e', Lat E/e', Ant E/e', Inf E/e'
	MS • MV Ann D (2D) • MV VTI (Doppler) • HR (MVA) (Doppler) • MV PHT (Doppler)	• Distance [94] • VTI [107] • Area trace [95]	MVA (PHT), MVA (VTI)

Page or list	Measurements (mode)	Procedure	Calculation results
	MR • MV dP/dt (CW Doppler) 2D • MVA Planim • MR Vena Con	• dP/dt [113] • Area trace [95]	—
Valves	TV (M Mode) • TAPSE MV (M Mode) • MAPSE, EPSS, D-E Slope, E-F Slope AV (M Mode) • ACS and LVET	• MAPSE/ TAPSE [110] • M Mode distance [108] • Time [98]	—
Tricuspid/ Pulmonic	RVSP (Doppler) • TR VMax and RAP	RVSP [113]	RVSP
	PV (Doppler) • AT, VTI, VMax	• Time [98] • VTI [107] • Velocity [98] • PHT [111]	—
	TV (Doppler) • VTI, E, A, PHT		
HR	HR (M Mode and Doppler)	HR [98]	—

Table 29. Focused cardiac measurements and calculations

Page or list	Measurements (mode)	Procedure	Calculation results
Left Heart	EF (2D and M Mode) • LVDd and LVDs	EF/FS [108]	LV EF, LV FS
	Left FAC (2D) • LV EDA and ESA	FAC [108]	LV FAC
	CO • LVOT D (2D) • LVOT VTI (Doppler) • CO HR (Doppler)	SV and CO [109]	LVOT CO, LVOT CI, LVOT SV, LVOT SI
	• MAPSE (M Mode) • EPSS (M Mode)	• MAPSE/TAPSE [110] • M Mode distance [108]	—
Volume Status	Pre • Pre LVOT VTI (Doppler) • Pre HR (Doppler) • LVOT D (2D) Post (Doppler) • Post LVOT VTI and HR	SV and CO [109]	CO % change, SV % change, VTI % change, pre-Co, pre-SV, post-CO, post-SV

Page or list	Measurements (mode)	Procedure	Calculation results
	IVC Collapse (2D and M Mode) <ul style="list-style-type: none"> • IVC Max D and Min D • RAP 	<ul style="list-style-type: none"> • IVC Collapse [112] • RAP [113] 	IVC Collapse, RVSP
Volume Status > Respiratory Variation	Max <ul style="list-style-type: none"> • LVOT VMax and VTI (Doppler) • LVOT D (2D) Min (Doppler) <ul style="list-style-type: none"> • LVOT VMax and VTI 	SV and CO [109]	SV % variation, VTI % variation, VMax % variation, SV Max, SV Min
Right Heart	Right FAC (2D) <ul style="list-style-type: none"> • RV EDA and ESA 	FAC [108]	Right FAC
	TAPSE (M Mode)	MAPSE/TAPSE [110]	—
	RVSP (Doppler) <ul style="list-style-type: none"> • TR VMax and RAP 	RVSP [113]	RVSP
Great Vessels	IVC Collapse (2D and M Mode) <ul style="list-style-type: none"> • IVC Max and Min • RAP 	<ul style="list-style-type: none"> • IVC Collapse [112] • RAP [113] 	IVC Collapse
	Thoracic Aorta (2D) <ul style="list-style-type: none"> • Ao Root D and Asc Ao D 	Distance [94]	—
Great Vessels > Respiratory Variation	Distensibility (2D and M Mode) <ul style="list-style-type: none"> • IVC Max D and Min D 	IVC Collapse [112]	Distensibility Index (DI)
HR	HR (M Mode and Doppler)	HR [98]	—



NOTE

- Many cardiac calculations require both 2D and Doppler measurements.
- Some measurements are associated as ordered sets. Tap **Next** to activate the next caliper tool.

Measuring Velocity Time Integral (VTI)



WARNING



Moving the baseline, scrolling, or inverting the trace while frozen clears the displayed results.

This measurement calculates other results in addition to VTI including VMax, PG Max, VMean, and PG Mean.





WARNING

Trace only a single heartbeat. The VTI calculation is not valid if measured with more than one heartbeat.



1. On a frozen Doppler spectral trace, tap **Calcs** /  and navigate to the cardiac package on the touchscreen.
2. Tap  and select **Manual Trace** or **Auto Measure** from the drop-down list on a VTI measurement (for example, LVOT VTI).
3. Follow the Doppler manual trace or auto trace procedure to perform the measurement (see [Performing manual trace measurements \[99\]](#) or [Performing automatic trace measurements \[100\]](#)).
4. Tap  to save the results.

Measuring distance in M Mode

You can measure many of the cardiac distance measurements in M Mode.

1. On a frozen M Mode sweep, tap **Calcs** /  and navigate to the cardiac package on the touchscreen.
2. Tap a measurement button (for example, **LAd** under **Dimensions**).
3. Use the touchscreen to position the calipers on the M Mode trace.
4. Tap  to save the results.

Calculating Ejection Fraction (EF) and Fractional Shortening (FS)

1. On a frozen 2D image or M Mode sweep, tap **Calcs** /  and navigate to the cardiac package on the touchscreen.
2. Tap **Left Heart** or **LV Function/EF**.
3. Do the following for LVDd and then for LVDs:
 - a. Tap the measurement button.
 - b. Use the touchscreen to position the calipers.
4. Tap  to save the results.



NOTE

If you are measuring in 2D, use the cine control to find the appropriate frame (see [Viewing frames in the cine buffer \[78\]](#)).

Calculating fractional area change (FAC)

1. On a frozen 2D image, tap **Calcs** /  and navigate to the cardiac package on the touchscreen.

2. Do one of the following:
 - Tap **Left Heart** or **LV Function/EF**.
 - Tap **Right Heart** or **RV Function**.
3. Do the following for EDA and then for ESA:
 1. Tap the measurement button.
 2. Use the calipers to trace the desired area (see [Measuring circumference or area by tracing \[95\]](#)).
4. Tap  to save the results.







NOTE

If you are measuring in 2D, use the cine control to find the appropriate frame (see [Viewing frames in the cine buffer \[78\]](#)).

Calculating Stroke Volume (SV), Stroke Index (SI), Cardiac Output (CO), and Cardiac Index (CI)

These calculations require a measurement in 2D and a measurement in Doppler. SI and CI also require Body Surface Area (BSA).



1. (SI and CI only) Fill in the **Height** and **Weight** fields on the patient form. The BSA is calculated automatically.
2. Measure LVOT diameter:
 - a. On a frozen 2D image, tap **Calcs**  and navigate to the cardiac package on the touchscreen.
 - b. Tap **LVOT** from a measurement list and perform a distance measurement (see [Measuring the distance between two points \[94\]](#)).
 - c. Tap  to save the results.
3. Measure LVOT VTI:
 - a. Scan in Doppler and freeze the image .
 - b. Tap **LVOT VTI** from a measurement list. Follow the Doppler manual trace or auto trace procedure to perform the measurement (see [Performing manual trace measurements \[99\]](#) and [Performing automatic trace measurements \[100\]](#)).
 - c. Tap  to save the results.
4. Measure HR as described in [Measuring heart rate \(Doppler\) \[98\]](#).
5. Tap  to save the results.

Calculating LV volume and EF (Simpson's Rule)





NOTE

To calculate biplane EF, you need to make all four measurements.

1. On a frozen 2D image, tap **Calcs**  and navigate to the cardiac package on the touchscreen.
2. Tap **LV Function/EF**, then tap **A4Cd Vol**, **A4Cs Vol**, **A2Cd Vol**, or **A2Cs Vol** under Apical EF.
3. Do the following for each measurement:
 - a. Use the touchscreen to position the caliper at the annulus.
 - b. Trace the ventricular cavity starting at the mitral annulus and ending at the other annulus.
 - c. Adjust ventricle length as needed.
4. Tap  to save the results.





Measuring Tricuspid or Mitral Annular Plane Systolic Excursion (TAPSE or MAPSE)

TAPSE is used to evaluate right ventricular systolic function. MAPSE is a similar measurement used to assess left ventricular function.

1. On a frozen M Mode sweep, tap **Calcs**  and navigate to the cardiac package on the touchscreen.
2. Tap **Right Heart**, **Left Heart**, or **Function**
3. Tap **MAPSE** or **TAPSE**.
A right-angled caliper pair appears.
4. Use the touchscreen to position the calipers
5. Tap  to save the results.

Calculating Qp:Qs

The Qp:Qs calculation requires two measurements in 2D and two measurements in Doppler.

1. On a frozen 2D image, tap **Calcs**  and navigate to the cardiac package on the touchscreen.
2. Do the following to measure the LVOT D and again to measure the RVOT D:
 - a. Tap **Qp:Qs**, then tap **LVOT D** under Left or **RVOT D** under Right.
 - b. Use the touchscreen to position the calipers
 - c. Tap  to save the results.
3. Do the following to measure the LVOT VTI and again to measure the RVOT VTI:
 - a. Scan in Doppler and freeze the image .
 - b. Tap **Qp:Qs**, then tap **LVOT VTI** under Left or **RVOT VTI** under Right.
 - c. Follow the Doppler manual trace or auto trace procedure to perform the measurement (see [Performing manual trace measurements \[99\]](#) and [Performing automatic trace measurements \[100\]](#)).
 - d. Tap  to save the results.

Calculating atrial volumes (Simpson's Rule)

1. On a frozen 2D image, tap **Calcs**  and navigate to the cardiac package on the touchscreen.
2. Tap **Left Dimensions**, **Diastology**, or **Right Dimensions**.
3. Tap **LA Vol A4C**, **LA Vol A2C**, or **RA Vol**.
4. Do the following for each measurement:
 - a. Use the touchscreen to position the caliper at the annulus.

- b. Trace the atrial cavity, ending at the other annulus (see [Measuring circumference or area by tracing \[95\]](#)).



NOTE

The recommended method is to trace from annulus to annulus and allow the system to automatically close the trace.

- c. You can adjust the atrial length by dragging the cursor.
5. Tap  to save the results.





NOTE

To calculate atrial volume indexes, BSA is required.



Calculating LV mass

You can calculate LV mass in 2D or M Mode.



1. On a frozen 2D image or M Mode sweep, tap **Calcs**/ and navigate to the cardiac package on the touchscreen.
2. To calculate LV mass in 2D:
 - a. Tap **Left Dimensions**.
 - b. Trace the desired area for **Epi Area** and then for **Endo Area** (see [Measuring circumference or area by tracing \[95\]](#)).
 - c. Tap **Apical D** and use the calipers to measure the ventricular length (see [Measuring the distance between two points \[94\]](#)).
 - d. Tap  to save the results.
3. To calculate LV mass in M Mode:
 - a. Tap **Dimensions**.
 - b. Take an M Mode distance measurement for **LVDd**, **LVPWd**, and **IVSd**.
 - c. Tap  to save the results.

Measuring Pressure Half Time (PHT)



You can use this measurement to calculate Mitral Valve Area (MVA).

1. On a frozen Doppler spectral trace, tap **Calcs** /  and navigate to the cardiac package on the touchscreen.
2. From an analysis package page, tap a **PHT** measurement (for example, TV PHT).
3. Use the touchscreen to position the first caliper at the peak.
4. Use the touchscreen to position the second caliper.
 - For MV PHT, drag the caliper along the E wave deceleration slope.
 - For AI PHT, drag the caliper to the end diastole.
5. Tap  to save the results.



Measuring a Tissue Doppler Imaging (TDI) waveform

1. Ensure that TDI is on (see [Doppler imaging controls \[73\]](#)).
2. On a frozen Doppler spectral trace, tap **Calcs** /  and navigate to the cardiac package on the touchscreen.
3. Do the following for each measurement you want to take:
 - a. Under **Diastology** or **RV Function**, tap **TDI** and then tap the measurement name.
 - b. Perform a velocity measurement (see [Measuring velocity \[98\]](#)).
4. Tap  to save the results.

Calculating Right Ventricular Index of Myocardial Performance (RIMP)

1. On a frozen Doppler spectral trace, tap **Calcs** /  and navigate to the cardiac package on the touchscreen.
2. Tap **RV Function**.
3. Measure **IVRT**:
 - a. Use the touchscreen to position the first caliper at the aortic valve closure.
 - b. Use the touchscreen to position the second caliper at the onset of mitral inflow.
4. Measure **ICRT**:
 - a. Use the touchscreen to position the first caliper at the tricuspid valve closure.
 - b. Use the touchscreen to position the second caliper at the pulmonic valve opening.
5. Measure **RVET**:
 - a. Use the touchscreen to position the first caliper at the pulmonic valve opening.
 - b. Use the touchscreen to position the second caliper at the aortic valve closure.
6. Tap  to save the results.

Calculating Inferior Vena Cava (IVC) Collapse and Distensibility Index



1. On a frozen 2D image or M Mode sweep, tap **Calcs** /  and navigate to the cardiac package on the touchscreen.
2. Tap **Great Vessels, Dimensions, or Volume Status**. (You may also navigate to **Respiratory Variation**).
3. Measure the maximum diameter:
 - a. Cine the image to show maximum expansion (see [Viewing frames in the cine buffer \[78\]](#)).
 - b. In the measurement list, tap **IVC Max D**.
 - c. Use the calipers to measure the diameter (see [Measuring the distance between two points \[94\]](#)).
 - d. Tap  to save the results.
4. Measure the minimum diameter:
 - a. Cine the image to show minimum contraction.
 - b. In the measurement list, tap **IVC Min D**.
 - c. Use the calipers to measure the diameter.
 - d. Tap  to save the results.

Selecting the RA pressure (RAP)

1. On a frozen image, tap **Calcs** /  and navigate to the cardiac package on the touchscreen.
2. On an analysis package page (for example, Right Heart), tap **RAP**.
3. Select the desired value from the RA list.



Calculating Aortic Valve Area (AVA)

The AVA calculation requires a measurement in 2D and two measurements in Doppler.



1. On a frozen 2D image, tap **Calcs** /  and navigate to the cardiac package on the touchscreen.
2. Tap the **LVOT D** measurement button under **Aortic Valve** or **AVA**.
3. Use the touchscreen to position the calipers
4. Tap  to save the results.
5. On a frozen Doppler spectral trace, measure either by VMax or VTI.
 - by VMax - For both **LVOT VMax** and **AV VMax**, drag the caliper to the peak velocity waveform.
 - by VTI - For both **LVOT VTI** and **AV VTI**, trace the Doppler waveform.
6. Tap  to save the results.

Calculating delta pressure/delta time (dP/dt)

To perform the dP/dt measurements, the CW Doppler scale must include velocities of 300 cm/s or greater on the negative side of the baseline.

1. Ensure that CW Doppler is on (see [Doppler imaging controls \[73\]](#)).
2. On a frozen Doppler spectral trace, tap **Calcs** /  and navigate to the cardiac package on the touchscreen.
3. Tap **Mitral Valve**, then tap **MV dP/dt** under MR.
A horizontal dotted line with an active caliper appears at 100 cm/s.
4. Use the touchscreen to drag the first caliper along the waveform at 100 cm/s.
A second horizontal dotted line with an active caliper appears at 300 cm/s.
5. Use the touchscreen to drag the second caliper along the waveform at 300 cm/s.
6. Tap  to save the results.

Calculating the Right Ventricular Systolic Pressure (RVSP)

1. On a frozen Doppler spectral trace, tap **Calcs** /  and navigate to the cardiac package on the touchscreen.
2. Tap **TR VMax** under **RVSP**.
3. Use the touchscreen to position the caliper
4. Tap **RAP** and select a value from the drop-down list.
5. Tap  to save the results.

Carotid measurements and calculations

Carotid measurements and calculations are listed in the following table. You can also measure volume (see [Measuring volume \[96\]](#)) and volume flow (see [Calculating volume flow \[101\]](#)). For an explanation of terms and abbreviations, see the [Glossary \[264\]](#).

Table 30. Carotid measurements and calculations

Page or list	Measurements (mode)	Procedure	Calculation results
• Rt CCA Flow 1	Rt and Lt CCA D (2D)	Distance [94]	• CCA Flow
• Lt CCA Flow 1	Rt and Lt VTI (Doppler)	VTI [107]	• VTI
• Rt CCA Flow 2			• HR
• Lt CCA Flow 2			



WARNING

Trace only a single heartbeat. The VTI calculation is not valid if measured with more than one heartbeat.



WARNING

Diagnostic conclusions about blood flow based on VTI alone can lead to improper treatment. Accurate blood flow volume calculations require both the vessel area and velocity of blood flow. In addition, accurate blood flow velocity is dependent on a correct Doppler angle of incidence.

CVR measurements and calculations

CVR (catheter to vessel ratio) measurements are listed in the following table along with calculation results that appear on the clinical monitor and in the report. For an explanation of terms and abbreviations, see the [Glossary \[264\]](#).



The CVR calculation is available in the following analysis packages: Arterial, Nerve, PIV, Vascular Access, Venous.

Before performing a calculation, make sure that you have selected the appropriate formula. The system will calculate the vessel and catheter size as a diameter or area depending on the chosen author's formula. See [CVR calculations settings \[51\]](#).

Page or list	Measurements	Procedure	Calculation results
CVR - French	• Vessel diameter • French	Distance [94]	CVR (Fr)
CVR - Gauge	• Vessel diameter • Gauge	Distance [94]	CVR (Gauge)

Calculating CVR (catheter to vessel ratio)

1. Select the CVR author that you intend to use (see [Selecting authors for obstetrical calculations \[51\]](#)).

2. On a frozen 2D image, tap **Calcs**/ and navigate to the CVR calculations package on the touchscreen.
3. Measure the vessel diameter:
 - a. In the measurement list under CVR - French or CVR - Gauge, tap **Vessel D**.
 - b. Use the calipers to measure the diameter (see [Measuring the distance between two points \[94\]](#)). The clinical monitor will display the CVR calculations for common Gauges or French catheter sizes.
 - c. To save the CVR for a specific catheter, select the **Gauge** or **French** catheter size from their respective drop-down.
 - d. Tap  to save the results.

Gynecological measurements and calculations



The Gynecological calculations include 2D measurements for uterus, ovaries, and follicles.

Table 31. Gynecological measurements and calculations

Page or list	Measurements (2D mode)	Procedure	Calculation results
Uterus	Uterus L, H, and W	<ul style="list-style-type: none"> • Distance [94] • Volume [96] 	Uterus Vol
—	Endometrium	Distance [94]	—
Right Ovary	Rt Ovary L, H, and W	<ul style="list-style-type: none"> • Distance [94] • Volume [96] 	Rt Ovary Vol
Left Ovary	Lt Ovary L, H, and W	<ul style="list-style-type: none"> • Distance [94] • Volume [96] 	Lt Ovary Vol
Fertility > Follicles	Right and Left Foll 1-10	Distance [94]	—

Measuring uterus

You can measure uterus length (L), width (W), height (H), and endometrial thickness. If you measure length, width, and height, the system also calculates the volume (see [Measuring volume \[96\]](#)).

1. On a frozen 2D image, tap **Calcs**/ and navigate to the gynecology analysis package on the touchscreen (if you are imaging using the gynecology exam type, this package is preselected).
2. Under **Uterus Volume**, tap a measurement button.
3. Take a distance measurement (see [Measuring the distance between two points \[94\]](#)).
4. Tap  to save the results.

Measuring ovaries



You can measure ovary length (L), width (W) and height (H). If you measure length, width, and height, the system also calculates the volume (see [Measuring volume \[96\]](#)).

1. On a frozen 2D image, tap **Calcs**/ and navigate to the gynecology analysis package on the touchscreen.
2. Do the following for each measurement you want to take:
 - a. Tap the measurement button under **Right Ovary** or **Left Ovary**.
 - b. Take a distance measurement (see [Measuring the distance between two points \[94\]](#)).

- c. Tap  to save the results.

Measuring follicles

You can save up to three distance (D) measurements per follicle.

1. On a frozen 2D image, tap **Calcs**/ and navigate to the gynecology analysis package on the touchscreen.
2. Tap **Follicles**.
3. Do the following for each measurement you want to take:
 - a. Tap the follicle number for the follicle you are measuring, such as **Rt Foll 1**.
 - b. Take a distance measurement (see [Measuring the distance between two points \[94\]](#)).
 - c. Tap the same follicle to measure a second dimension of the same follicle or tap  to save just the first measurement.
 - d. Follow steps b and c to take a third measurement.
 - e. Tap  to save the results.

Obstetrics measurements and calculations



WARNING

- Make sure that you have selected the obstetrics exam type and the OB author for the obstetrical calculations you intend to use. See [Obstetrics calculations settings \[50\]](#).
- To avoid incorrect obstetrics calculations, verify with a local clock and calendar that the system's date and time settings are correct before each use of the system.
- To avoid misdiagnosis or harming the patient outcome, make sure you end the previous study before starting a new patient study and performing calculations. Otherwise, the previous patient's data will be combined with the current patient.

Estimated Fetal Weight (EFW) can be calculated using biparietal diameter (BPD), head circumference (HC), abdominal circumference (AC), and femur length (FL) values that are within range. If the BPD and HC values are out of range or are not performed, the system calculates the EFW using only the AC and FL values.

Obstetric measurements are listed in the following tables along with calculation results that appear on the clinical monitor and in the report. The ultrasound system has two obstetric analysis packages; Early OB and OB. For an explanation of terms and abbreviations, see the [Glossary \[264\]](#).

Table 32. OB measurements and calculations

Page or list	Measurements (mode)	Procedure	Calculation results
Biometry	<ul style="list-style-type: none"> • BPD (2D) • HC (2D) • AC (2D) • FL (2D) 	<ul style="list-style-type: none"> • Distance [94] • Ellipse [95] • Ellipse [95] • Distance [94] 	<ul style="list-style-type: none"> • HC/AC • FL/AC • FL/BPD • FL/HC • EFW • EFW Percentile • EDD by LMP^a • EDD by AUA • GA by LMP^a • GA by EDD^b • AUA • CI • CI (HC)
More Biometry	Head (2D) <ul style="list-style-type: none"> • OFD • OOD • IOD Brain (2D) <ul style="list-style-type: none"> • Lat Vent • CM • Cerebellum 	Distance [94]	<ul style="list-style-type: none"> • EDD by AUA • AUA • CI
BPP	<ul style="list-style-type: none"> • Breathing • Movement • Tone • Fluid • NST 	—	BPP
AFI	<ul style="list-style-type: none"> • Q1 (2D) • Q2 (2D) • Q3 (2D) • Q4 (2D) 	Distance [94]	AFI
Maternal	Cervix (2D)	Curved distance [95]	—
—	FHR (M Mode and Doppler)	<ul style="list-style-type: none"> • FHR [118] • HR [98] 	—
MCA	MCA Trace (Doppler)	Manual [99] or auto [100] trace	—
Umbilical Art	<ul style="list-style-type: none"> • UmbA S/D Ratio (Doppler) • UmbA Trace (Doppler) 	<ul style="list-style-type: none"> • Velocity pair [98] • Manual [99] or auto [100] trace 	—

^aTo make this calculation, you must enter LMP in the patient form.



^bTo make this calculation, you must enter EDD in the patient form.

Table 33. Early OB measurements and calculations



Page or list	Measurements (mode)	Procedure	Calculation results
Fetus	<ul style="list-style-type: none"> • CRL (2D) • BPD (2D) • NT (2D) 	Distance [94]	<ul style="list-style-type: none"> • EDD by LMP^a • EDD by AUA • GA by LMP^a • GA by EDD^b • AUA
Mean Gest Sac GA	Gest Sac 1, 2, and 3 (2D)	Distance [94]	<ul style="list-style-type: none"> • Mean Gest Sac D • GA • AUA
Right Ovary	Rt Ovary L, H, and W (2D)	Volume [96]	Rt Ovary Vol
Left Ovary	Lt Ovary L, H, and W (2D)	Volume [96]	Lt Ovary Vol
Yolk Sac	Yolk Sac (2D)	Distance [94]	—
Maternal	<ul style="list-style-type: none"> • Cervix (2D) • Myometrial Mantle (2D) 	<ul style="list-style-type: none"> • Area trace [95] • Distance [94] 	—
—	FHR (M Mode)	FHR [118]	—

Performing an OB measurement or calculation (2D)

For each 2D obstetrical measurement (except AFI), the system saves up to three individual measurements and their average.

1. Make sure that an obstetrics exam type is selected.
2. In the patient form, select and enter **LMP** or **EDD** under **Obstetrics**. Specify multiples, if applicable.
3. On a frozen 2D image, tap **Calcs**/ and navigate to an obstetrics analysis package on the touchscreen (if you are imaging using an obstetric exam type, this package is preselected).
4. For multiples, tap the appropriate fetus (A, B, C, or D).
5. Tap a measurement button and perform the measurement according to its measurement type.
6. If doing a biophysical profile (BPP) measurement, select a value from the drop-down list.
7. Tap  to save the results.

Measuring fetal heart rate (M Mode)



1. Make sure that an obstetrics exam type is selected.
2. In the patient form, select the number of multiples, if applicable.
3. On a frozen M Mode sweep, tap **Calcs**/ and navigate to an obstetrics analysis package on the touchscreen.
4. For multiples, tap the appropriate fetus (A, B, C, or D).
5. Tap the **FHR** measurement button.
6. Take a heart rate measurement (see [Measuring heart rate \(M Mode\) \[97\]](#)).
7. Tap  to save the results.

Calculating the Middle Cerebral Artery (MCA) trace, the Umbilical Artery (UmbA) trace, or the UmbA S/D ratio







WARNING

If calipers are positioned imprecisely, the calculation result is inaccurate.

1. Make sure that an obstetrics exam type is selected.
2. In the patient form, select the number of multiples, if applicable.
3. On a frozen Doppler spectral trace, tap **Calcs/**  and navigate to an obstetrics analysis package on the touchscreen.
4. For multiples, tap the appropriate fetus (A, B, C, or D).
5. Do the following for each measurement you want to take:
 - a. Tap the measurement button under **MCA** or **Umbilical Art.**
 - b. Take the measurement:
 - For the MCA and UmbA traces, tap  to select between manual or auto trace, and follow the [Performing manual trace measurements \[99\]](#) or [Performing automatic trace measurements \[100\]](#) procedure.
 - For the UmbA S/D ratio, drag the caliper to the peak systole on the waveform. Select the second caliper and drag it to the end diastole.
6. Tap  to save the results.

Measuring gestational sacs

The gestational age (GA) and mean sac diameter only appear if you have made all three measurements. You can take each measurement multiple times, but only the latest measurement is saved.

1. Make sure that an obstetrics exam type is selected.
2. On a frozen 2D image, tap **Calcs/**  and navigate to the **Early OB** obstetrics analysis package on the touchscreen.
3. For multiples, tap the appropriate fetus (A, B, C, or D).
4. Tap **Mean Gest Sac GA**.
5. Tap **Gest Sac 1** and perform a distance measurement (see [Measuring the distance between two points \[94\]](#)).
6. Tap **Gest Sac 2** and perform a distance measurement.
7. Tap  to save the results.
8. To obtain the third measurement, acquire and freeze a new image, tap **Calcs/** , and then tap **Gest Sac 3**.
9. Tap  to save the results.



MSK measurements and calculations

The following table shows the measurements available for musculoskeletal (MSK) calculations. Calculation results appear on the clinical monitor and in the report.



Table 34. MSK measurements and calculations

Page or list	Measurements (2D mode)	Procedure	Calculation results
Right Hip Angle	<ul style="list-style-type: none">Rt BaselineRt Roof LineRt Inclination Line	Hip angle [120]	<ul style="list-style-type: none">Rt Hip αRt Hip β
Right d:D Ratio	<ul style="list-style-type: none">Rt Femoral HeadRt Baseline	Hip ratio [120]	Rt Hip d:D Ratio
Left Hip Angle	<ul style="list-style-type: none">Lt BaselineLt Roof LineLt Inclination Line	Hip angle [120]	<ul style="list-style-type: none">Lt Hip αLt Hip β
Left d:D Ratio	<ul style="list-style-type: none">Lt Femoral HeadLt Baseline	Hip ratio [120]	Lt Hip d:D Ratio

Calculating hip angle

- On a frozen 2D image, tap **Calcs**/ and navigate to the MSK analysis package on the touchscreen (if you are imaging using the MSK exam type, this package is preselected).
- Do the following under **Right Hip Angle** and again under **Left Hip Angle**.
 - Tap **Baseline**.
A baseline with calipers appears.
 - Use the touchscreen to position the calipers.
 - Tap **Next** or tap **Roof Line**.
 - Use the touchscreen to position the calipers.
 - Tap **Next** or tap **Inclination Line**.
 - Use the touchscreen to position the calipers.
 - Tap  to save the results.

Calculating hip ratio

- On a frozen 2D image, tap **Calcs**/ and navigate to the MSK analysis package on the touchscreen.
- Do the following under **Right d:D Ratio** and again under **Left d:D Ratio**.
 - Tap **Femoral Head**.
An ellipse appears with two calipers.
 - Use the touchscreen to switch between moving and resizing the ellipse.
 - Tap **Next** or tap **Baseline**.
The baseline calipers appear.
 - Use the touchscreen to position the calipers.
 - Tap  to save the results.

Managing Patient Data

Sonosite ST offers tools for managing patient data, including study management, reports, and worksheets. Studies organize and consolidate all of the data associated with an exam. Reports provide a summary of study information, including the study date and time, patient information, exam type, worksheets, and any measurements and calculations that were made.



Managing studies

Using the patient list

The patient list module lists the current, active study, as well as completed and saved studies. You can sort the list, view and delete studies, and append images and video clips to an existing study.

From the list, you can also archive studies to a DICOM archive server or export studies to a USB storage device.



The patient list contains the following information:

- **Patient name**
- **MRN** Medical Record Number
- **Exam type** (for example, cardiac)
- **Date/time** The date and time of the study
- **Performing** The user who performed the study
-  The number of video clips and images saved with the study
- **Status** The archive status of the study
-  The export status of the study

Displaying and sorting the patient list

- To display the patient list, tap **Patient List** on the touchscreen, at the bottom of the patient form or report form, or from the menu .
- To sort the patient list, tap the column heading that you want to sort by, and tap it again to sort in reverse order.
By default, the list is sorted by date and time, with the most recent patient listed first.

Searching the patient list

1. Tap the **Search**  field at the top of the page.
2. Type in the following search terms in the search field:
 - Patient name (first, last, middle)
 - MRN
 - Performing clinician nameMatching results appear in the list.
3. To delete terms, tap the  on the on-screen keyboard.

Selecting studies

Do one of the following:

- In the list, tap one or more studies.
- To select all studies, tap **Select All**. To deselect all studies, tap **Deselect All**.

Selected studies display a check mark and are highlighted in blue.

Deleting a study

1. In the list, select a study by tapping it.
2. Tap **Delete**.
3. Tap **Yes** to confirm the deletion.

Opening and reviewing a study

Do one of the following:

- Double-tap a study in the list to open the review page.
- Tap a study to select it, tap **View** at the bottom of the page, and then tap **Review Images** or **Report**.

Appending images and clips to a study

You can use the Append button to start a new study that has the same patient information as an ended study. Depending on your archiver, the two studies appear as one study when exported or archived.

1. In the list, select the study by tapping it.
2. Tap **Append**.
3. If configured, select or deselect one or more archivers.
Archivers that have previously been configured as default are already selected (see [Associating devices with locations \[49\]](#)).

A new patient form appears. The form has the same information as the study you selected.









Archiving studies

If you have configured the system for DICOM transfer (see [Configuring the system for DICOM transfer \[43\]](#)), the system archives a study's images, video clips, and patient report to the selected DICOM devices when the study ends. To archive video clips and structured reports, make sure to select the appropriate check boxes on the **Archiver** configuration page. Archiving occurs either during the study or at the end of the study, depending on the settings you have chosen in the **Transfer Images** setting on the **Location** configuration page. You can also manually archive studies to DICOM devices from the patient list.

The system continues to send studies to DICOM when it is in sleep mode.

Verifying that studies transferred

- Tap **Patient List**.
The **Status** column shows the status of the transfer.
 -  Archiving is pending.

-  Archiving is in progress.
-  The study is successfully archived.
-  The study is paused because of connectivity issues. The system retries the transfer after a configured delay time (see [Location configuration fields \[45\]](#)).
-  The study is archive suspended. Network connection settings may be wrong or there may be a server problem. The study needs to be manually archived (see [Manually archiving studies \[123\]](#)).
-  Storage commit is successful.
-  Storage commit is suspended. Network connection settings may be wrong or there may be a server problem.
-  and  DICOM configuration has changed so archive and storage commit status could be incorrect. The study might need to be transferred again.
- No icon. The study is locally stored and not archived.



Displaying archive status information

You can display information about a study, including transfer details.

1. Tap **Patient List**.
2. Select the desired study in the list by tapping it.
3. Tap **View**.
4. Tap **Status**.

For each configured archive, the following information displays: Images/clips that have successfully been archived, storage committed, MPSS, suspended or in progress. If progress is suspended, you can resend the data.

Manually archiving studies

1. Verify the following:
 - The DICOM and network settings.
 - If the system is connected to a network via an Ethernet connection, the Ethernet connected icon  appears in the system status area on the monitor.
 - For a wireless connection, the wireless connected icon  appears in the system status area on the monitor.
2. Tap **Patient List**.
3. In the list, select one or more studies by tapping them.
4. Tap **Send to**, then select **Archive**.
5. Choose one or more archives from the Archive dialog, and tap **Send to**.

Discontinuing MPPS for a study

You can discontinue MPPS for a study before completing the study.

1. On the patient form, tap **Discontinue**.
A dialog displays.

2. If configured, select or deselect one or more archivers.
Archivers that have previously been configured as default are already selected (see [Associating devices with locations \[49\]](#)).
3. Do one of the following:
 - Tap **Yes** to discontinue MPPS for the study.
 - Tap **Cancel** to return to the patient form.

Exporting studies

You can export studies to a USB storage device for archiving. Make sure you archive patient studies regularly.





CAUTION

Patient information might be a protected class of patient data subject to country-specific security guidelines. If you choose to include patient information when exporting or printing images and clips, be sure your information storage and handling practices comply with country-specific security guidelines.

You can export patient studies if they are ended and if the system administrator has not disabled USB export. Studies include images, video clips, and the patient report.

Exporting patient studies manually to a USB storage device

1. Specify the file format for exported images (see [USB settings \[58\]](#)).
2. Tap **Patient List**.
3. Connect a USB storage device (see [Inserting and removing USB devices \[19\]](#)).
4. In the study list, select one or more studies by tapping them.
5. Tap **Send to**, then select **USB**.
A list of USB storage devices appears.
6. Select the USB storage device from the list.
7. Enter a file name.
8. If you want to show patient information, select **Include patient information on images and video clips**.
By default, patient information such as names and IDs are removed from images and clips before exporting to protect patient confidentiality.
9. Tap **Export**.

The files are finished exporting approximately five seconds after the USB animation  stops. Removing the USB storage device or turning off the system while exporting may cause exported files to be corrupted or incomplete. To stop in-progress exporting, tap **Cancel**. The  column of the patient list indicates whether the system has exported the study.

Managing internal storage

After archiving or exporting patient data, regularly delete data from the system. Low internal storage can impact system performance. The save available icon in the system status area shows the percentage of space available in internal storage. If storage is full, the system displays a .

If your system administrator has enabled an internal storage alert (see [Receiving storage alerts \[37\]](#)), the system alerts you that internal storage is low and prompts you to delete archived or storage committed patient studies.

Data can be deleted from the system in the following ways:

- Your system administrator can configure the system to auto-delete all studies or studies that have been transferred to your DICOM server (see [Configuring auto delete settings \[37\]](#)).
- Manually delete studies from the patient list (see [Deleting a study \[122\]](#)).

Managing reports and worksheets

Twenty-six default exam-specific worksheets are available on the system based on ACEP guidelines. Only one worksheet is supported for each study. The report includes the information provided in these worksheets, including any exam-specific measurements and calculations, and patient data. You can continue to add data to the report before you end the study.

Using worksheets

Tap **Report & Worksheet**. The workspace displays with the default Worksheet tab open.

Selecting and filling out a worksheet

1. In the Worksheet tab, tap the  in the **Select a worksheet** drop-down list box to view the available worksheets.
2. Select a worksheet from the list.
Worksheet-specific fields appear.
3. Fill in the exam overview and worksheet fields with the desired information.
Your changes are saved automatically.
4. To clear the worksheet fields, tap **Reset** and confirm the reset.

Custom worksheets

The ultrasound system supports custom worksheets created or edited using an ultrasound workflow application, such as Sonosite Synchronicity. Integration with Telexy Qpath is also possible using Qview, a web browser application which needs an active network connection.

When using the Sonosite Synchronicity Workflow Manager, you can import up to thirty custom worksheets from your server to your system, fill out and sign the worksheets on the system, and transfer the remote worksheet data back to the server. Any worksheet data that you enter can be transferred to the DICOM archiver that has been configured to work with your workflow application.

Both Sonosite Synchronicity custom worksheets and Qview access must be configured by a system administrator (see [Configuring remote worksheet access \[38\]](#)).



NOTE

Downloading custom worksheets from the Sonosite Synchronicity server replaces the default worksheets on the system. The same set of default non-customizable worksheets continue to be available from the Sonosite Synchronicity Workflow Manager server.

Accessing and completing a custom Sonosite Synchronicity worksheet

1. In the Worksheet tab, tap the  in the **Select a worksheet** drop-down list box to view the available worksheets (including custom worksheets).
2. Select a worksheet from the list.
3. Fill in the worksheet fields with the desired information.
4. Select whether to submit the worksheet to the EMR.
5. To sign a worksheet, tap **Signature** at the bottom of the worksheet tab.



NOTE

To be able to sign a custom worksheet, the performing clinician must be filled out under **Provider** in the patient information form.

6. To make further changes to the worksheet, tap **Remove Signature**.

Accessing and completing a Qpath worksheet

1. Tap **Patient List** or **Report & Worksheet**.
The location of the Qpath button depends on the setting selected by your administrator. Use the button on the **Report & Worksheet** page only if **Transfer images** in your DICOM settings has been set to **During the exam**.



NOTE

At least one image, video clip, or report from the study must be archived to Qpath before accessing Qview.

2. Tap **Qpath** at the bottom of the page.
A Qview browser window or login screen opens.
3. If necessary, enter your Qpath username and password in the login screen.
4. While in Qview, you can fill out the worksheet, sign it, and save it.

Editing a report

You can edit the report only while the study is active.

Displaying the report preview

1. Tap **Report & Worksheet**.
The workspace displays with the Worksheet tab open.
2. To view the report, tap the **Report** tab.
Scroll down to view the entire report.

Modifying calculations in the report

You can modify certain calculations if you have taken multiple measurements.

1. Tap **Report & Worksheet**.
The workspace displays with the default worksheet tab open.
2. To view calculations, tap the **Calcs** tab.
3. Select the measurement you would like to base your calculations on from the drop down menu: **Last**, **Mean**, **Max**, and **Min**.

Deleting calculation values from the report

1. Tap **Report & Worksheet**.
The workspace displays with the default worksheet tab open.
2. To view calculations, tap the **Calcs** tab.
3. Select the value, and then tap **Delete**.

Deleting some measurements also deletes related measurements. Deleted measurements are not included in the summary information.

Saving the report as an image

1. Tap **Report & Worksheet**.
2. Tap the **Report** tab.
3. Tap **Save As Images**.

You can print the report as an image. See [Printing images \[89\]](#)

Obstetrics reports

Like all other reports, the obstetrics report consists of worksheet data, calculations, and patient information.

If you need a report for multiples, make sure to fill out the number of multiples in the patient form before completing any calculations.

Generating an obstetrics report

1. Under **Obstetrics** in the patient form, fill in patient information including the number of multiples, if applicable.
2. Perform OB measurements including biophysical profile values (see [Obstetrics measurements and calculations \[116\]](#)).
3. Select an OB worksheet and fill out the anatomy checklist (see [Selecting and filling out a worksheet \[125\]](#)).

Displaying reports after the study has ended







When you end a study, the system saves the patient report with all measurements and calculations performed during the study.

1. Tap **Patient List**.
2. In the study list, select the study by tapping it.
3. Tap **View**.
4. Tap **Report**.
The system displays the read-only report.

Reviewing images, clips, and measurements









You can review your images and video clips after you have taken them, along with any displayed measurements. You can also review measurements and calculations saved to the report from the Report & Worksheet page.

1. Do one of the following:

- To review images and clips from the current study, open the review page by tapping thumbnail images and clips or tapping **Review Images**. You can also tap **Review Images** from the Report & Worksheet page.
 - To review images and clips from a completed study, tap **Patient List** at the bottom of the patient form or report form, or from the menu . Open the review page by double-tapping a study from the list or selecting the study and tapping **View** then **Review Images**.
 - To view measurements and calculations saved to the report, tap **Worksheet** from the review page, or tap **Report & Worksheet** and open the **Calcs** tab.
2. Tap an image or clip on the review page to view it on the clinical monitor.
 3. To view the previous or next page of images and clips, tap  or .
 4. (Video clips only) Do any of the following:
 - To play the video clip, tap the play button .
 - To pause the video clip, tap the pause button .
 - To select a playback speed, tap **1x**, **1/2x**, or **1/4x**.
 - To move backward or forward one frame at a time, tap  or .
 5. To delete an image or video clip, select the image or video clip's check box, and then tap **Delete**.
 6. To exit the review, tap **Exit Review**.

Labeling and measuring during review

The Label and Measure in Review (LMiR) feature provides the ability to edit or add annotations, arrows, pictographs, basic measurements and calculations to saved images during an ongoing or ended study. If you are performing measurements on a saved image from the current study, the measurements are added to the current patient report. If the measurements are performed on a saved image from an already completed study, an addendum is added to the report. LMiR is compatible with all transducers and imaging modes.

1. Open the review page for an open or completed study as described in the preceding section.
2. Tap a thumbnail image or video clip.
To view the previous or next image or video clip, tap  or .
3. To edit or add labels, tap **ABC** or tap **Edit** on the review page. If you are editing a clip, tap the pause button, and then use  and  to find the frame you want.
 - To add or edit a text label, see [Adding, moving, and editing a text label \[87\]](#).
 - To add an arrow, see [Adding arrows \[88\]](#).
 - To add a pictograph, see [Adding pictographs \[88\]](#).
 - To delete a label, see [Deleting labels \[89\]](#).
4. To add measurements and calculations, tap **Caliper**/ to select basic measurements or tap **Calcs**/ to select measurements that are saved to the report. You can also tap **Edit** on the review page. If you are editing a clip, tap pause, and then use  and  to find the frame you want.
 - To make a measurement, see the procedures for specific measurements and calculations described in [Measurements and Calculations \[92\]](#).
 - To delete or edit a measurement, see [Deleting a measurement \[93\]](#) and [Editing a new measurement \[94\]](#).

5. To save your changes, tap .
A new image is added to the study along with any new labels, measurements, and calculations. For completed studies, the new images display a pencil icon.
6. Do any of the following:
 - To return to the review page, tap **Back to Review**.
 - To return to scanning, press **2D** or tap **END EDITING**. If you have been working on a completed study, that study closes and any new data is saved in an addendum to the report.
 - If you have been working on a completed study and wanted to return to the patient list, tap **Back to Patient List**.



NOTE

Saved images and clips that contain edits made after the study has ended display a pencil icon.

Measurement References

This section provides information about measurement accuracy, publications, and terminology.

Measurement accuracy

The measurements from the system are of a physical property such as distance for evaluation by the clinician. The accuracy values require that you can place the calipers over one pixel. The values do not include acoustic anomalies of the body.

The 2D linear distance measurement results are displayed in centimeters or millimeters. The decimal place value depends on the measurement.

The linear distance measurement components have the accuracy and range shown in the following tables.

Sources of measurement errors

Table 35. 2D measurement and calculation accuracy and range

2D measurement	System tolerance ^a	Accuracy by:	Test method	Range (cm)
Axial distance	$\leq \pm (2\% \text{ of measurement} + 1\% \text{ full scale screen depth})$	Acquisition	Phantom ^b	0–35 cm
Lateral distance	$\leq \pm (2\% \text{ of measurement} + 1\% \text{ full scale screen depth})$	Acquisition	Phantom ^b	0–48 cm
Diagonal distance	$\leq \pm (2\% \text{ of measurement} + 1\% \text{ full scale screen depth})$	Acquisition	Phantom ^b	0–48 cm
Area	$\leq \pm (4\% + 0.2\% \text{ of the current image depth divided by the smallest axis dimension})$ of the measurement	Acquisition	Phantom ^c	0.0–1800 cm ²
Circumference	$\leq \pm (2\% \text{ of measurement} + 0.36\% \text{ of current image depth})$	Acquisition	Phantom ^b	0–150 cm

^aFull scale for distance implies the maximum depth of the image.

^bFUJIFILM Sonosite special test equipment was used.

^cA Gammex 403 model phantom was used.

Table 36. M Mode measurement and calculation accuracy and range

M Mode measurement	System tolerance	Accuracy by	Test method
Axial distance	$\leq \pm (2\% \text{ of measurement} + 1\% \text{ full scale screen depth})$ ^a	Acquisition	Phantom ^b
Time	$\leq \pm (2\% + 1\% \text{ of full scale})$ ^c	Acquisition	Phantom ^d
Heart rate	$\leq \pm (2\% + 1\% \text{ of the inverse of the full scale})$ ^c	Acquisition	Phantom ^d

^aFull scale implies the maximum depth of the image.

^bA Gammex 403 model phantom was used.

^cFull scale implies the total time displayed on the scrolling graphic image.

^dFUJIFILM Sonosite special test equipment was used.

Table 37. PW Doppler mode measurement and calculation accuracy and range

Doppler mode measurement	System tolerance	Accuracy by	Test method ^a
Velocity cursor	$\leq \pm (2\% + 1\% \text{ of full scale})$ ^b	Acquisition	Phantom
Time	$\leq \pm (2\% + 1\% \text{ of full scale})$ ^c	Acquisition	Phantom

Doppler mode measurement	System tolerance	Accuracy by	Test method ^a
Heart rate	≤ +/- (2% + 1% of the inverse of the full scale ^c)	Acquisition	Phantom

^aFUJIFILM Sonosite special test equipment was used.

^bFull scale implies the velocity magnitude displayed on the scrolling graphic image.

^cFull scale implies the total time displayed on the scrolling graphic image.

In general, two types of errors can be introduced into the measurement:

- **Acquisition Error:** Includes errors introduced by the ultrasound system electronics relating to signal acquisition, signal conversion, and signal processing for display. Additionally, computational and display errors are introduced by the generation of the pixel scale factor, application of that factor to the caliper positions on the screen, and the measurement display.
- **Algorithmic Error:** The error introduced by measurements, which are input to higher order calculations. This error results from imprecision in the method used to carry out mathematical computations, usually associated with either rounding or truncation of numbers.

Measurement publications and terminology

The following are the publications and terminology used for each calculation result.

Terminology and measurements comply with American Institute of Ultrasound in Medicine (AIUM) published standards.

Cardiac references

Aortic Valve Area (AVA) in cm² by VMax

Baumgartner, H., Hung, J. et al. "Recommendations on the Echocardiographic Assessment of Aortic Valve Stenosis: A Focused Update from the European Association of Cardiovascular Imaging and the American Society of Echocardiography." *Journal of the American Society of Echocardiography* (2017), 30: p.372-392.

$$A2 = A1 * V1 / V2$$

where:

A2 = Ao valve area; A1 = LVOT area (CSA); V1 = LVOT velocity; V2 = Ao valve velocity; LVOT = Left Ventricular Outflow Tract

Aortic Valve Area (AVA) in cm² by VTI

Baumgartner, H., Hung, J. et al. "Echocardiographic assessment of valve stenosis: EAE/ASE recommendations for clinical practice." *Eur J Echocardiogr.* (2009), 10: p.1-25.

$$AVA = (CSA_{LVOT} \times VTI_{LVOT}) / VTI_{AV}$$

where:

CSA_{LVOT} = LVOT area (CSA); VTI_{LVOT} = LVOT velocity; VTI_{AV} = Ao valve velocity; LVOT = Left Ventricular Outflow Tract

Aortic Valve Area (AVA) index

Baumgartner, H., Hung, J. et al. "Echocardiographic assessment of valve stenosis: EAE/ASE recommendations for clinical practice." *Eur J Echocardiogr.* (2009), 10: p.1-25.

AVA/BSA

where:

AVA is AVA by V_{Max} or AVA by VTI; BSA = Body Surface Area in m²

Aortic Valve Velocity ratio

Baumgartner, H., Hung, J. et al. "Echocardiographic assessment of valve stenosis: EAE/ASE recommendations for clinical practice." *Eur J Echocardiogr.* (2009), 10: p.1-25.

AV velocity ratio = V_{LVOT} / V_{AV}

where:

V_{LVOT} = The maximum velocity recorded at the left ventricular outflow tract

V_{AV} = The maximum velocity recorded at the aortic valve

Body Surface Area (BSA) in m²

Grossman, W. *Cardiac Catheterization and Angiography*. Philadelphia: Lea and Febiger (1980), p.90.

BSA = $0.007184 * \text{Weight}^{0.425} * \text{Height}^{0.725}$; Weight = kilograms; Height = centimeters

Cardiac Index (CI) in L/min/m²

Oh, J.K., Seward, J.B., A.J. Tajik. *The Echo Manual*. 3rd ed., Lippincott, Williams, and Wilkins (2007), p.69-70.

CI = CO/BSA

where:

CO = Cardiac Output

Cardiac Output (CO) from dimensions in L/min

Hayashi, T., Kihara, Y. et al. "The Terminology and Diagnostic Criteria Committee of The Japan Society of Ultrasonics in Medicine Standard measurement of cardiac function indexes." *J Med Ultrasonic* (2006), 33: p.123-127 DOI 10.1007/s10396-006-0100-4 © The Japan Society of Ultrasonics in Medicine 2006, page 123.

CO = SV * HR

where:

CO = Cardiac Output; SV = Stroke Volume (mL); HR = Heart Rate

Cardiac Output (CO) from Doppler VTI in L/min

Porter, T.R., Shillcutt, S.K. et al. "Guidelines for the Use of Echocardiography as a Monitor for Therapeutic Intervention in Adults: A Report from the American Society of Echocardiography." *J Am Soc Echocardiogr.* (2015), 28: p.40-56.

CO = (SV* HR)/1000

where:

CO = Cardiac Output; Stroke Volume (SV) = CSA * VTI in mL

CSA = Cross Sectional Area of the site; HR = Heart Rate

Cardiac Output (CO) percent change

Evans, D., Ferraioli, G. et al. "Volume Responsiveness in Critically Ill Patients." *AIUM (2014), J Ultrasound Med (2014), 33: p.3-7.*

CO % change = [(post CO – pre CO)/post CO] * 100

Cross Sectional Area (CSA) in cm²

Allan, P.L., Pozniak, M.A. et al. *Clinical Doppler Ultrasound*. 4th ed., Harcourt Publishers Limited (2000), p.36-38.

CSA = $\pi/4 * D^2$

where: D = diameter of the anatomy of interest

Delta Pressure/Delta Time (dP/dt) in mmHg/s

Kolias, T.J., Aaronson, K.D., and W. F. Armstrong. "Doppler-Derived dP/dt and -dP/dt Predict Survival in Congestive Heart Failure." *J Am Coll Cardiol.* (2000), p.1594-1599.

$$\frac{dP}{dt} = \frac{32 \text{ mmHG}}{\text{time interval}}$$

Rate of change in pressure over the measured time interval in mmHg/second.

where:

$P = 4v^2$; $P = 32 \text{ mmHg}$; $32 \text{ mmHg} = 4V_2^2 - 4V_1^2$; $V_1 = 1 \text{ meters/second velocity}$; $V_2 = 3 \text{ meters/second velocity}$

Distensibility Index of Inferior Vena Cava (dIVC) in percent

Barbier, C., Loubières, Y. et al. "Respiratory changes in inferior vena cava diameter are helpful in predicting fluid responsiveness in ventilated septic patients." *Intensive Care Med.* (2004), 30: p.1740.

dIVC = [(Dmax – Dmin) / Dmin] * 100

where:

Dmax = IVC diameter at end-inspiration; Dmin = IVC diameter at end-expiration

E/A ratio

Caballero, L., Kou, S. et al. "Echocardiographic reference ranges for normal cardiac Doppler data: results from the NORRE Study." *Cardiovascular Imaging* (2015), 16: p.1031-1041.

mitral valve E wave velocity/PW A wave velocity

where:

E velocity = Peak velocity of early diastolic transmitral flow

A velocity = Peak velocity of late transmitral flow with the sample volume placed at the mitral leaflet tips

E/e' ratios

Caballero, L., Kou, S. et al. "Echocardiographic reference ranges for normal cardiac Doppler data: results from the NORRE Study." *Cardiovascular Imaging* (2015), 16: p.1031-1041.

mitral valve E wave velocity/TDI-PW e' velocity

where:

TDI-PW e' velocity can be measured for septal, lateral, inferior or anterior ventricular walls

Elapsed Time (ET) in msec

ET = time between velocity cursors in milliseconds

Heart Rate (HR) in bpm

HR = three digit value input by user or measured on M Mode and Doppler image in one heart cycle

Interventricular Septum Fractional Thickening (IVSFT) in percent

Laurenceau, J.L. and M.C. Malergue. *The Essentials of Echocardiography*. Le Hague: Martinus Nijhoff (1981), p.71.

$IVSFT = [(IVSs - IVSd)/IVSd] * 100$

where:

IVSs = Interventricular Septal Thickness at systole

IVSd = Interventricular Septal Thickness at diastole

Interventricular Septum (IVS)/Left Ventricular Posterior Wall (LVPW) ratio

Kansal, S., Roitman, D., and L.T. Sheffield. "Interventricular septal thickness and left ventricular hypertrophy. An echocardiographic study." *Circulation* (1979), 60: p.1058.

IVS/LVPW ratio = IVS/LVPW

where:

IVS = Interventricular Septum length

Isovolumic Relaxation Time (IVRT) in msec

Quiñones, M.A., Otto, C.M. et al. "Recommendations for quantification of Doppler echocardiography: a report from the Doppler Quantification Task Force of the Nomenclature and Standards Committee of the American Society of Echocardiography." *J Am Soc Echocardiogr*. February (2002), 15(2): p.167-184.

IVC Percentage Collapse

Lyon, M. and N. Verma. "Ultrasound guided volume assessment using inferior vena cava diameter." *The Open Emergency Medicine Journal* (2010), 3: p.22-24.

$$\text{IVC Collapse} = (\text{IVCd exp} - \text{IVCd insp}) / \text{IVCd exp} * 100$$

where:

IVCd exp = Inferior Vena Cava diameter with expiration (maximum diameter)

IVCd insp = Inferior Vena Cava diameter with inspiration (minimum diameter)

Left Atrial/Aorta (LA/Ao)

Feigenbaum, H. *Echocardiography*. Philadelphia: Lea and Febiger (1994), p.206, Figure 4-49.

where:

LA = Left Atrial dimension

Ao = Aortic root dimension

Left Atrial Volume: Biplane Method in mL

Lang, R., Bierig, M. et al. "Recommendations for Cardiac Chamber Quantification by Echocardiography in Adults: An Update from the American Society of Echocardiography and the European Association of Cardiovascular Imaging." *J Am Soc Echocardiogr*. January (2015), 28: p.1-39.

$$V = \left(\frac{\pi}{4}\right) \sum_{i=1}^n a_i b_i \left(\frac{L}{n}\right)$$

Simpson's method is used to model the chamber as a stack of elliptical disks.

where:

V = volume in mL

a_i = diameter of major axis of elliptical disk i in mm

b_i = diameter of minor axis of elliptical disk i in mm

n = number of disks (n = 20)

L = length of the chamber

i = disk index

Left Atrial Volume: Single Plane Method in mL

Lang, R., Bierig, M. et al. "Recommendations for Cardiac Chamber Quantification by Echocardiography in Adults: An Update from the American Society of Echocardiography and the

European Association of Cardiovascular Imaging." *J Am Soc Echocardiogr.* January (2015), 28: p.1-39.

$$V = \left(\frac{\pi}{4}\right) \sum_{i=1}^n a_i^2 \left(\frac{L}{n}\right)$$

Simpson's method is used to model the chamber as a stack of circular disks.

where:

V = volume in mL

a_i = diameter of disk i in mm

n = number of disks (n = 20)

L = length of chamber, measured from the midpoint of the line connecting the two opposite sides of the mitral ring and the most distant point (apex) of the chamber contour

i = disk index

Left Atrial Volume index

Lang, R., Bierig, M. et al. "Recommendations for Cardiac Chamber Quantification by Echocardiography in Adults: An Update from the American Society of Echocardiography and the European Association of Cardiovascular Imaging." *J Am Soc Echocardiogr.* January (2015), 28: p.1-39. LAVI = LA Vol/BSA

where:

LAVI = Left Atrial Volume Index

LA Vol = volume in mL

BSA = Body Surface Area in m^2

Left Ventricular Dimension Fractional Shortening (FS) in percent

Hayashi, T., Kihara, Y. et al. "The Terminology and Diagnostic Criteria Committee of The Japan Society of Ultrasonics in Medicine Standard measurement of cardiac function indexes." *J Med Ultrasonics* (2006), 33: p.123-127 DOI 10.1007/s10396-006-0100-4 © The Japan Society of Ultrasonics in Medicine 2006, page 123.

$$LVDFS = [(LVDd - LVDs)/LVDd] * 100$$

where:

LVDd = Left Ventricle Dimension at diastole

LVDs = Left Ventricle Dimension at systole

Left Ventricular (LV) Ejection Fraction in percent

Schiller, N.B., Shah, P.M. et al. "Recommendations for Quantification of the Left Ventricle by Two-Dimensional Echocardiography." *J Am Soc Echocardiogr.* September-October (1989), 2: p.364.

$$EF = [(End Diastolic Volume - End Systolic Volume) / End Diastolic Volume] * 100.$$

Hayashi, T., Kihara, Y. et al. "The Terminology and Diagnostic Criteria Committee of The Japan Society of Ultrasonics in Medicine Standard measurement of cardiac function indexes." *J Med Ultrasonics* (2006), 33: p.123-127 DOI 10.1007/s10396-006-0100-4 © The Japan Society of Ultrasonics in Medicine 2006, page 123.

$$EF = [(LVEDV - LVESV) / LVEDV] * 100$$

where:

$$LVEDV = \text{Left Ventricular End Diastolic Volume} = (7.0 * LVDD^3) / (2.4 + LVDD)$$

LVDD = LV Dimension at Diastole (cm)

$$LVESV = \text{Left Ventricular End Systolic Volume} = (7.0 * LVDD^3) / (2.4 + LVDD)$$

LVDS = LV Dimension at Systole (cm)

Left Ventricular End Volumes linear dimensions in mL

Hayashi, T., Kihara, Y. et al. "The Terminology and Diagnostic Criteria Committee of The Japan Society of Ultrasonics in Medicine Standard measurement of cardiac function indexes." *J Med Ultrasonics* (2006), 33: p.123-127 DOI 10.1007/s10396-006-0100-4 © The Japan Society of Ultrasonics in Medicine 2006, page 123.

$$LVESV = (7.0 * LVDs^3) / (2.4 + LVDs)$$

where:

LVESV = Left Ventricular End Systolic Volume (mL)

LVDs = Left Ventricular Dimension at systole (cm)

$$LVEDV = (7.0 * LVDd^3) / (2.4 + LVDd)$$

where:

LVEDV = Left Ventricular End Diastolic Volume (mL)

LVDd = Left Ventricular Dimension at diastole (cm)

Left Ventricular Fractional Area Change (FAC) in percent

Dennis, A.T., Castro, J. et al. "Haemodynamics in women with untreated pre-eclampsia." *Anaesthesia* (2012), 67: p.1105-1118. LV FAC (%) = (LV EDA - LV ESA) / LV EDA * 100

where:

LV FAC = Left Ventricular Fractional Area Change (%)

LV EDA = Left Ventricular End-Diastolic Area (cm²)

LV ESA = Left Ventricular End-Systolic Area (cm²)

Left Ventricular mass in gm for 2D

Lang, R., Badano, L., et al. "Recommendations for Cardiac Chamber Quantification by Echocardiography in Adults: An Update from the American Society of Echocardiography and the European Association of Cardiovascular Imaging." J Am Soc Echocardiogr. (2015), 28: p.1-39.

$$\text{LV mass} = 1.05 * \{[(5/6) * A_1 * (a + d + t)] - [(5/6) * A_2 * (a + d)]\}$$

where:

A_1 = short axis area, diastole (Epi)

A_2 = short axis area, diastole (Endo)

a = long or semi major axis

d = truncated semi major axis from the widest short axis epicardial and cavity areas

a + d = LV Len = length of epicardium (Apical)

t = myocardial thickness = $\sqrt{(Epi / \pi)} - \sqrt{(Endo / \pi)}$

Left Ventricular mass in gm for M Mode

Lang, R., Badano, L., et al. "Recommendations for Cardiac Chamber Quantification by Echocardiography in Adults: An Update from the American Society of Echocardiography and the European Association of Cardiovascular Imaging." J Am Soc Echocardiogr. (2015), 13: p.1-39.

$$\text{LV mass} = 1.04 [(LVDd + LVPWd + IVSd)^3 - LVDd^3] * 0.8 + 0.6$$

where:

LVDd = diastolic LV internal dimension

LVPWd = diastolic inferolateral wall thickness

IVSd = diastolic interventricular septal thickness

1.04 = specific gravity of the myocardium

Left Ventricular mass index

Hashem, M.S., Kalashyan, H. et al. "Left Ventricular Relative Wall Thickness Versus Left Ventricular Mass Index in Non-Cardioembolic Stroke Patients." Medicine (2015), 94: e872.

$$\text{LV mass index} = \text{LV Mass} / \text{BSA}$$

where:

LV mass = The left ventricular mass in grams

BSA = Body Surface Area in m^2

Left Ventricular Outflow Tract (LVOT) area in cm^2

Quinones, M.A, Otto, C.M. et al. "Recommendations for quantification of Doppler echocardiography: a report from the Doppler Quantification Task Force of the Nomenclature

and Standards Committee of the American Society of Echocardiography." *J Am Soc Echocardiogr.* February (1989), 15: p.170.

$$\text{LVOT area} = (\pi/4) * (\text{LVOT D})^2$$

where:

LVOT D = Left Ventricular Outflow Tract Diameter

Left Ventricular Outflow Tract (LVOT) peak velocity percent variation

Miller, A. and J. Mandeville. "Predicting and Measuring Fluid Responsiveness with Echocardiography", *Echo Res Pract.* (2016), 3(2):G1-G12 DOI: 10.1530/ERP-16-0008.

$$\text{LVOT peak velocity \% variation} = 100 \times \{(\text{LVOT peak velocity max} - \text{LVOT peak velocity min}) / [(\text{LVOT peak velocity max} + \text{LVOT peak velocity min}) \times 0.5]\}$$

Left Ventricular Outflow Tract (LVOT) Velocity Time Integral (VTI) percent variation

Miller, A. and J. Mandeville. "Predicting and Measuring Fluid Responsiveness with Echocardiography", *Echo Res Pract.* (2016), 3(2):G1-G12 DOI: 10.1530/ERP-16-0008.

$$\text{LVOT VTI \% variation} = 100 \times \{(\text{LVOT VTI Max} - \text{LVOT VTI Min}) / [(\text{LVOT VTI Max} + \text{LVOT VTI Min}) \times 0.5]\}$$

Left Ventricular Posterior Wall Fractional Thickening (LVPWFT) in percent

Laurenceau, J. L. and M.C. Malergue. *The Essentials of Echocardiography.* Le Hague: Martinus Nijhoff (1981), p.71.

$$\text{LVPWFT} = [(\text{LVPWS} - \text{LVPWD}) / \text{LVPWD}] * 100$$

where:

LVPWS = Left Ventricular Posterior Wall Thickness at Systole

LVPWD = Left Ventricular Posterior Wall Thickness at Diastole

Left Ventricular Volume: Biplane Method in mL

Schiller, N.B., Shah, P.M. et al. "Recommendations for Quantitation of the Left Ventricle by Two-Dimensional Echocardiography." *Journal of American Society of Echocardiography.* September-October (1989), 2: p.362.

$$V = \left(\frac{\pi}{4}\right) \sum_{i=1}^n a_i b_i \left(\frac{L}{n}\right)$$

Simpson's method is used to model the chamber as a stack of elliptical disks.

where:

V = volume in mL

a_i = diameter of major axis of elliptical disk *i* in mm

b_i = diameter of minor axis of elliptical disk i in mm

n = number of disks ($n = 20$)

L = length of the chamber

i = disk index

Left Ventricular Volume: Single Plane Method in mL

Schiller, N.B., Shah, P.M. et al. "Recommendations for Quantitation of the Left Ventricle by Two-Dimensional Echocardiography." *Journal of American Society of Echocardiography*. September-October (1989), 2: p.362.

$$V = \left(\frac{\pi}{4}\right) \sum_{i=1}^n a_i^2 \left(\frac{L}{n}\right)$$

Simpson's method is used to model the chamber as a stack of circular disks.

where:

V = volume

a_i = diameter of disk i in mm

n = number of disks ($n = 20$)

L = length of chamber, measured from the midpoint of the line connecting the two opposite sides of the mitral ring and the most distant point (apex) of the chamber contour

i = disk index

Mean Pressure Gradient (PG) in mmHG

Baumgartner, H., Hung, J., et al. "Echocardiographic Assessment of Valve Stenosis: EAE/ASE Recommendations for Clinical Practice". *Journal of American Society of Echocardiography*. January (2009), p. 4-5.

$$PG_{mean} = \frac{4}{N} \sum_{i=1}^N v_i^2$$

where:

v_i = instantaneous traced maximum Doppler velocity at time i (in m/s): N = the number of evenly distributed times at which the maximum velocity is taken between two delimiters

Mitral Annular Plane Systolic Excursion (MAPSE)

Matos, J., Kronzon, I., et al. "Mitral Annular Plane Systolic Excursion as a Surrogate for Left Ventricular Ejection Fraction." *Journal of the American Society of Echocardiograph* (2012), p.969-974.

M Mode distance measurement of systolic excursion of the left ventricle.

Mitral Valve Area (MVA) by PHT in cm²

Quinones M, Otto C, et al. Recommendations for Quantification of Doppler Echocardiography: A Report from the Doppler Quantification Task Force of the Nomenclature and Standards Committee of the American Society of Echocardiography. (2002), p.176-177.

$$MVA = 220/PHT$$

where:

PHT = pressure half time

Mitral Valve Area (MVA) by VTI in cm²

Nakatani, S., Masuyama, T., et al. "Value and limitations of Doppler echocardiography in the quantification of stenotic mitral valve area: comparison of the pressure half-time and the continuity equation methods." *Circulation* (1988), 77: p.78-85.

$$MVA = \text{Stroke volume}/VTI_{\text{mitral}}$$

where:

Stroke volume = Cross Sectional Area of the orifice (LVOT area) * Velocity Time Integral of the orifice (LVOT VTI)

VTI_{mitral} = VTI of flow out of the mitral valve

Pressure Gradient (PGMax) in mmHG

Oh, J.K., Seward, J.B., and A.J. Tajik. The Echo Manual. 3rd ed., Philadelphia: Lippincott, Williams, and Wilkins (2007), p.63-66.

$$PGMax = 4 * (\text{Velocity})^2 \text{ (velocity units must be meters/second)}$$

Pressure Half Time (PHT) in msec

Teague, S.M., Heinsimer, J.A. et al. "Quantification of aortic regurgitation utilizing continuous wave Doppler ultrasound." *Journal of the American College of Cardiology* (1986), p.592-599.

$$PHT = DT * 0.29 \text{ (time required for the pressure gradient to fall half its maximum level)}$$

where:

DT = Deceleration time

Qp/Qs ratio

Kitabatake, A., Inoue, M. et al. *Noninvasive evaluation of the ratio of pulmonary to systemic flow in atrial septal defect by duplex Doppler echocardiography*, (1984), p.73-79.

$$Qp/Qs = RSV/LSV$$

where:

Qp = Pulmonic flow

Qs = Systemic flow

RSV = Right Ventricular Stroke Volume

LSV = Left Ventricular Stroke Volume

Right Atrial Volume: Single Plane Method in mL

Lang, R., Bierig, M., et al. "Recommendations for chamber quantification: a report from the American Society of Echocardiography's guidelines and standards committee and the chamber quantification writing group, Developed in conjunction with the European Association of Echocardiography, a branch of the European Society of Cardiology." *J Am Soc Echocardiogr.* (2005), 18: p.1440-1463.

Lang, R., Badano, L.P. et al. "Recommendations for Cardiac Chamber quantification by Echocardiography in Adults: An update from the American Society of Echocardiography and European Association of Cardiovascular Imaging." *J Am Soc Echocardiogr.* January (2015), 28: p.1-39.

$$V = \left(\frac{\pi}{4}\right) \sum_{i=1}^n a_i^2 \left(\frac{L}{n}\right)$$

Simpson's method is used to model the chamber as a stack of circular disks.

where:

V = Volume

a_i = Diameter of disk *i* in mm

n = Number of disks (n = 20)

L = Length of chamber, measured from the midpoint of the line connecting the two opposite sides of the mitral ring and the most distant point (apex) of the chamber contour

i = Disk index

Right Atrial Volume Index in mL/m²

Darahim, K. "Usefulness of right atrial volume index in predicting outcome in chronic systolic heart failure." *Journal of the Saudi Heart Association.* April (2014), 26(2): p. 73-79.

RA Vol Index = RA Vol/BSA (mL/m²)

where:

RAVI = Right Atrial Volume Index

RA Vol = Right Atrial Volume in mL

BSA = Body Surface Area in m²

Right Ventricular Fractional Area Change (FAC) in percent

Lang, R., Badano, L.P. et al. "Recommendations for Cardiac Chamber quantification by Echocardiography in Adults: An update from the American Society of Echocardiography and European Association of Cardiovascular Imaging." *J Am Soc Echocardiogr.* January (2015), 28: p.1-39.

$$\text{RV FAC (\%)} = (\text{RV EDA} - \text{RV ESA}) / \text{RV EDA} * 100$$

where:

RV FAC = Right Ventricular Fractional Area Change (%)

RV EDA = Right Ventricular End-diastolic area (cm²)

RV ESA = Right Ventricular End-systolic area (cm²)

Right Ventricular Index of Myocardial Performance (RIMP)

Rudski, L.G., Lai, W.W. et al. "Guidelines for the Echocardiographic Assessment of the Right Heart in Adults: A Report from the American Society of Echocardiography." *J Am Soc Echocardiogr.* (2010), 23: p.685-713.

$$\text{RIMP} = (\text{IVRT} + \text{IVCT}) / \text{ET}$$

where:

IVCT = Isovolumic Contraction Time

IVRT = Isovolumic Relaxation Time

ET = Ejection Time

Right Ventricular Systolic Pressure (RVSP) in mmHg

Armstrong, D.W.J., Tsimiklis G., and Matangi, M.F. "Factors influencing the echocardiographic estimate of right ventricular systolic pressure in normal patients and clinically relevant ranges according to age." *Can J Cardiol.* (2010), 26(2): p.e35-e39.

$$\text{RVSP} = 4 * (\text{TR VMax})^2 + \text{RAP}$$

where:

RAP = Right Atrial Pressure

TR VMax = Tricuspid Regurgitation Maximum Velocity

S/D

Zwiebel, W. J. *Introduction to Vascular Ultrasonography*, 4th Edition. W.B. Saunders Company (2000), p.52.

$$|\text{S velocity} / \text{D velocity}|$$

where:

S velocity = Peak systolic velocity; D velocity = End diastolic velocity

Stroke Index (SI) in cc/m²

Mosby's Medical, Nursing, & Allied Health Dictionary, 4th ed. (1994), p.1492.

SI = SV/BSA

where:

SV = Stroke Volume; BSA = Body Surface Area

Stroke Volume (Doppler) in mL

Porter, T.R., Shillcutt, S.K. et al. "Guidelines for the Use of Echocardiography as a Monitor for Therapeutic Intervention in Adults: A Report from the American Society of Echocardiography." *J Am Soc Echocardiogr* (2015), 28:p.40-56.

SV = (CSA * VTI)

where:

CSA = Cross Sectional Area of the orifice (LVOT area)

VTI = Velocity Time Integral of the orifice

Stroke Volume (Doppler) percent change

Evans, D., Ferraioli, G. et al. "Volume Responsiveness in Critically Ill Patients." *AIUM* (2014), *J Ultrasound Med.* (2014), 33: p.3-7.

% change SV = [(post SV – pre SV)/post SV] * 100

Stroke Volume (Doppler) percent variation

Miller, A. and J. Mandeville. "Predicting and Measuring Fluid Responsiveness with Echocardiography." *Echo Res Pract.* (2016), 3(2):G1-G12 DOI: 10.1530/ERP-16-0008.

SV % variation = 100 x {(SV Max – SV Min) / [(SV Max + SV Min) x 0.5]}

Tricuspid Annular Plane Systolic Excursion (TAPSE)

Rudski, L., Lai W. et al. "Guidelines for the echocardiographic assessment of the right heart in adults: a report from the American Society of Echocardiography." *J Am Soc Echocardiogr.* (2010), p.685-713.

M Mode distance measurement of systolic excursion of the right ventricle

Velocity Time Integral (VTI) percent change

Evans, D., Ferraioli, G. et al. "Volume Responsiveness in Critically Ill Patients." *AIUM* (2014), *J Ultrasound Med.* (2014), 33: p.3-7.

% change LVOT VTI = [(post LVOT VTI – pre LVOT VTI)/post LVOT VTI] * 100

Obstetrical references

Amniotic Fluid Index (AFI)

Jeng, C. J., Jou, T.J. et al. "Amniotic Fluid Index Measurement with the Four Quadrant Technique During Pregnancy." *The Journal of Reproductive Medicine.* July (1990), 35:7, p.674-677.

Average Ultrasound Age (AUA)

The system provides an AUA derived from the component measurements.

Biophysical Profile (BPP)

Manning, F.A. "Dynamic Ultrasound-Based Fetal Assessment: The Fetal Biophysical Profile Score." *Clinical Obstetrics and Gynecology* (1995), Volume 32, Number 1: p.26-44.

Cephalic Index (CI)

Hadlock, F.P., Deter, R.L. et al. "Estimating Fetal Age: Effect of Head Shape on BPD." *American Journal of Roentgenology* (1981), 137: p.83-85.

Estimated Date of Delivery (EDD) by Average Ultrasound Age (AUA)

Results are displayed as month/day/year.

EDD = system date + (280 days - AUA in days)

Estimated Date of Delivery (EDD) by Last Menstrual Period (LMP)

The date entered into the patient information for LMP must precede the current date.

Results are displayed as month/day/year.

EDD = LMP date + 280 days

Estimated Fetal Weight (EFW)

Hadlock, F.P., Harrist, R.B. et al. "Estimation of Fetal Weight with the Use of Head, Body, and Femur Measurements, A Prospective Study." *American Journal of Obstetrics and Gynecology*. February 1 (1985),151:3, p.333-337.

Estimated Fetal Weight percentile (EFW%)

Hadlock, F.P., Harrist, R.B. and J. Martinex-Poyer."In-utero Analysis of Fetal Growth: A Sonographic Weight Standard" *Radiology* (1991), Vol 181: p. 129-133 (Table1).

Gestational Age (GA) by Last Menstrual Period (LMP)

The gestational age derived from the LMP date entered on the patient form.

Results are displayed in weeks and days, and is calculated as follows:

GA (LMP) = System date - LMP date

Gestational Age (GA) by Estimated Due Date (EDD)

The gestational age derived from the EDD date entered on the patient form.

Results are displayed in weeks and days, and is calculated as follows:

GA (EDD) = System date - (EDD - 280)

Gestational age references

Abdominal Circumference (AC)

Hadlock, F.P., Deter, R.L. et al. "Estimating Fetal Age: Computer-Assisted Analysis of Multiple Fetal Growth Parameters." *Radiology*. (1984),152: p.497-501.

Australasian Society for Ultrasound in Medicine (ASUM) Standards of Practice. "Guidelines, Policies and Statements, Normal Ultrasonic Fetal Measurements Standard." (1991, Revised 2018). Variability: +/- 2SD from Westerway, S.C. Fetal-Measurements, Personal Communication (Sep 2019).

Biparietal Diameter (BPD)

Hadlock, F.P., Deter, R.L. et al. "Estimating Fetal Age: Computer-Assisted Analysis of Multiple Fetal Growth Parameters." *Radiology*(1984),152: p.497-501.

Australasian Society for Ultrasound in Medicine (ASUM) Standards of Practice. "Guidelines, Policies and Statements, Normal Ultrasonic Fetal Measurements Standard." (1991, Revised 2018). Variability: +/- 2SD from Westerway, S.C. Fetal-Measurements, Personal Communication (Sep 2019)

Crown Rump Length (CRL)

Hadlock, F.P., Shah, Y.P. et al. "Fetal Crown-Rump Length: Re-evaluation of Relation to Menstrual Age (5-18 weeks) with High-Resolution, Real-Time Ultrasound." *Radiology*. February (1992), 182: p.501-505.

Westerway, S.C., Davison, A., and Cowell, S. "Ultrasonic Fetal Measurements: New Australian standards for the new millennium". *Aust N Z J Obstet Gynaecol*. (2000), 40:297-302, p. 299.

Papageorghiou, A.T., Kennedy, S.H. et al. "International standards for early fetal size and pregnancy dating based on ultrasound measurement of crown-rump length in first trimester of pregnancy." *Ultrasound Obstet Gynecol*. (2014), 44(6): p. 641-8.

Femur Length (FL)

Hadlock, F.P., Deter, R.L. et al. "Estimating Fetal Age: Computer-Assisted Analysis of Multiple Fetal Growth Parameters." *Radiology*(1984), 152: p.497-501.

Australasian Society for Ultrasound in Medicine (ASUM) Standards of Practice. "Guidelines, Policies and Statements, Normal Ultrasonic Fetal Measurements Standard." (1991, Revised 2018). Variability: +/- 2SD from Westerway, S.C. Fetal-Measurements, Personal Communication (Sep 2019).

Gestational Sac (GS)

Hansmann, M., Hackelöer, B.-J. et al. *Ultrasound Diagnosis in Obstetrics and Gynecology*. New York: Springer-Verlag (1986), p.36 (Figure 4.2).

Nyberg, D.A., Hill, L.M. et al. "Transvaginal Ultrasound." *Mosby Yearbook* (1992), p.76.

Gestational sac measurements provide a fetal age based on the mean of one, two, or three distance measurements; however, Nyberg's gestational age equation requires all three distance measurements for an accurate estimate.

Head Circumference (HC)

Hadlock, F.P., Deter, R.L. et al. "Estimating Fetal Age: Computer-Assisted Analysis of Multiple Fetal Growth Parameters." *Radiology*(1984), 152: p.497-501.

Australasian Society for Ultrasound in Medicine (ASUM) Standards of Practice. "Guidelines, Policies and Statements, Normal Ultrasonic Fetal Measurements Standard." Appendix 4. (1991, Revised 2018).

Occipito-Frontal Diameter (OFD)

Hansmann, M., Hackelöer, B.-J. and Staudach, A. *Ultrasound Diagnosis in Obstetrics and Gynecology*. New York: Springer-Verlag (1985), p. 431 (Table 1).

Australasian Society for Ultrasound in Medicine (ASUM) Standards of Practice. "Guidelines, Policies and Statements, Normal Ultrasonic Fetal Measurements Standard." Appendix 4. (1991, Revised 2018).

Ratio calculations

FL/AC Ratio

Hadlock, F.P., Deter, R. L. et al. "A Date Independent Predictor of Intrauterine Growth Retardation: Femur Length/Abdominal Circumference Ratio," *American Journal of Roentgenology*. November (1983), 141: p.979-984.

FL/BPD Ratio

Hohler, C.W. and T.A. Quetel. "Comparison of Ultrasound Femur Length and Biparietal Diameter in Late Pregnancy," *American Journal of Obstetrics and Gynecology*. Dec. 1 (1981),141:7, p.759-762.

FL/HC Ratio

Hadlock, F.P., Harrist, R. B. et al. "The Femur Length/Head Circumference Relation in Obstetric Sonography." *Journal of Ultrasound in Medicine*. October (1984),3: p.439-442.

HC/AC Ratio

Campbell, S. and A. Thoms. "Ultrasound Measurements of the Fetal Head to Abdomen Circumference Ratio in the Assessment of Growth Retardation." *British Journal of Obstetrics and Gynaecology*. March (1977), 84: p.165-174.

General references

+/x or S/D Ratio

$+/x = (\text{Velocity A}/\text{Velocity B})$

where:

A = velocity cursor +; B = velocity cursor x

Area in cm²

Beyer, W.H. *Standard Mathematical Tables*. 28th ed., CRC Press, Boca Raton, FL. (1987), p.131.

$A = \text{abs}\{0.5 * \sum [x_i y_{(i+1)} - x_{(i+1)} y_i]\}$

where the sum is over the list of points i, with rectilinear coordinates x_i and y_i , that define the traced contour around the area to be computed.

Carotid blood flow

Ma, I.W.Y., Caplin, J.D. et al. "Correlation of carotid blood flow and corrected carotid flow time with invasive cardiac output measurements." *Crit. Ultrasound J.* 2017;9:10. doi: 10.1186/s13089-017-0065-0. <https://www.ncbi.nlm.nih.gov/pmc/articles/PMC5398973/>

Catheter to vessel ratio

Sharp, R., Cummings, M. et al. "The catheter to vein ratio and rates of symptomatic venous thromboembolism in patients in patients with a peripherally inserted central catheter (PICC): A prospective cohort study." *Int. J. Nurs. Stud.* 2015; 52(3): p.677-685; doi: 10.1016/j.ijnurstu.2014.12.002.

(catheter diameter/vein diameter) * 100

Spencer, T. R., Mahoney, K. J. (2017). Reducing catheter-related thrombosis using a risk reduction tool centered on catheter to vessel ratio. *Journal of Thrombosis and Thrombolysis*, 44(4), 427-434. <https://doi.org/10.1007/s11239-017-1569-y>.

$(\pi(\text{catheter diameter}/2)^2 / \pi(\text{vessel diameter}/2)^2) * 100$

ISO 10555-5: 2013 Intravascular Catheters- Sterile and Single-use Catheters- Part 5: Over-needle Peripheral Catheters Table 1.

ISO 10555-1:2023 Intravascular Catheters- Sterile and Single-use Catheters- Part 1: General Requirements, Annex H, Section H.2

Fr = 3 x D (mm)

where:

D = outer size of diameter of a catheter in mm; Fr = French

Circumference (ellipse)

Bronshtein, I.N. and K.A. Semendyayev. *Handbook of Mathematics*. 3rd English ed., Van Nostrand Reinhold Co., New York (1985), p. 202.

$L = \pi(a + b) (64 - 3h^4)/(64 - 16h^2)$

where:

$h = (a - b)/(a + b)$; a = major radius; b = minor radius

Hip Angle/d:D Ratio

Graf, R. "Fundamentals of Sonographic Diagnosis of Infant Hip Dysplasia." *Journal of Pediatric Orthopedics* (1984), Vol. 4, No. 6: p.735-740.

Morin, C., Harcke, H., and G. MacEwen. "The Infant Hip: Real-Time US Assessment of Acetabular Development." *Radiology*. December (1985),177: p.673-677.

Peak velocity (VMax)

Walker, D. W., Acker, J. D., and C. A. Cole. "Subclavian steal syndrome detected with duplex pulsed Doppler sonography." *American Journal of Neuroradiology* (1982) 3.6: p. 615-618.

VMax = The maximum velocity magnitude within the period of time corresponding to the measurement tool, where VMax still maintains its +/- sign.

Pulsatility Index (PI)

Petersen, L.J., Pelsen, J.R. et al. "The pulsatility index and the resistive index in renal arteries. Associations with long-term progression in chronic renal failure." *Nephrol Dial Transplant* (1997), 12: p.1376-1380.

$$PI = (PSV - MDV)/V$$

where:

PSV = Peak systolic velocity

MDV = Minimum diastolic velocity

V = TAP (Time Averaged Peak) flow velocity throughout the cardiac cycle.

Renal Aortic Ratio (RAR)

Kohler, T.R., Zierler, R.E. et al. "Noninvasive diagnosis of renal artery stenosis by ultrasonic diagnosis of renal duplex scanning." *Journal of Vascular Surgery* (1986), Vol. 4, No 5: p. 450-456.

RAR = peak velocity of the renal artery/peak velocity of the aorta

Resistive Index (RI)

Kurtz, A.B. and W.D. Middleton. *Ultrasound-the Requisites*. Mosby Year Book, Inc. (1996), p.467.

RI = [(Peak Systolic Velocity - End Diastolic Velocity)/ Peak Systolic Velocity] in cm/s.

Slope in cm/s²

Zwiebel, W.J. *Introduction to Vascular Ultrasonography*. 4th ed., W.B. Saunders Company (2000), p.52.

Slope = abs (delta velocity/delta time)

Time (ET)

ET = time between velocity cursors in milliseconds

Time Averaged Mean (TAM) in cm/s

TAM = mean (mean Trace)

Time Averaged Peak (TAP) in cm/s

TAP = mean (peak Trace)

Velocity Time Integral (VTI) in cm

Oh, J.K., Seward, J.B., and A.J. Tajik. *The Echo Manual*. 3rd ed., Philadelphia: Lippincott, Williams, and Wilkins (2007), p.69-70.

VTI = Area enclosed by the baseline and Doppler spectrum = abs (Mean Velocity * duration of Doppler Trace)

Volume (Vol)

Beyer, W.H. *Standard Mathematical Tables*. 28th ed., CRC Press, Boca Raton, FL. (1987), p.131.

$$\text{Volume} = 4/3\pi * (D_1/2 * D_2/2 * D_3/2)$$

$$\text{Volume} = 4/3\pi * [D_1/2 * (D_2/2)^2]$$

$$\text{Volume} = 4/3\pi * (D_1/2)^3$$

where:

D = linear distance

Volume Bladder in mL

Dicuccio, M., Pomara G. et al. "Measurements of urinary bladder volume: comparison of five ultrasound calculation methods in volunteers." *Arch. Ital. Urol Androl* (2005) 77: p.60-62.

Bladder volume is measured using the ellipsoid volume method.

$$\text{Bladder volume} = 4/3\pi * (D_1/2 * D_2/2 * D_3/2)$$

Volume Flow in mL/m

Allan, P.L., Pozniak, M.A. et al. *Clinical Doppler Ultrasound*. 4th ed., Harcourt Publishers Limited. (2000), p.36-38

$$\text{Volume Flow} = \text{CSA (cm}^2) * \text{TAM (cm/s)} * 60$$

where:

TAM is the calculated Time Averaged Velocity from the mean trace

CSA = Cross Sectional Area of area of anatomy of interest = $(\pi/4) * (\text{Diameter})^2$, calculated based on 2D distance measurement for diameter.

Volume Ovarian

Balen, A.H., Laven, J.S., et al. "Ultrasound assessment of the polycystic ovary: international consensus definitions." *Human Reproduction Update* (2003), Vol. 9, No. 6, p. 505-514.

$$\text{Ovarian volume} = 4/3\pi * (\text{Height}/2 * \text{Length}/2 * \text{Width}/2)$$

Volume Uterine

Wiener, J. J. and R. G. Newcombe. "Measurements of uterine volume: a comparison between measurements by ultrasonography and by water displacement." *J. Clin. Ultrasound* (1992), 20 (7), p.457-460.

$$\text{Uterine volume} = 4/3\pi * (\text{Height}/2 * \text{Length}/2 * \text{Width}/2)$$

Troubleshooting and Maintenance

This section contains information to help correct problems with system operation, to enter a software license, and to take proper care of the system, transducer, and accessories.

Troubleshooting

If you encounter difficulty with the system, use the following list to help troubleshoot the problem. In the case of a warning dialogue, perform the suggested action. If the problem persists, contact FUJIFILM Sonosite Technical Support (see [Getting help \[2\]](#)).

System does not turn on

- Unplug and plug back in the power supply cables.
- Check the status of the power indicators (see [Power and battery indicators \[17\]](#)). You may be able to narrow the problem to a specific connection.

System image quality is poor

- Adjust the monitor to improve viewing angle.
- Adjust the monitor brightness (see [Adjusting brightness \[56\]](#)).
- Adjust the 2D gain (see [Adjusting the gain \[77\]](#)).
- Adjust 2D power (see [2D imaging controls \[69\]](#)).
- If adjusting the above settings does not improve image quality, assess your transducer's element status by viewing the transducer diagnostics report in the Logs settings page (see [Logs \[59\]](#)). If the report identifies elements that are performing poorly, close the log and then repeat the transducer diagnostics test by disconnecting all transducers and reconnecting the transducer of interest. You can then review the updated report in the Diagnostics log.

No color or CPD image. Adjust the gain, color power, or the color scale. Color and CPD have a **Hide Color** control. Ensure that this control is not activated.

No measurement selections. Ensure the desired exam type has been selected and that the image is frozen. Press the **Calcs**/ button.

No sound. If you do not hear system sounds when you use the system, make sure that you have configured audio settings correctly (see [Adjusting audio settings \[42\]](#)). If you still do not hear system sounds, cycle power: Turn the system off and back on. Some connections, such as connecting to the video out port, turn the system speakers off.



WARNING

Use only accessories and peripherals recommended by FUJIFILM Sonosite. Connection of accessories and peripherals not recommended by FUJIFILM Sonosite could result in electrical shock and system malfunction. Contact FUJIFILM Sonosite or your local representative for a list of accessories and peripherals available from or recommended by FUJIFILM Sonosite.

Printing does not work. Do any of the following:

- Check the printer connections. The system will automatically detect the printer. The system must also be connected to AC mains.
- Ensure that the local printer is turned on and set up properly. See the printer manufacturer's instructions, if necessary.

System does not recognize the transducer. Disconnect and reconnect the transducer.

The assert page  appears on screen. Follow the prompts on the page in the correct order: Note the information in the error message, including any error number that appears. Contact FUJIFILM Sonosite or your FUJIFILM Sonosite representative, then restart the system.

System prompts you to ensure the USB storage device is valid

- Use the USB storage device included with the system.
- Make sure that the USB storage device is not defective.

System prompts you to ensure the USB storage device contains valid data. Make sure that the data are present on the USB storage device. Re-export the original data onto the USB storage device. Contact your system administrator.

USB storage device does not appear in the list. Check that the USB storage device has been properly inserted into an available USB slot. Use the USB storage device that came with the system.

System displays the alert "...internal storage device is full. Free internal storage space by ending the current study, archiving or exporting patient studies, and then deleting them from the system.

Cannot access patient form. Cannot access patient list. Ensure that you are logged in as a user, not as a guest.

System does not transfer video clips (DICOM). In the **Archiver** settings, make sure that **Include video clips** is checked (see [Archiver configuration fields \[47\]](#)).

Software licensing

FUJIFILM Sonosite software is controlled by a license key. After you install new software, the system prompts you for a license key. You must obtain one key for each system and transducer package that uses the software. Software updates are available on a USB storage device or can be downloaded.

The software will operate for a short time (the grace period) without a license key. During the grace period, all system functions are available. After the grace period, the system is not usable until you enter a valid license key. Grace period time is not used while the system is off or asleep. Grace period time remaining appears on the license update screen.



CAUTION

After the grace period expires, all system functions except licensing are unavailable until you enter a valid license key.

Obtaining a license key

1. Turn on the system.
2. Navigate to system information to gather version information:
 - a. Tap the system menu  and then tap **System Settings**.
 - b. Tap **System Information** in the list on the left and scroll to display System Licensing.
3. Contact FUJIFILM Sonosite Technical Support (see [Getting help \[2\]](#)). You will be asked for the following information from system information:
 - a. Your name
 - b. System serial number
The serial number is on the rear of the system.
 - c. Software version
 - d. PCBA serial number
 - e. Previous license update
4. After you obtain a license key, you must enter it into the system.
You can enter it either at startup or in system settings.

Entering the license key at startup

1. Turn on the system.
The license update appears.
2. Enter the license key in the **Enter license key** box.
3. Tap **Enter**.
4. If the license update reappears, verify that you entered the license key correctly. If the license update still appears, contact FUJIFILM Sonosite Technical Support (see [Getting help \[2\]](#)).

Entering the license key in system settings

1. Tap the system menu , and then tap **System Settings**.
2. Tap **System Information** in the list on the left.
3. Enter the license key in the **Enter license key** area in the **System Licensing** section.
4. Tap **Enter**.



NOTE

Do not tap **Done**. This will close the form without entering the key.

Maintenance



WARNING

- No modification of this equipment, except as described in this manual, is allowed.
- Do not service or perform maintenance procedures on the system while it is in use with a patient.

No periodic or preventive maintenance, testing, or calibration is required for the system, transducer, or accessories other than cleaning and disinfecting transducers and inspecting them for cracks, adequate insulation, and other signs of damage after every use. Make sure that transducers and transducer cables do not have cracks or splitting that allow fluids or gel to enter. For information on cleaning and disinfecting your ultrasound system, see [Cleaning and Disinfecting \[156\]](#).

FUJIFILM Sonosite recommends that you periodically recharge the batteries by plugging the system in.



CAUTION

The batteries contain technology that requires periodic recharging to maintain optimal performance. If left uncharged for an extended period of time, the battery performance could degrade or become non-functional.

Performing maintenance procedures not described in this document or the service manual may void the product warranty. Contact FUJIFILM Sonosite Technical Support for any maintenance questions (see [Getting help \[2\]](#)).

System backups

To safeguard against loss of data, FUJIFILM Sonosite recommends that you routinely back up:

- Patient data
- System configuration settings
- DICOM configuration settings

Patient data

Digital Imaging and Communications in Medicine (DICOM) provides a way to archive patient data by connecting your ultrasound system with various archivers for storage after every patient study. FUJIFILM Sonosite recommends that you configure and use DICOM transfer to prevent patient data loss in the event of a system fault. For more information, see [About DICOM \[43\]](#).

If you do not use DICOM networking, then FUJIFILM Sonosite recommends that you export patient data to a USB storage device after every study. For more information, see [USB settings \[58\]](#).

System configuration settings

In addition to patient data, FUJIFILM Sonosite recommends that you back up ultrasound system configuration settings after you have fully configured the system and any time you modify these settings. These backups preserve your customized settings in case of a fault in the system.

Servicing

Your ultrasound system may be repaired or replaced at the manufacturer's discretion. If servicing is necessary, then you must remove the system from the stand (see [Removing or installing the Sonosite ST system \[13\]](#)).

Before the system is shipped to a repair facility, you must take precautions to protect patient data and to preserve your customized settings.



CAUTION

- To protect patient privacy, all patient procedure information must be exported to a USB storage device or archived to a secure repository via DICOM transfer and then deleted from the study list.
- You can remove the internal storage device for service purposes, but data on the device is encrypted for HIPAA compliance and will be lost.
- To preserve your configuration settings, export Presets and DICOM settings to a USB storage device and store the device in a secure location.

Preparing your system for service

1. End any in-progress procedures.
2. Export all patient procedure information to a USB storage device or archive it to a DICOM device. For complete instructions, see [Archiving studies \[122\]](#) and [Exporting studies \[124\]](#).
3. To delete all patient data, tap **Patient List** to access the study list.
4. Tap **Select All** and then tap **Delete**.
5. If using DICOM, navigate to the Patient Information form, then delete worklist data by tapping **Worklist** then **Clear**.
6. Export the following items to a USB storage device:
 - Configuration settings
 - System log file
 - Assert log file
 - User log file
 - DICOM log file (DICOM users only)
 - DICOM settings (DICOM users only)For information on importing and exporting, see [Importing and exporting connectivity settings \[50\]](#) and [Exporting a log \[60\]](#).
7. Prepare the system for shipping by isolating it from power (see [Isolating the ultrasound system from power \[173\]](#)).

Cleaning and Disinfecting

Use the FUJIFILM Sonosite recommendations in this section when cleaning or disinfecting your ultrasound system, stand, transducers, and accessories. Use the cleaning recommendations in the peripheral manufacturer's instructions when cleaning or disinfecting your peripherals.

The system and transducers must be cleaned and disinfected after each exam. It is important to follow these cleaning and disinfecting instructions without skipping any steps.

Before getting started

- Follow the disinfectant manufacturer's recommendations regarding appropriate personal protective equipment (PPE), such as protective eyewear and gloves.
- Inspect the system, transducer, and accessories to determine that they are free of any unacceptable deterioration, such as corrosion, discoloration, pitting, or cracked seals. If damage is evident, discontinue use, and contact FUJIFILM Sonosite or your local representative.
- Confirm that cleaning and disinfecting materials are appropriate for your facility's use. FUJIFILM Sonosite tests cleaners and disinfectants for use with FUJIFILM Sonosite systems and transducers.
- Disinfectants and cleaning methods listed in this section are recommended by FUJIFILM Sonosite for efficacy and material compatibility with the products.
- Ensure that the disinfectant type, concentration, and contact time are appropriate for the equipment and application.
- Follow manufacturer recommendations and local regulations, when preparing, using and disposing of chemicals.



NOTE

Do not let contaminating material dry on the transducer. Immediately after use, wipe the transducer using an approved cleaner then follow the detailed cleaning procedures presented in this chapter.



WARNING

- Ensure that cleaners and disinfectants are not expired.
- Some cleaners and disinfectants can cause an allergic reaction in some individuals.



CAUTION

- Do not allow cleaning solution or disinfectant into any electrical connectors.
- Do not use strong solvents such as thinner or benzene, or abrasive cleansers, since these will damage the exterior surfaces. Use only FUJIFILM Sonosite-approved cleaners or disinfectants.

Determining the required cleaning and disinfecting level



WARNING

- The cleaning instructions contained in this section are based on requirements mandated by the U.S. Food and Drug Administration (FDA). Failure to follow these instructions may result in cross contamination and patient infection.^a
- Even if you have used a transducer cover or sheath, you must follow the instructions to clean and disinfect the transducer.

The level of cleaning and disinfecting required for the system, stand, and transducer is determined by the type of tissue they have contacted or will contact during use. Use [Table 38, “Choosing a cleaning and disinfecting method” \[157\]](#) to determine the level of cleaning and disinfecting required.

Table 38. Choosing a cleaning and disinfecting method

Did, or will, any part of the system or transducer come in contact with broken skin or mucosal membranes?	
Yes	Option A Go to Option A: Clean and disinfect system, stand, and transducer to a high-level (semi-critical uses) [158]
No	Option B Go to Option B: Clean and disinfect the system, stand, and transducer to a low-level (non-critical uses) [162]

Spaulding classifications

Spaulding classifications determine the approach for cleaning and disinfecting medical equipment based on the device, the way it has been used, and the risk of infection.^b

- **Critical devices:** Critical devices are devices that are introduced directly into the bloodstream, or which contact a normally sterile tissue or body-space during use.
- **Semi-critical devices:** Semi-critical devices are devices that contact intact mucous membranes or non-intact skin.

^a*Reprocessing Medical Devices in Health Care Settings: Validation Methods and Labeling Guidance for Industry and Food and Drug Administration Staff.* Issued March 17, 2015, updated June 9, 2017.

^bSpaulding, E.H. “The Role of chemical disinfection in the prevention of nosocomial infections”. In: Brachman, P.S. and Eickof, T.C. (ed). *Proceedings of International Conference on Nosocomial Infections, (1970).* Chicago, IL: American Hospital Association. (1971), p. 254-274..

- **Non-critical devices:** Non-critical devices are instruments and other devices whose surfaces contact only intact skin and do not penetrate it, or do not contact the patient at all but may become contaminated during patient care.

The system and transducers are designed for use within the Spaulding classifications of non-critical and semi-critical uses.

Cleaning and disinfection definitions

- **Cleaning:** Physical removal of soil and contaminants from an item to the extent necessary for further processing or for the intended use.
- **Low-level disinfection:** A lethal process using an agent that kills vegetative forms of bacteria, some fungi, and lipid viruses
- **Intermediate disinfection:** A lethal process using an agent that kills viruses, mycobacteria, fungi and vegetative bacteria, but no bacterial spores
- **High-level disinfection:** A lethal process utilizing a sterilant under less than sterilizing conditions. The process kills all forms of microbial life except for large numbers of bacterial spores



NOTE

FUJIFILM Sonosite defines ultrasound guided percutaneous procedures as non-critical use applications. Following percutaneous procedures, users should follow cleaning and disinfecting transducers for non-critical uses as outlined in the user guide for their device.^c

Option A: Clean and disinfect system, stand, and transducer to a high-level (semi-critical uses)

Use this procedure to clean and high-level disinfect the ultrasound system and transducer **whenever they have, or will, come into contact with broken skin or mucosal membranes.**

Follow the manufacturer's instructions when using cleaners and disinfectants. The cleaners and disinfectants listed in the procedure are both chemically compatible and have been tested for efficacy with the system, stand, and transducers. Confirm that the cleaners and disinfectants are appropriate for your facility's use.



WARNING

- To avoid electrical shock before cleaning, turn off the system and disconnect it from the power supply.
- Wear the appropriate personal protective equipment (PPE) recommended by the chemical manufacturer, such as **protective eyewear** and **gloves**.

^c"Disinfection of Ultrasound Transducers Used for Percutaneous Procedures. Intersocietal Position Statement." *American Institute of Ultrasound in Medicine / J Ultrasound Med.* February 16, 2021; 9999: p. 1-3.



CAUTION

- Do not skip any steps or abbreviate the cleaning and disinfecting process in any way.
- Do not spray cleaners or disinfectants directly on the system surfaces or on system and transducer connectors. Doing so may cause solution to leak into the system, damaging it and voiding the warranty.
- Do not attempt to disinfect a transducer or transducer cable using a method that is not included here. Do not use a chemical not listed in this guide or on www.sonosite.com/support/cleaners-disinfectants. This can damage the transducer and void the warranty.
- Use only FUJIFILM Sonosite-approved cleaners and disinfectants. Using a non-approved disinfecting solution or incorrect solution strength can damage the system and transducer and void the warranty. Follow the disinfectant manufacturer's recommendations for solutions strengths.



NOTE

After every use, you must clean and disinfect, the ultrasound system, stand, and the transducer (up to an intermediate level). However, only the transducer can be disinfected to a high level.



WARNING

High-level disinfectants can cause harm to the patient if not completely removed from the transducer. Follow the manufacturer's rinse instructions to remove chemical residue.

1. Do one of the following:
 - a. Tap **Enter Cleaning Mode** on the touchscreen or from the system menu to freeze the controls. To exit cleaning mode, slide the control on the touchscreen.
 - b. Turn off the system by pressing the Power button and unplug the power cord from the outlet.
2. Remove the disposable transducer sheath, if applicable.
3. Disconnect transducers from the system. Temporarily place them where they will not cross-contaminate clean equipment or surfaces while you clean the ultrasound system.
4. Clean the exterior surfaces of the **ULTRASOUND SYSTEM** to remove any debris. Use the following procedure:
 - a. Use either a pre-moistened wipe or a soft cloth dampened with cleaner or a low- or intermediate-level disinfectant. Choose a cleaner from the list of approved cleaners.

Table 39. Approved cleaners/intermediate-level disinfectants for the system, stand, and all transducers

Product ^{a,b}
SaniCloth Prime
SaniCloth Bleach
Oxivir TB

^aFor a complete list of approved cleaners and disinfectants, refer to the cleaners and disinfectants tool available at www.sonosite.com/support/cleaners-disinfectants.

^bRefer to the manufacturer's instructions for concentration, temperature, and duration.

- b. Remove all gel and debris from the system.
- c. With a new wipe, clean the system, including any screens, by wiping from clean areas to the soiled areas. This method helps to avoid cross-contamination.



CAUTION

Do not use over-saturated wipes to clean the system. Over-saturated wipes may cause liquid to leak into the system.

- d. Refer to manufacturer's instructions for the wet contact time. Monitor for wet appearance. Reapply with a new wipe if no longer wet.
- e. Allow the ultrasound system to air dry in a clean, well-ventilated space.



NOTE

If the cleaner leaves a residue on the system's surfaces, wipe with distilled water or a clean, dry cloth.

5. Clean the ultrasound system **STAND AND PLATFORM** using the following procedure:
 - a. Use either a pre-moistened wipe or a soft cloth dampened with cleaner or a low- or intermediate-level disinfectant. Choose a cleaner from the list of approved cleaners in [Table 39, "Approved cleaners/intermediate-level disinfectants for the system, stand, and all transducers" \[160\]](#).
 - b. Remove all gel and debris from the stand and platform.
 - c. With a new wipe, clean the stand and platform by wiping from clean areas to the soiled areas. This method helps to avoid cross-contamination.
 - d. Refer to manufacturer's instructions for the wet contact time. Monitor for wet appearance. Reapply with a new wipe if no longer wet.
 - e. Allow the stand and platform to air dry in a clean, well-ventilated space.
6. Clean the **TRANSDUCER CABLE AND BODY** to remove any debris. Use the following procedure:
 - a. Use either a pre-moistened wipe or a soft cloth dampened with cleaner or a low- or intermediate-level disinfectant. Choose a cleaner from the list of approved cleaners in [Table 39, "Approved cleaners/intermediate-level disinfectants for the system, stand, and all transducers" \[160\]](#).
 - b. Remove all gel and debris from the transducer.
 - c. With a new wipe, clean the cable and transducer, starting from the cable, wiping toward the scanhead. This method helps to avoid cross-contamination.

Figure 11. Wiping the cable and transducer

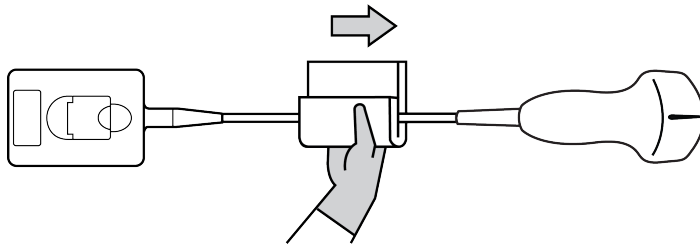

CAUTION

Do not allow moisture near the electronic components of the connector.

- d. Refer to manufacturer's instructions for the wet contact time. Monitor for wet appearance. Reapply with a new wipe if no longer wet.
- 7. Verify that all gel and debris have been removed from the system, stand, and transducer. If necessary, repeat all cleaning steps with a new wipe.



WARNING

Failure to remove all gel and debris could leave contaminants on the transducer.

- 8. Prepare the high-level disinfectant for use.
 - a. Choose a high-level disinfectant from the list of approved disinfectants.

Table 40. High-level disinfectants compatible with Sonosite ST transducers:

Product ^{a,b}	Compatible transducers
Cidex	C5-1, C10-3, L12-3, L13-6, L15-4, L19-5, IC10-3, P5-1
Cidex OPA	C5-1, C10-3, L12-3, L13-6, L15-4, L19-5, IC10-3, P5-1
Revital-Ox RESERT	C5-1, C10-3, L12-3, L13-6, L15-4, L19-5, IC10-3, P5-1

^aFor a complete list of approved cleaners and disinfectants, refer to the cleaners and disinfectants tool available at www.sonosite.com/support/cleaners-disinfectants.

^bRefer to the manufacturer's instructions for concentration, temperature, and duration.

- b. Check the expiration date on the bottle to ensure that the disinfectant has not expired.
- c. Check that the disinfection chemical has the concentration recommended by the manufacturer (for example, use a chemical strip test).
- d. Check that the temperature of the disinfectant is within the manufacturer's recommended limits.
- 9. Perform a high-level disinfection of the transducer by immersing the transducer in a high-level disinfectant and ensuring that the connector and at least 12 inches (31 cm) of the connecting cable remain out of the fluid.

Figure 12. Soaking the transducer in high-level disinfection

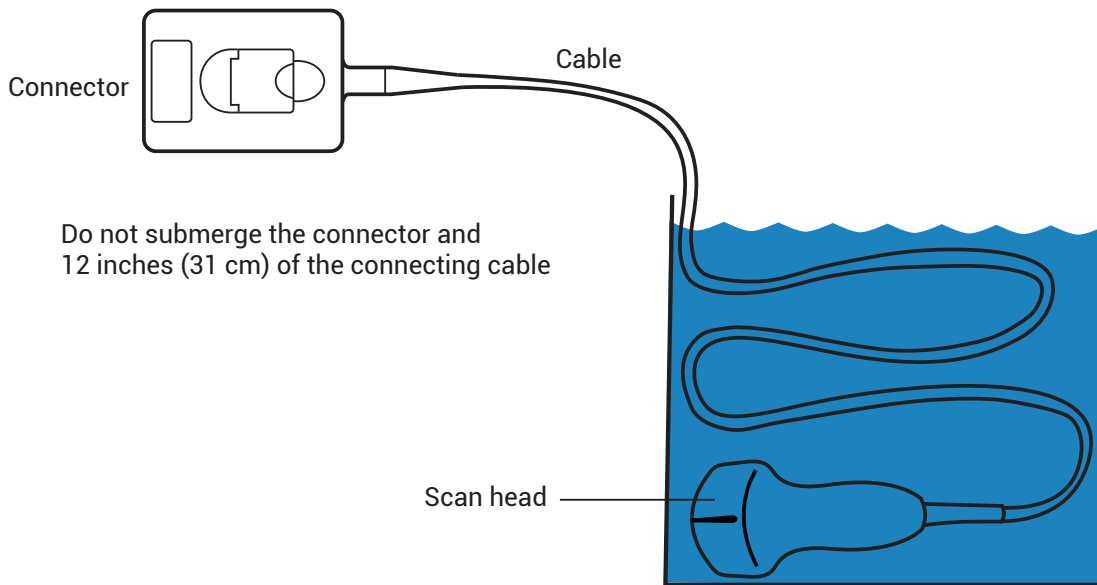

CAUTION

- Do not soak the transducer longer than recommended by the chemical manufacturer.
- Do not immerse the transducer connector in any disinfecting solution.
- Use only FUJIFILM Sonosite-approved cleaners and disinfectants. Using a non-recommended disinfecting solution or incorrect solution strength can damage or discolor the transducer and void the warranty.

10. Rinse the transducer three separate times in clean, running water or in a basin filled with clean water according to the disinfectant manufacturer's instructions, ensuring that the connector and at least 12 inches (31 cm) of the connecting cable remain out of the fluid.
11. Dry the transducer with a sterile, lint-free cloth.
12. Dispose of the disinfectant according to the manufacturer's guidelines.
13. Examine the transducer and cable for damage, such as cracks or splitting where fluid can enter. If damage is evident, discontinue use of the transducer, and contact FUJIFILM Sonosite or your local representative.

Option B: Clean and disinfect the system, stand, and transducer to a low-level (non-critical uses)

Use the following procedure to clean and disinfect the ultrasound system, stand, and transducer **if they have not, or will not, come into contact with broken skin or mucosal membranes.**

Follow the manufacturer's instructions when using cleaners and disinfectants. The cleaners and disinfectants listed in the procedure are both chemically compatible and have been tested for efficacy with the system, stand, and transducers. Confirm that the cleaners and disinfectants are appropriate for your facility's use.



WARNING

If the system or transducer has come into contact with any of the following, use the high-level cleaning and disinfection procedure.

- Broken skin
- Mucosal membranes



WARNING

- To avoid electrical shock before cleaning, turn off the system and disconnect it from the power supply.
- Wear the appropriate personal protective equipment (PPE) recommended by the chemical manufacturer, such as **protective eyewear** and **gloves**.



CAUTION

- Do not skip any steps or abbreviate the cleaning and disinfecting process in any way.
- Do not spray cleaners or disinfectants directly on the system surfaces or on system and transducer connectors. Doing so may cause solution to leak into the system, damaging it and voiding the warranty.
- Do not attempt to disinfect a transducer or transducer cable using a method that is not included here. Do not use a chemical not listed in this guide or on www.sonosite.com/support/cleaners-disinfectants. This can damage the transducer and void the warranty.
- Use only FUJIFILM Sonosite-approved cleaners and disinfectants. Using a non-approved disinfecting solution or incorrect solution strength can damage the system and transducer and void the warranty. Follow the disinfectant manufacturer's recommendations for solutions strengths.



NOTE

After every use, you must clean and disinfect, the ultrasound system, stand, and the transducer (up to an intermediate level). However, only the transducer can be disinfected to a high level.

1. Do one of the following:
 - a. Tap **Enter Cleaning Mode** on the touchscreen or from the system menu to freeze the controls. To exit cleaning mode, slide the control on the touchscreen.
 - b. Turn off the system by pressing the Power button and unplug the power cord from the outlet.

2. Remove the disposable transducer sheath, if applicable.
3. Disconnect the transducer from the system. Temporarily place it where it will not cross-contaminate clean equipment or surfaces while you clean the ultrasound system.
4. Clean the exterior surfaces of the **ULTRASOUND SYSTEM** to remove any debris. Use the following procedure:
 - a. Use either a pre-moistened wipe or a soft cloth dampened with cleaner or a low- or intermediate-level disinfectant. Choose a cleaner from the list of approved cleaners.

Table 41. Approved cleaners/intermediate-level disinfectants for the system, stand, and all transducers

Product ^{a,b}
SaniCloth Prime
SaniCloth Bleach
Oxivir TB

^aFor a complete list of approved cleaners and disinfectants, refer to the cleaners and disinfectants tool available at www.sonosite.com/support/cleaners-disinfectants.

^bRefer to the manufacturer's instructions for concentration, temperature, and duration.

- b. Remove all gel and debris from the system.
- c. With a new wipe, clean the system, including any screens, by wiping from clean areas to the soiled areas. This method helps to avoid cross-contamination.



CAUTION

Do not use over-saturated wipes to clean the system. Over-saturated wipes may cause liquid to leak into the system.

- d. Refer to manufacturer's instructions for the wet contact time. Monitor for wet appearance. Reapply with a new wipe if no longer wet.
- e. Allow the ultrasound system to air dry in a clean, well-ventilated space.



NOTE

If the cleaner leaves a residue on the system's surfaces, wipe with distilled water or a clean, dry cloth.

5. Clean the ultrasound system **STAND AND PLATFORM** using the following procedure:
 - a. Use either a pre-moistened wipe or a soft cloth dampened with cleaner or a low- or intermediate-level disinfectant. Choose a cleaner from the list of approved cleaners in [Table 41, "Approved cleaners/intermediate-level disinfectants for the system, stand, and all transducers" \[164\]](#).
 - b. Remove all gel and debris from the stand and platform.
 - c. With a new wipe, clean the stand and platform by wiping from clean areas to the soiled areas. This method helps to avoid cross-contamination.
 - d. Refer to manufacturer's instructions for the wet contact time. Monitor for wet appearance. Reapply with a new wipe if no longer wet.
 - e. Allow the stand and platform to air dry in a clean, well-ventilated space.
6. Clean the **TRANSDUCER CABLE AND BODY** to remove any debris. Use the following procedure:
 - a. Use either a pre-moistened wipe or a soft cloth dampened with cleaner or a low- or intermediate-level disinfectant. Choose a cleaner from the list of approved cleaners in

Table 41, "Approved cleaners/intermediate-level disinfectants for the system, stand, and all transducers " [164].

- b. Remove all gel and debris from the transducer.
- c. With a new wipe, clean the cable and transducer, starting from the cable, wiping toward the scanhead. This method helps to avoid cross-contamination.

Figure 13. Wiping the cable and transducer

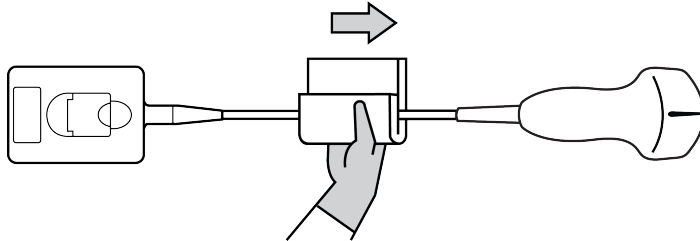

CAUTION

Do not allow moisture near the electronic components of the connector.

- d. Refer to manufacturer's instructions for the wet contact time. Monitor for wet appearance. Reapply with a new wipe if no longer wet.
7. Verify that all gel and debris have been removed from the system, stand, and transducer. If necessary, repeat all cleaning steps with a new wipe.



WARNING

Failure to remove all gel and debris could leave contaminants on the transducer.

8. Remove residual cleaner from the transducer by wiping with a sterile cloth or sponge moistened with sterile water.
To thoroughly remove any residue, you may want to rinse the transducer three separate times in clean, running water or in a basin filled with clean water. Make sure that the connector and at least 12 inches (31 cm) of the connecting cable remain out of the fluid.
9. Allow the ultrasound system, stand, and transducer to air dry in a clean, well-ventilated space.



NOTE

If the cleaner leaves a residue on the system's surfaces, wipe with distilled water or a clean, dry cloth.

10. Examine the system, transducer, and cable for damage, such as cracks or splitting where fluid can enter.
If damage is evident, do not use the transducer. Instead, contact FUJIFILM Sonosite or your local representative.

Storing the transducer

1. Make sure the transducer has been cleaned and disinfected as detailed in the previous section.
2. Store the transducer so that it hangs freely and vertically, and observe the following precautions:

- Store the transducer away from any contaminated transducers.
- Store the transducer in an environment that is safe and has good airflow. Do not store the transducer in closed containers or where condensation may occur.
- Avoid direct sunlight and exposure to X-rays. Recommended storage temperature range is between 0° C (32° F) and +45° C (113° F).
- If using a wall-mounted rack for storage, ensure that:
 - It is securely mounted.
 - The storage slots do not mar the transducer or cause damage to the cable.
 - The rack is sized and positioned to prevent the transducer from inadvertently falling.
 - Make sure the connector is supported and secure.

Transporting the transducer

When transporting the transducer, you must take precautions to protect the transducer from damage and avoid cross-contamination. Be sure to use a container approved by your organization.

Transporting a clean transducer

A clean transducer is one that has completed the cleaning and disinfection process, has been stored properly, and is ready to be used in an examination.

1. Place the transducer in a clean, approved container. To identify the transducer as clean, containers used to transport clean transducers should carry a cleanliness verification sticker or certificate.
2. Transport the transducer in the container to the point of use. Do not open the container until the transducer is ready to be used.

Shipping a transducer



WARNING

Whenever possible, avoid shipping a contaminated transducer. Before shipping, ensure the transducer has been cleaned and disinfected using the steps detailed in this section or according to special instructions received from FUJIFILM Sonosite. If you are returning the transducer to FUJIFILM Sonosite, document the disinfection on a "Declaration of Cleanliness," and attach it to the packing list.

1. Place the transducer in the shipping container and seal it. Do not allow any part of the transducer to protrude from the container.
2. Ship the transducer using the following precautions:
 - Clearly label the container as fragile.
 - Do not stack items on top of the shipping container.
 - Do not exceed the shipping temperature range: -35° C (-31° F) to +65° C (149° F).
 - Do not open the shipping container until it reaches its final destination.
 - After arrival, the transducer must be cleaned and disinfected before it can be used in an exam.

Cleaning and disinfecting accessories

Clean accessories prior to disinfecting. You can disinfect the exterior surface of accessories using an approved disinfectant. Refer to the cleaners and disinfectants tool available at www.sonosite.com/support/cleaners-disinfectants.

The following procedure applies to most Sonosite ST accessories. For detailed instructions, see the accessory user guide or use the cleaning and disinfecting recommendations in the peripheral manufacturer's instructions.



WARNING

To avoid electrical shock, always disconnect the power supply before cleaning the PowerPark.



CAUTION

To avoid damaging the stand battery, do not allow cleaning solution or disinfectant to come in contact with the battery terminals.

1. If necessary, unplug the power supply, and detach any cables.
2. Clean the exterior surfaces of the accessory using a pre-moistened wipe or soft cloth lightly dampened with an approved cleaner or mid-level disinfectant. Apply the solution to the cloth rather than the surface.
3. With a new wipe or moistened cloth, wipe the surfaces by wiping from clean areas to soiled areas.
4. Air dry or towel dry with a clean cloth.

Safety

This section contains general safety information that applies to the ultrasound system, transducers, accessories, and peripherals. Report any serious safety incident that occurs in relation to the ultrasound system to FUJIFILM Sonosite and to the competent authority of the country in which the user and patient are established.

Ergonomic safety

These scanning guidelines are intended to assist you in the comfortable and effective use of your ultrasound system.



WARNING

- To prevent musculoskeletal disorders, follow the guidelines in this section.
- Use of an ultrasound system may be linked to musculoskeletal disorders (MSDs).^{d,e,f}
- Use of an ultrasound system is defined as the physical interaction between the operator, the ultrasound system, and the transducer.
- When using an ultrasound system, as with many similar physical activities, you may experience occasional discomfort in your hands, fingers, arms, shoulders, eyes, back, or other parts of your body. However, if you experience symptoms such as constant or recurring discomfort, pain, throbbing, aching, tingling, numbness, burning sensation, or stiffness, do not ignore these warning signs. Promptly see a qualified health professional. Symptoms such as these can be linked with MSDs. MSDs can be painful and may result in potentially disabling injuries to the nerves, muscles, tendons, or other parts of the body. Examples of MSDs include carpal tunnel syndrome and tendonitis.



WARNING

While researchers are not able to definitively answer many questions about MSDs, there is a general agreement that certain factors are associated with their occurrence including preexisting medical and physical conditions, overall health, equipment and body position while doing work, frequency of work, duration of work, and other physical activities that may facilitate the onset of MSDs^g. This section provides guidelines that may help you work more comfortably and may reduce your risk of MSDs.^{h,i}

^dMagnavita, N., L. Bevilacqua, P. Mirk, A. Fileni, and N. Castellino. "Work-related Musculoskeletal Complaints in Sonologists." *Occupational Environmental Medicine*. 41:11 (1999), p. 981-988.

^eCraig, M. "Sonography: An Occupational Hazard?" *Journal of Diagnostic Medical Sonography*. 3 (1985), p.121-125.

^fSmith, C.S., G.W. Wolf, G. Y. Xie, and M. D. Smith. "Musculoskeletal Pain in Cardiac Ultrasonographers: Results of a Random Survey." *Journal of American Society of Echocardiography*. (May1997), p. 357-362.

^gWihlidal, L.M. and S. Kumar. "An Injury Profile of Practicing Diagnostic Medical Sonographers in Alberta." *International Journal of Industrial Ergonomics*. 19 (1997), p.205-216.

Position the system

Minimize eye and neck strain

- If possible, position the system within reach.
- Adjust the angle of the clinical monitor to minimize glare.
- Adjust the height so that the clinical monitor is at or slightly below eye level.

Position yourself

Support your back during an exam

- Use a chair that supports your lower back, that adjusts to your work surface height, that promotes a natural body posture, and that allows quick height adjustments.
- Always sit or stand upright. Avoid bending or stooping.

Minimize reaching and twisting

- Use a bed that is height adjustable.
- Position the patient as close to you as possible.
- Face forward. Avoid twisting your head or body.
- Move your entire body front to back, and position your scanning arm next to or slightly in front of you.
- Stand for difficult exams to minimize reaching.
- Position the monitor directly in front of you.

Promote comfortable shoulder and arm postures

- Keep your elbow close to your side.
- Relax your shoulders in a level position.
- Support your arm using a support cushion or pillow, or rest it on the bed.

Promote comfortable hand, wrist, and finger postures

- Hold the transducer lightly in your fingers.
- Minimize the pressure applied on the patient.
- Keep your wrist in a straight position.

Take breaks, exercise, and vary activities

- Minimizing scanning time and taking breaks can effectively allow your body to recover from physical activity and help you avoid MSDs. Some ultrasound tasks may require longer or more frequent breaks. However, simply changing tasks can help some muscle groups relax while others remain or become active.
- Work efficiently by using the software and hardware features correctly.
- Keep moving. Avoid sustaining the same posture by varying your head, neck, body, arm, and leg positions.

^hHabes, D.J. and S. Baron. "Health Hazard Report 99-0093-2749." University of Medicine and Dentistry of New Jersey. (1999).

ⁱVanderpool, H.E., E.A. Friis, B.S. Smith, and K.L. Harms. "Prevalence of Carpal Tunnel Syndrome and Other Work-related Musculoskeletal Problems in Cardiac Sonographers." *Journal of Medicine*. 35:6 (1993), p. 605-610.

- Do targeted exercises. Targeted exercises can strengthen muscle groups, which may help you avoid MSDs. Contact a qualified health professional to determine stretches and exercises that are right for you.

Electrical safety

This system meets EN60601-1, Class I/internally-powered equipment requirements and Type BF (transducers) isolated patient-applied parts safety requirements.

The system complies with the safety and EMC standards listed in the standards section of this document.

For maximum safety observe the following warnings and cautions.



WARNING

- To avoid discomfort or minor risk of patient injury, keep hot surfaces away from the patient.
- To avoid the risk of injury, do not operate the system in the presence of flammable gases or anesthetics. Explosion can result.
- To avoid the risk of electrical shock or injury, do not open system or accessory enclosures. All internal adjustments and replacements, except battery replacement, must be made by a qualified technician.



WARNING

To avoid the risk of electrical shock:

- Use only properly grounded equipment. Shock hazards exist if the power supply is not properly grounded. Grounding reliability can only be achieved when equipment is connected to a receptacle marked “Hospital Only,” “Hospital Grade,” or the equivalent. Do not remove or defeat the grounding wire.
- Connect this equipment to a supply mains with protective earth.
- Do not allow associated connectors for applied parts to contact any other conductive parts including earth.
- When using the system in an environment where the integrity of the protective earth conductor arrangement is in doubt, operate the system on battery power only without using the power supply.
- Do not let any part of the system (including the barcode scanner, power supply, or power supply connector), except for the transducer, touch the patient.
- While you are touching a patient, do not touch any of the following:
 - The system, stand, or connected accessories except for transducers.
 - The signal input/output connectors on the system and the stand.
 - The system battery contacts (inside the battery compartment).
 - The transducer connector on the system when a transducer is not connected.
- Do not connect the system’s AC power cord to mains power using an MPSO (power strip) or extension cord.
- Before using the transducer, inspect the transducer face, housing, and cable. Do not use the transducer if the transducer or cable is damaged.
- Turn the system off and disconnect the power supply from the system before cleaning the system.
- Do not use any transducer that has been immersed beyond the specified cleaning or disinfection level.
- Use only accessories and peripherals recommended by FUJIFILM Sonosite, including the power supply. Connection of accessories and peripherals not recommended by FUJIFILM Sonosite could result in electrical shock. Contact FUJIFILM Sonosite or your local representative for a list of accessories and peripherals available from or recommended by FUJIFILM Sonosite.
- Do not disassemble or alter the stand battery.
- Do not open the battery enclosure on the stand battery and housing.



WARNING

- To avoid the risk of electrical shock and fire hazard:
 - Inspect the AC power cords, cables, and plugs on a regular basis. Ensure that they are not damaged.
 - The power cord set that connects the power supply of the ultrasound system or the stand to mains power must only be used with the system, and cannot be used to connect other devices to mains power.
- To prevent injury to the operator/bystander, the transducer must be removed from patient contact before the application of a high-voltage defibrillation pulse.
- Because the only method of completely removing AC power from the stand is to disconnect the AC input power cord from the stand base, ensure that you place the stand in a location in which you can easily remove the AC input power cord if necessary.
- Failures in the electrical safety design of connected devices may result in a voltage on the ultrasound system. To minimize the risk of electrical shock to the patient and/or operator:
 - Use medical-grade devices.
 - After connections are made, test the electrical safety utilizing biomedical department electrical safety procedures.
- Under certain conditions, the area where the system docks to the stand may become hot to the touch. Use caution when handling.



CAUTION

- Do not use the system if an error message appears on the image display: note the error code; call FUJIFILM Sonosite or your local representative; turn off the system by pressing and holding the power key until the system powers down.
- To avoid increasing the system and transducer connector temperature, do not block the airflow to the ventilation openings on the front and back of the system.
- If the system overheats, it will shut down automatically.



NOTE

A potential equalization terminal compliant with IEC 60601-1, subclause 8.6.7 is provided at the base of the system to be used in situations where potential equalization bonding is required at the site of installation.

Electrical safety classification

Class I equipment	The ultrasound system is classified as Class 1 equipment when powered from the external power supply or mounted on the stand because the external power supply is a Class 1 protectively earthed power supply.
Internally powered equipment	The ultrasound system is classified as internally powered equipment when it is powered by internal battery (not connected to AC power).
Type BF applied parts	Ultrasound transducers
Ingress protection IPX0	Ultrasound system
Ingress protection IPX7	Ultrasound transducers
Non AP/APG	Ultrasound system including power supply, stand elements, and connected peripherals is not suitable for use in the presence of flammable anaesthetic mixture with air or oxygen or nitrous oxide.
Mode of operation	Continuous

Isolating the ultrasound system from power

The Sonosite ST ultrasound system does not become completely isolated from power by pressing the power button. Use the following procedure to completely isolate the system (including the stand) from power.

1. Press the power button.
2. Listen for the audio tone.



CAUTION

Unplugging the AC power cord before you hear the tone may result in loss of data. If you don't hear a tone, then your system may be set up to mute all sounds. To reinstate sounds, see [Adjusting audio settings \[42\]](#).

3. If the system is connected to AC power, unplug the AC power cord from the mains outlet.
4. Disconnect any devices attached to the system ports, including transducers.
5. Remove the system from the stand (see [Removing or installing the Sonosite ST system \[13\]](#)).
6. Remove the clinical monitor and the monitor mount and tray assembly.
7. Remove the batteries (see [Installing or replacing system batteries \[16\]](#)).
8. Disconnect the stand battery from power by unscrewing and pulling out the power cables from the battery pack.

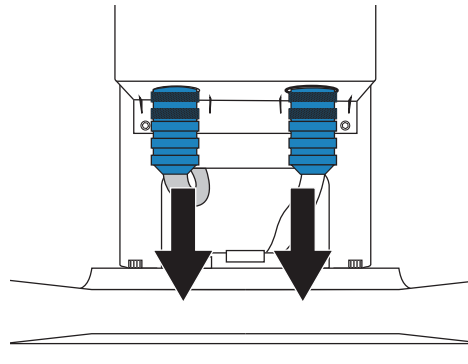
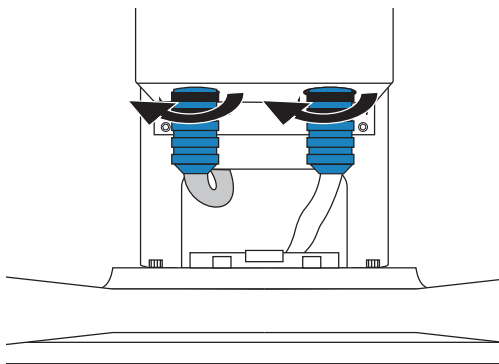

Equipment safety

To protect your ultrasound system, transducer, and accessories, follow these precautions.



WARNING

When transporting your system, to avoid possible injury from the system tipping, always lower the clinical monitor and push forward on the stand handle instead of pushing downward on the handle or pushing the clinical monitor.



CAUTION

- Excessive bending or twisting of cables can cause a failure or intermittent operation.
- Improper cleaning or disinfecting of any part of the system can cause permanent damage. For cleaning and disinfecting instructions, see [Cleaning and Disinfecting \[156\]](#).
- Do not submerge the transducer connector in solution. The cable is not liquid-tight beyond the transducer connector/cable interface.
- Do not use solvents such as thinner or benzene, or abrasive cleaners on any part of the system.
- Do not spill liquid on the system.
- Position the system to allow access to the mains power-cord connector.

Battery safety

To prevent the batteries from bursting, igniting, or emitting fumes and causing personal injury or equipment damage, observe the following precautions.



WARNING

- The battery has a safety device. Do not disassemble or alter the battery.
- Charge the batteries only when the ambient temperature is between 0° and 40°C (32° and 104°F).
- Do not short-circuit the battery by directly connecting the positive and negative terminals with metal objects.
- Do not touch battery contacts.
- Do not heat the battery or discard it in a fire.
- Do not expose the battery to temperatures over 60°C (140°F). Keep it away from fire and other heat sources.
- Do not charge the battery near a heat source, such as a fire or heater.
- Do not leave the battery in direct sunlight.
- Do not pierce the battery with a sharp object, hit it, or step on it.
- Do not use a damaged battery.
- Do not solder a battery.
- The polarity of the battery terminals are fixed and cannot be switched or reversed. Ensure that the batteries are in the correct orientation.
- Do not connect the battery to an electrical power outlet.
- Do not continue recharging the battery if it does not recharge after two successive six hour charging cycles. Replace the battery.
- Do not ship a damaged battery without instructions from FUJIFILM Sonosite Technical Support.
- If the battery leaks or emits an odor, remove it from all possible flammable sources.



CAUTION

- Do not immerse the battery in water or allow it to get wet.
- Do not put the battery into a microwave oven or pressurized container.
- If the battery emits an odor or heat, is deformed or discolored, or in any way appears abnormal during use, recharging or storage, immediately remove it and stop using it. If you have any questions about the battery, consult FUJIFILM Sonosite or your local representative.
- Use only FUJIFILM Sonosite batteries.
- Periodically, check to make sure that the battery charges fully. If the battery fails to charge fully, replace it.
- Do not use or charge the battery with non-FUJIFILM Sonosite equipment. Only charge the system battery with the system.
- The batteries contain technology that requires periodic recharging to maintain optimal performance. If left uncharged for months, battery performance could degrade or the battery could become non-functional.
- To prevent the stand battery from draining, do not connect the battery's DC output cable to its own or another stand battery DC input connector.
- To prevent damage to the system or batteries, do not install mismatched battery packs in the system. Verify that the battery packs have matching part numbers.

Clinical safety



WARNING

- To avoid injury, inspect all fasteners and connections.
- FUJIFILM Sonosite does not recommend the use of high-frequency electromedical devices in proximity to its systems. FUJIFILM Sonosite equipment has not been validated for use with high-frequency electrosurgical devices or procedures. Use of high-frequency electrosurgical devices in proximity to its systems may lead to abnormal system behavior or shutdown of the system. To avoid the risk of a burn hazard, do not use the transducer with high frequency surgical equipment. Such a hazard may occur in the event of a defect in the high frequency surgical neutral electrode connection.
- The maximum temperature of the transducer scan head may be greater than 41°C (105.8°F), but is less than 43°C (109.4°F) when in contact with the patient. Special precautions should be considered when using the transducer on children or on other patients who are sensitive to higher temperatures.
- Do not use the system if it exhibits erratic or inconsistent behavior. Discontinuities in the scanning sequence are indicative of a hardware failure that must be corrected before use.



WARNING

- Some transducer sheaths contain natural rubber latex and talc, which can cause allergic reactions in some individuals. FUJIFILM Sonosite recommends identifying your latex- and talc-sensitive patients and being prepared to treat allergic reactions promptly.
- Perform ultrasound procedures prudently. Use the ALARA (as low as reasonably achievable) principle and follow the prudent use information concerning MI and TI.
- FUJIFILM Sonosite does not currently recommend a specific brand of acoustic standoff. If an acoustic standoff is used, it must have a minimum attenuation of 0.3dB/cm/MHz.
- Use market-cleared, sterile transducer sheaths and sterile coupling gel for transrectal, transvaginal, or guided-needle procedures. Do not apply the transducer sheath and coupling gel until you are ready to perform the procedure. After use, remove and discard the single-use sheath, and clean and disinfect the transducer using a FUJIFILM Sonosite recommended disinfectant.
- To avoid applying unsafe voltage levels to the patient while a device is connected to the digital video out port, do not touch the ultrasound system and the patient simultaneously. Check the electrical safety of your system with a trained biomedical engineer.
- To avoid injury or reduce the risk of infection to the patient, observe the following:
 - Follow Universal Precautions when inserting and maintaining a medical device for interventional procedures.
 - Appropriate training in interventional procedures as dictated by current relevant medical practices as well as in proper operation of the ultrasound system and transducer is required. During vascular access, the potential exists for serious complications including without limitation the following: pneumothorax, arterial puncture, and guidewire misplacement.

Hazardous materials



WARNING

Products and accessories may contain hazardous materials. When disposing of products and accessories, be environmentally responsible and meet federal and local regulations for disposing hazardous materials.

Electromagnetic compatibility

The ultrasound system has been tested, evaluated, and verified to comply with the electromagnetic compatibility limits for medical devices to IEC 60601-1-2:2014 (Edition 4.0), IEC 60601-1-2:2014+A1:2020 (Edition 4.1), and IEC TR 60601-4-2:2016 (Edition 1.0). The

ultrasound system is suitable for use in the professional healthcare facility environment except for near active high frequency surgical equipment or in a RF shielded room where magnetic resonance imaging is performed because both produce high electromagnetic disturbances which could result in performance disruption of the ultrasound system. These limits are designed to provide reasonable protection against harmful interference in a typical medical installation.



WARNING

To avoid the risk of increased electromagnetic emissions or decreased immunity, use only accessories and peripherals recommended by FUJIFILM Sonosite. Connection of accessories and peripherals not recommended by FUJIFILM Sonosite could result in malfunctioning of your ultrasound system or other medical electrical devices in the area. Contact FUJIFILM Sonosite or your local representative for a list of accessories and peripherals available from or recommended by FUJIFILM Sonosite. See [Compatible accessories and peripherals \[182\]](#).



CAUTION

The EMC performance of the ultrasound system may be degraded if the product is used in harsh environments where the system is exposed to high humidity, elevated temperatures, high vibration, or high shock for extended durations. If the system shows symptoms of degraded EMC performance, see the precautions listed in the following section. If, after taking the listed precautions, the degraded EMC performance persists, the system may need to be serviced to maintain optimum EMC performance.



CAUTION

Medical electrical equipment requires special precautions regarding EMC and must be installed and operated according to these instructions. It is possible that high levels of radiated or conducted radio-frequency (RF) electromagnetic interference (EMI) from portable and mobile RF communications equipment or other strong or nearby radio-frequency sources, could result in performance disruption of the ultrasound system. Evidence of disruption may include image degradation or distortion, erratic readings, equipment ceasing to operate, or other incorrect functioning. If this occurs, survey the site to determine the source of disruption, and take the following actions to eliminate the sources.

- Turn equipment in the vicinity off and on to isolate disruptive equipment.
- Relocate or re-orient interfering equipment.
- Increase distance between interfering equipment (or equipment being interfered with) and your ultrasound system.
- Connect the ultrasound equipment and the interfering equipment (or equipment being interfered with) to different power outlet circuits.
- Manage use of frequencies close to ultrasound system frequencies.
- Remove devices that are highly susceptible to EMI.
- Lower power from internal sources within facility control (such as paging systems).
- Label devices susceptible to EMI.
- Educate clinical staff to recognize potential EMI-related problems.
- Eliminate or reduce EMI with technical solutions (such as shielding).
- Restrict use of personal communicators (cell phones, computers) in areas with devices susceptible to EMI.
- Share relevant EMI information with others, particularly when evaluating new equipment purchases which may generate EMI.
- Purchase medical devices that comply with IEC 60601-1-2 EMC standards.
- Do not stack other equipment on the ultrasound system or use other equipment in close proximity and adjacent to the ultrasound system. If stacking or using other equipment in close proximity is unavoidable, then you must observe the system to verify normal operation.

Wireless transmission

The ultrasound system contains an internal IEEE 802.11 transmitter that uses the Industrial, Scientific, and Medical (ISM) frequency bands from 2.412 to 2.484 GHz and/or 5.15 to 5.825 GHz. The transmitter supports the 802.11 a/b/g/n/ac wireless communication protocol (five different methods of transmission):

- IEEE 802.11a (5.150 to 5.850GHz) with Orthogonal Frequency Division Multiplexing (OFDM) at 12dBm +/- 2 dBm @ 54 Mbps
- IEEE 802.11ac (5.150 to 5.850GHz) with Orthogonal Frequency Division Multiplexing (OFDM) at 17dBm +/- 2 dBm @ MCS 0
- IEEE 802.11b with Direct Sequence Spread Spectrum (DSSS) at 16 dBm +/- 2 dBm @ 11 Mbps

- IEEE 802.11g with Orthogonal Frequency Division Multiplexing (OFDM) at 12 dBm +/- 2 dBm @54 Mbps
- IEEE 802.11n with Orthogonal Frequency Division Multiplexing (OFDM) at 12 dBm +/- 2 dBm @65 Mbps

**NOTE**

This device is in compliance with the essential requirements and other relevant provisions of Directive 2014/53/EU, the FCC, and Industry Canada.

Electrostatic discharge

**WARNING**

Unless following ESD precautionary procedures, do not connect to or touch (with body or hand-held tools) pins (contacts) of connectors that have the ESD Sensitive Devices label.

**CAUTION**

Electrostatic discharge (ESD), or static shock, is a naturally occurring phenomenon. ESD is common in conditions of low humidity, which can be caused by heating or air conditioning. ESD is a discharge of the electrical energy from a charged body to a lesser or non-charged body. The degree of discharge can be significant enough to cause damage to a transducer or an ultrasound system. The following precautions can help reduce ESD: anti-static spray on carpets, anti-static spray on linoleum, and anti-static mats.

Figure 14. Connectors with the electrostatically-sensitive devices label

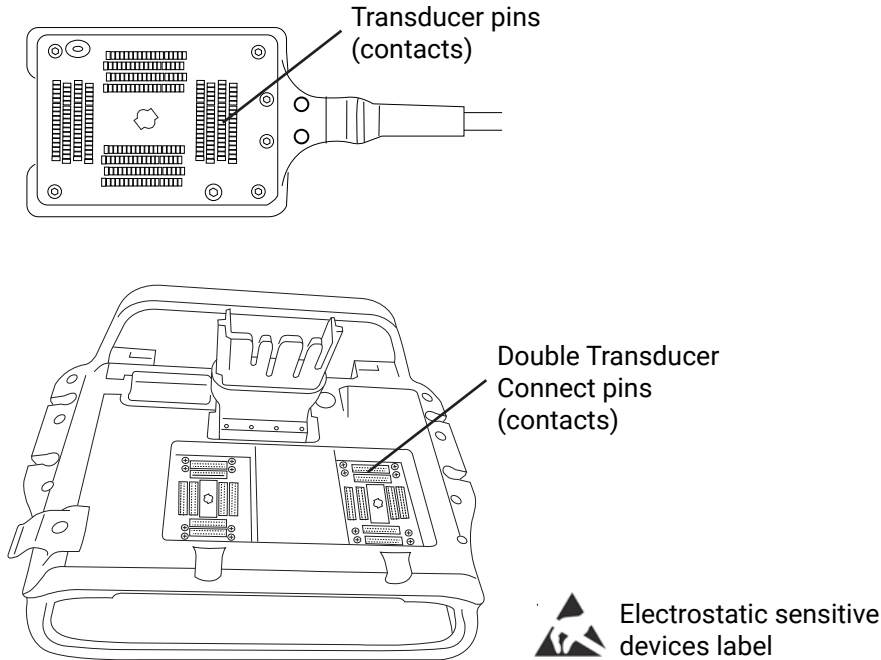

ESD precautionary procedures include the following:

- All staff involved must receive training about ESD, including the following at a minimum: an explanation of the ESD warning symbol, ESD precautionary procedures, an introduction to the physics of electrostatic charge, the voltage levels that can occur in normal practice, and the damage that can occur to electronic components if equipment is touched by an individual who is electrostatically charged.
- Prevent the buildup of electrostatic charge. For example, use humidification, conductive floor coverings, non-synthetic clothing, ionizers, and minimizing insulating materials.
- Discharge your body to earth.
- Use a wrist strap to bond yourself to the ultrasound system or to earth.

Separation distance

Recommended separation distances between portable and mobile RF communications equipment and the Sonosite ST ultrasound system



WARNING

Portable RF communications equipment (including peripherals, such as antenna cables and external antennas) should be used no closer than 30 cm (12 inches) to any part of the ultrasound system, including cables specified by the manufacturer. Otherwise, degradation of the performance of this equipment could result.

The Sonosite ST ultrasound system is intended for use in an electromagnetic environment in which radiated radio frequency (RF) disturbances are controlled. The customer or the user

of the FUJIFILM Sonosite ultrasound system can help prevent electromagnetic interference by maintaining a minimum distance between portable and mobile RF communications equipment (transmitters) and the FUJIFILM Sonosite ultrasound system as recommended below, according to the maximum output power of the communications equipment.

Table 42. Separation distance according to frequency of transmitter (m)

Rated maximum output power of transmitter (Watts) ^a	150 kHz to 80 MHz $d=1.2 \sqrt{P}$	80 MHz to 800 MHz $d=1.2 \sqrt{P}$	800 MHz to 2.7 GHz $d=2.3 \sqrt{P}$
0.01	0.12	0.12	0.23
0.1	0.38	0.38	0.73
1	1.2	1.2	2.3
10	3.8	3.8	7.3
100	12	12	23

^aFor transmitters rated at a maximum output power not listed above, the recommended separation distance (d) in meters (m) can be estimated using the equation applicable to the frequency of the transmitter, where P is the maximum output power rating of the transmitter in watts (W) according to the transmitter manufacturer.

Compatible accessories and peripherals

FUJIFILM Sonosite has tested the Sonosite ST ultrasound system with the following accessories and peripherals and has demonstrated compliance to the requirements of IEC 60601-1-2:2014 and IEC 60601-1-2:2014+A1:2020. You may use these FUJIFILM Sonosite accessories and third-party peripherals with the Sonosite ST ultrasound system.



WARNING

- Use of the accessories with medical systems other than the Sonosite ST ultrasound system may result in increased emissions or decreased immunity of the medical system.
- Use of accessories, transducers and cables other than those specified or provided by FUJIFILM Sonosite could result in increased emissions or decreased electromagnetic immunity of this equipment and result in improper operation.

Table 43. Compatible accessories and peripherals

Description	Maximum cable length
C5-1 transducer	5.5 ft/1.7 m
C10-3 transducer	5.5 ft/1.7 m
IC10-3 transducer	5.5 ft/1.7 m
L12-3 transducer	5.5 ft/1.7 m
L13-6 transducer	5.5 ft/1.7 m
L15-4 transducer	5.5 ft/1.7 m
L19-5 transducer	5.5 ft/1.7 m
P5-1 transducer	6.0 ft/1.8 m
CIVCO Needle Guide Starter Kit, C5-1, Infiniti Plus	—
CIVCO Needle Guide Starter Kit and Bracket, C10-3, Infiniti Plus	—

Description	Maximum cable length
CIVCO Needle Guide Starter Kit, IC10-3	—
CIVCO Needle Guide Starter Kit, L12-3, Infiniti Plus	—
CIVCO Needle Guide Starter Kit, L15-4, Infiniti Plus	—
CIVCO Needle Guide Starter Kit, L19-5, Infiniti Plus	—
CIVCO Needle Guide Starter Kit, L19-5, Accusite	—
Aquasonic gel	—
Barcode scanner	4.8 ft/ 1.5 m
Batteries (2)	—
Stand battery	—
Stand	—
Stand platform	—
Stand AC power cord	10 ft/3.1 m
PowerPark (docking station and stand module)	—
Gel and wipe holders	—
Storage container	—
Ethernet cable	49.2 ft/15 m
USB flash memory (64 GB)	—
Black and white printer	—
Black and white printer power cord	18 in/0.45 m
Microphone	—
Microphone cable	9 in/0.2 m



NOTE

For transducers, maximum cable length is measured between the strain reliefs. The stated lengths do not include the lengths of cable in the following locations: underneath the strain reliefs, inside the transducer enclosure, or inside the transducer connector.

Manufacturer's declaration

The tables in this section document the intended use environment and EMC compliance levels of the system. For maximum performance, ensure that the system is used in the environments described in these tables.

The system is intended for use in the electromagnetic environment specified below.

Table 44. Manufacturer's Declaration - Electromagnetic Emissions per IEC 60601-1-2:2014 and IEC 60601-1-2:2014+A1:2020

Emissions test	Compliance	Electromagnetic environment
RF emissions CISPR 11	Group 1	The Sonosite ST ultrasound system uses RF energy only for its internal function. Therefore, its RF emissions are very low and are not likely to cause any interference in nearby electronic equipment.

Emissions test	Compliance	Electromagnetic environment
RF emissions CISPR 11	Class B	The Sonosite ST ultrasound system is suitable for use in all establishments, including domestic establishments and those directly connected to the public low-voltage power supply network that supplies buildings used for domestic purposes.
Harmonic emissions IEC 61000-3-2	Class A	—
Voltage fluctuations/flicker emissions IEC 61000-3-3	Complies	—

The system is intended for use in the electromagnetic environment specified below.

Table 45. Manufacturer's Declaration - Electromagnetic Immunity per IEC 60601-1-2:2014, IEC 60601-1-2:2014+A1:2020, and IEC TR 60601-1-2:2016

Immunity test	IEC 60601-1-2, IEC TR 60601-4-2 Test Level	Compliance level	Electromagnetic environment
Electrostatic discharge (ESD) IEC 61000-4-2	± 8.0 kV contact, ± 2.0 kV, ± 4.0 kV, ± 8.0 kV ± 15 kV air	± 8.0 kV contact, ± 2.0 kV, ± 4.0 kV, ± 8.0 kV ± 15 kV air	Floors should be wood, concrete or ceramic tile. If floors are covered with synthetic material, the relative humidity should be at least 30%.
Electrical fast transient burst IEC 61000-4-4	± 2 kV on the mains ± 1 kV on signal lines	± 2 kV on the mains ± 1 kV on signal lines	Mains power quality should be that of a typical commercial or hospital environment.
Surge IEC 61000-4-5	± 1 kV line(s) to line(s) ± 2 kV line(s) to earth	± 1 kV line(s) to line(s) ± 2 kV line(s) to earth	Mains power quality should be that of a typical commercial or hospital environment.
Voltage dips, short interruptions and voltage variations on power supply input lines IEC 61000-4-11	0% U_T for 0.5 cycle 0% U_T for 1 cycles 70% U_T (30% dip in U_T) for 500 msec <5% U_T (95% dip in U_T) for 5s	0% U_T for 0.5 cycle 0% U_T for 1 cycles 70% U_T (30% dip in U_T) for 500 msec <5% U_T (95% dip in U_T) for 5s	Mains power quality should be that of a typical commercial or hospital environment. If the user of the FUJIFILM Sonosite ultrasound system requires continued operation during power mains interruptions, it is recommended that the FUJIFILM Sonosite ultrasound system be powered from an uninterruptible power supply or a battery.
Power frequency magnetic field IEC 61000-4-8	30 A/m	30 A/m	If image distortion occurs, it may be necessary to position the FUJIFILM Sonosite ultrasound system further from sources of power frequency magnetic fields or to install magnetic shielding. The power frequency magnetic field should be measured in the Intended installation location to assure that it is sufficiently low.
Proximity Magnetic Fields IEC 61000-4-39 applicable for IEC 60601-1-2:2014+A1:2020 (Edition 4.1) only	Per 60601-1-2:2014+A1:2020 Table 11	Per 60601-1-2:2014+A1:2020 Table 11	If image distortion occurs, it may be necessary to position the FUJIFILM Sonosite ultrasound system further from sources of proximity magnetic fields or to install magnetic shielding. The proximity magnetic fields should be measured in the intended installation to assure they are sufficiently low.

Immunity test	IEC 60601-1-2, IEC TR 60601-4-2 Test Level	Compliance level	Electromagnetic environment
Conducted RF IEC 61000-4-6	3 Vrms 150 kHz to 80 MHz\ 6 Vrms in ISM bands	3 Vrms 6 Vrms in ISM bands	Portable and mobile RF communications equipment should be used no closer to any part of the FUJIFILM Sonosite ultrasound system including cables, than the recommended separation distance calculated from the equation applicable to the frequency of the transmitter. Recommended Separation Distance $d = 1.2 \sqrt{P}$
Radiated RF IEC 61000-4-3	3 V/m 80 MHz to 2.7 GHz	3 V/m 80 MHz to 2.7 GHz	$d = 1.2 \sqrt{P}$ 80 MHz to 800 MHz $d = 2.3 \sqrt{P}$ 800 MHz to 2,7 GHz Where P is the maximum output power rating of the transmitter in watts (W) according to the transmitter manufacturer and d is the recommended separation distance in meters (m). Field strengths from fixed RF transmitters, as determined by an electromagnetic site survey ^a , should be less than the compliance level in each frequency range ^b . Interference may occur in the vicinity of equipment marked with the following symbol:  (IEC 60417 No. 417-IEC-5140: "Source of non-ionizing radiation")
Proximity fields from wireless communications equipment IEC 61000-4-3	Per 60601-1-2:2014 and IEC 60601-1-2:2014+A1 :2020 Table 9	Per 60601-1-2:2014 and IEC 60601-1-2:2014+A1 :2020 Table 9	—

^aField strengths from fixed transmitters such as base stations for radio (cellular/cordless) telephones and land mobile radios, amateur radio, AM and FM radio broadcast and TV broadcast cannot be predicted theoretically with accuracy. To assess the electromagnetic environment due to fixed RF transmitters, an electromagnetic site survey should be considered. If the measured field strength in the location in which the FUJIFILM Sonosite ultrasound system is used exceeds the applicable RF compliance level above, the FUJIFILM Sonosite ultrasound system should be observed to verify normal operation. If abnormal performance is observed, additional measures may be necessary, such as re-orienting or relocating the FUJIFILM Sonosite ultrasound system.

^bOver the frequency range 150 kHz to 80 MHz, field strengths should be less than 3 V/m.

Essential performance requirements

Per 60601-2-37, the following have been determined to be essential performance for the Sonosite ST ultrasound system. The Sonosite ST ultrasound system must be free from the following:

- Noise on a waveform or artifacts or distortion in an image or error of a displayed numerical value that cannot be attributed to a physiological effect and that may alter the diagnosis
- Display of incorrect numerical values associated with the diagnosis to be performed
- Display of incorrect safety related indications
- Production of unintended or excessive ultrasound output
- Production of unintended or excessive transducer assembly surface temperature
- Production of unintended or uncontrolled motion of transducer assemblies intended for intracorporeal use

Results of EMC immunity testing show that the Sonosite ST ultrasound system meets the essential performance requirements in 60601-2-37. If the operator detects unacceptable degradation of performance, they should stop using the equipment and take suitable precautions as detailed in [Electromagnetic compatibility \[177\]](#).

IEC TR 60601-4-2 Acceptable Degradation of Performance

Degradation of Performance During Immunity Test: Degradation is allowed. Essential performance may be affected but in a way that would not affect diagnosis. Diagnosis may be delayed if essential performance is affected in a way that prevents immediate diagnosis.

Degradation of Performance After Immunity Testing: No degradation is allowed. The ultrasound system and accessories must meet all functional and safety tests.

The Sonosite ST ultrasound system was tested according to the recommendations of IEC TR 60601-4-2: Medical Electrical Equipment - Part 4-2: Guidance and interpretation - Electromagnetic Immunity Performance of Medical Electrical Equipment and Medical Electrical Systems. Results of EMC immunity testing show that the Sonosite ST ultrasound system meets the performance requirements per IEC TR 60601-4-2. If the operator detects unacceptable degradation of performance, they should stop using the equipment and take suitable precautions as detailed in [Electromagnetic compatibility \[177\]](#).



The maximum recovery time for most transient immunity tests (Electrical Fast Transients/Burst, Surges, Voltage Dips (0%)) is 1 second or less. The maximum recovery time for Electrostatic Discharge is 3 seconds or less.











FCC Caution: This equipment has been tested and found to comply with the limits for a Class B digital device, pursuant to part 15 of the FCC Rules. These limits are designed to provide reasonable protection against harmful interference in a residential installation. This equipment generates, uses and can radiate harmful radio frequency energy and, if not installed and used in accordance with the instructions, may cause harmful interference to radio communications. However, there is no guarantee that interference will not occur in a particular installation. If this equipment does cause harmful interference to other medical or electronic equipment, take suitable precautions as detailed in [Electromagnetic compatibility \[177\]](#).









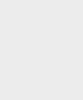



Labeling symbols















The following symbols are used on the products, packaging, and containers.













Table 46. Standards labeling symbols

Symbol	Description	Standards reference
	Manufacturer Indicates the medical device manufacturer	ISO 15223-1 Medical devices – symbols to be used with medical device labels, labeling, and information to be supplied – Part 1: General requirements 5.1.1
	Date of manufacture Indicates the date on which a product was manufactured	ISO 7000- Graphical symbols for Use on Equipment 5.1.3
	Serial Number Indicates the manufacturer's serial number so that a specific medical device can be identified	ISO 15223-1 Medical devices – symbols to be used with medical device labels, labeling, and information to be supplied – Part 1: General requirements 5.1.7

Symbol	Description	Standards reference
	Catalog Number Indicates the manufacturer's catalogue number so that the medical device can be identified	ISO 15223-1 Medical devices – symbols to be used with medical device labels, labeling, and information to be supplied – Part 1: General requirements 5.1.6
	Caution Indicates that caution is necessary when operating the device or control close to where the symbol is placed	ISO 15223-1 Medical devices – symbols to be used with medical device labels, labeling, and information to be supplied – Part 1: General requirements 5.4.4
	Fragile handle with care Indicates a medical device that can be broken or damaged if not handled carefully	ISO 15223-1 Medical devices – symbols to be used with medical device labels, labeling, and information to be supplied – Part 1: General requirements 5.3.1
	Keep dry Indicates a medical device that needs to be protected from moisture	ISO 15223-1 Medical devices – symbols to be used with medical device labels, labeling, and information to be supplied – Part 1: General requirements 5.3.4
	Temperature limit Indicates the temperature limits to which the medical device can be safely exposed	ISO 15223-1 Medical devices – symbols to be used with medical device labels, labeling, and information to be supplied – Part 1: General requirements 5.3.7
	Atmospheric pressure limitations Indicates the range of atmospheric pressure to which the medical device can be safely exposed	ISO 15223-1 Medical devices – symbols to be used with medical device labels, labeling, and information to be supplied – Part 1: General requirements 5.3.9
	Humidity limitation Indicates the range of humidity to which the medical device can be safely exposed	ISO 15223-1 Medical devices – symbols to be used with medical device labels, labeling, and information to be supplied – Part 1: General requirements 5.3.8
	Stacking limit by number Do not stack over n high, where n represents the number on the label	ISO 7000 Graphical symbols for use on equipment 2403
	Refer to instruction manual/booklet	IEC 60601-1 Medical electrical equipment Part 1: General requirements for basic safety and essential performance D.2-10
	Consult instructions for use Indicates that the operating instructions should be considered when operating the device or control close to where the symbol is placed	ISO 15223-1 Medical devices – symbols to be used with medical device labels, labeling, and information to be supplied – Part 1: General requirements 5.4.3
	Non-ionizing electromagnetic radiation To indicate generally elevated, potentially hazardous, levels of non-ionizing radiation, or to indicate equipment or systems e.g. in the medical electrical area that include RF transmitters or that intentionally apply RF electromagnetic energy for diagnosis or treatment	IEC 60417 Graphical symbols for use on equipment 5140

Symbol	Description	Standards reference
	Corrugated recycle Shipping box is made of corrugated cardboard and should be recycled accordingly	—
	FCC—Tested to Federal Communications Commission requirements. Device complies with relevant FCC regulations for electronic devices.	Federal Communications Commission (FCC) Declaration of conformity 21 Part 15
	IC—Tested to Industry Canada requirements. Device complies with relevant IC regulations for electronic devices.	—
	RESY – Recycling Symbol Paper recycle	—
	Recycle: Electronic Equipment Do Not Throw in Trash	BS EN 50419 Marking of Electrical and Electronic Equipment in accordance with Directive 2012/19/EU for the Waste of Electrical and Electronic Equipment (WEEE) and Directive 2006/66/EC on Batteries and Accumulators and Waste Batteries and Accumulators Annex IX
	CE Marking Signifies European Technical Conformity	—
	Conformité Européene Notified Body Reference No.: 2797 Indicates European technical conformity and identification of notified body responsible for implementation of the procedures set out in Annexes II, IV, V, and VI	—
	UK Conformity Assessed Mark that indicates conformity with the applicable requirements for products sold within Great Britain	The Product Safety and Metrology etc. (Amendment etc.) (EU Exit) Regulations 2019
	UK Conformity Assessed with approved body number Mark, including the approved body number, that indicates conformity with the applicable requirements for products sold within Great Britain	The Product Safety and Metrology etc. (Amendment etc.) (EU Exit) Regulations 2019
	Indicates the Authorized representative in the European Community	ISO 15223-1 Medical devices - symbols to be used with medical device labels, labeling and information to be supplied 5.1.2
	Medical Device Indicates the item the label is adhered to is categorized as a medical device per the MDR, Annex 1, 23.2, q.	EU MDR Annex I, 23.2 (q)
	UDI Unique device identifier. This symbol is optional and is used when there are multiple data carriers on a label.	ISO 15223-1:2021 5.7.10
	Regulatory Compliance Mark (RCM) Indicates C-Tick-Regulatory Compliance Mark for Australia and New Zealand. Device complies with relevant Australian and New Zealand regulations for electronic devices.	AS/NZS3820

Symbol	Description	Standards reference
	Alternating current Indicates on the rating plate, that the equipment is suitable for alternating current only, in order to identify appropriate terminals	IEC 60601-1
	Direct current (DC) To indicate on the rating plate that the equipment is suitable for direct current only; to identify relevant terminals.	IEC 60601-1
	Batch code, date code, or lot code type of control number Indicates manufacturer's batch code so that the batch or lot can be identified	ISO 15223-1 Medical devices - Symbols to be used with medical device labels, labeling and information to be supplied - Part 1: General Requirements 5.1.5
	Biological risk To warn of biological hazard	ISO 7010 - Graphical symbols -- Safety colors and safety signs W009
	Canadian Standard Association Certification Mark CSA certification mark signifying that the product complies with the applicable CSA and ANSI/UL requirements and is authorized for use in Canada and the US	—
	ETL (electronic Testing Laboratories) certification mark Proof product complies to North American safety standards	—
	TUV Rhineland of North America. The "C" and "US" indicators signify that the product has been evaluated to the applicable CSA and ANSI/UL standards for use in Canada and the United States, respectively.	—
	UL certification UL recognized component mark for Canada and The United States	—
	UL certification with registration number UL recognized component mark for Canada and The United States with registration number	—
	Electrostatic sensitive devices Indicates packages containing electrostatic sensitive devices, or identifies a device or a connector that has not been tested for immunity to electrostatic discharge	IEC 60417: Graphical Symbols For Use On Equipment 5134
	Magnetic resonance environment unsafe Indicates the system is an item that is known to pose hazards in all MR environments	ASTM International (American Society for Testing and Materials) ASTM F2503
	Indicates a medical device that has been sterilized using irradiation	ISO 15223-1 Medical devices - Symbols to be used with medical device labels, labeling and information to be supplied - Part 1: General Requirements 5.2.4
	Indicates a medical device that has been sterilized using ethylene oxide	ISO 15223-1 Medical devices - Symbols to be used with medical device labels, labeling and information to be supplied - Part 1: General Requirements 5.2.3
	Caution hot Indicates that the marked item can be hot and should not be touched without taking care	ISO 7000 / IEC 60417 Graphical symbols for use on equipment 5041

Symbol	Description	Standards reference
	Caution, static magnetic field hazard Identifies areas with potentially hazardous static magnetic fields and forces in an installation	ISO 7000 / IEC 60417 Graphical symbols for use on equipment 6204
	Degree of ingress protection provided by enclosure Protected against the effects of temporary immersion in water	IEC 60601-1 Medical electrical equipment Part 1: General requirements for basic safety and essential performance D.3-2
	Indicates handle with care	—
	Indicates follow manufacturer's instructions for disinfecting time	—
	Indicates disinfect transducer	—
	Do not push To avoid tipping, do not move the system using the handle on the front of the ultrasound system	—
	Type BF applied parts Identifies type BF applied part complying with IEC 60601-1	IEC 60601-1 Medical electrical equipment Part 1: General requirements for basic safety and essential performance D.1-20
	Defibrillation- proof type CF applied part Identifies a defibrillation-proof type CF applied part complying with IEC 60601-1	IEC 60601-1 Medical electrical equipment Part 1: General requirements for basic safety and essential performance D.1-27
	China Pollution Control (10) Pollution Control Logo. (Applies to all parts/products listed in the China RoHS disclosure table. May not appear on the exterior of some parts/products because of space limitations.)	Ministry of Industry and Information Technology
	China Compulsory Certificate mark ("CCC Mark") A compulsory safety mark for compliance to Chinese national standards for many products sold in the People's Republic of China	—
	Identifies potential equalization terminal	IEC 60601-1 Medical Electrical Equipment Part 1: General requirements for basic safety and essential performance D.1-8
	Indicates total weight of the equipment, including the safe working load	IEC 60601-1 Medical Electrical Equipment Part 1: General requirements for basic safety and essential performance 7.2.21

Specifications

For information on accessories and peripherals, see [Compatible accessories and peripherals \[182\]](#).

Dimensions

System

- Storage bin capacity: 5 kg

- Stand depth: 25.4 in. (64.5 cm)
- Stand width: 23.0 in. (58.4 cm)
- Height range: max with monitor up 68 in. (172.6 cm); min with monitor back 53.75 in. (136.5 cm)
- Weight: 150.6 lbs. (68.3 kg) with the L15-4 transducer and battery installed

Stand battery

- Length: 19 in. (48.26 cm)
- Width: 4 in. (10.16 cm)
- Depth: 2.2 in. (5.59 cm)
- Weight: 6 lbs (2.72 kg)

Display

- Width: 12.75 in. (32,4 cm)
- Height: 17 in. (43.2 cm)
- Diagonal: 21.3 in. (54.1 cm)
- Resolution: 1600 x 1200 px

Environmental limits

Table 47. Operating limits

Limit type	System, batteries, transducers, and stand
Temperature	0–40°C (32–104°F)
Humidity	15–95% R.H.
Atmospheric pressure	700–1060 hPa (0.69–1.05 ATM)

Table 48. Shipping limits

Limit type	System (no batteries), transducers, and stand head/platform	System batteries and stand with stand battery
Temperature	-35–65°C (-31–149°F)	-20–60°C (-4–140°F)
Humidity	15–95% R.H.	15–95% R.H.
Atmospheric pressure	500–1060 hPa (0.5–1.05 ATM)	500–1060 hPa (0.5–1.05 ATM)

Table 49. Storage limits

Limit type	System (no batteries), transducers, and stand head/platform	System and stand batteries
Temperature	-35–65°C (-31–149°F)	-20–60°C (-4–140°F) for 1 month; -20–45°C (-4–113°F) for 3 months; -20–23°C (-4–73°F) for 1 year
Humidity	15–95% R.H.	15–95% R.H.
Atmospheric pressure	500–1060 hPa (0.5–1.05 ATM)	500–1060 hPa (0.5–1.05 ATM)



NOTE

For long term storage of lithium batteries, contact FUJIFILM Sonosite for additional information. To store the batteries for long periods of time, remove the system batteries from the system and remove the system from the stand. Charge all batteries periodically to maintain optimal performance.

Electrical rating

Stand

- Input: 100–240 VAC, 50–60 Hz, 6.0–2.5 A
- Output: 100–240 VAC, 50–60 Hz, 2.5–1.0 A



NOTE

Only connect the printer that comes with the system to the output.

Stand battery

- 21.6 VDC, 12000 mAh, 259.2 Wh
- Input: 26.7 VDC, 9.36 A (max 250 W)
- Output: 26.7 VDC, 9.36 A (max 250 W) from power supply or 21.6 VDC, 12000 mAh, 259.2 Wh from battery



NOTE

The stand battery is supplied from the system AC/DC power supply.

Batteries

Each battery pack contains six lithium-ion cells connected in 6S x 1P configuration, an internal protection circuit, temperature sensor and an output connector. Each ultrasound system contains two battery packs. The run time using both batteries is up to one hour, depending on imaging modes and display brightness.

The stand battery contains four battery packs of the same type. The total run time using both system and stand batteries is up to three hours, depending on the imaging modes and display brightness.

Imaging modes

- 2D (256 gray shades)
- Color Doppler (Color) (256 colors)
- Color Power Doppler (CPD) (256 colors)

- M Mode
- Pulsed wave (PW) Doppler
- Continuous wave (CW) Doppler

Additionally, the system includes advanced imaging technologies:

- Tissue Doppler Imaging (TDI)
- Tissue Harmonic Imaging (THI)

Image and video clip storage capacity

The number of images and video clips you can save depends on imaging mode and file format.

Standards

Electromechanical safety standards

Standard	Description
ANSI/AAMI ES60601-1:2005 + A1:2012 + A2:2021	Medical electrical equipment, Part 1: General requirements for basic safety and essential performance (Edition 3.2)
CAN/CSA C22.2 No. 60601-1:14 (R2022)	Medical electrical equipment - Part 1: General Requirements for Basic Safety and Essential Performance (Edition 3.2)
CSA C22.2 60601-2-37:08 (R2019)	Medical Electrical Equipment - Part 2-37: Particular requirements for the basic safety and essential performance of ultrasonic medical diagnostic and monitoring equipment (Adopted IEC 60601-2-37+A1:2015)
CSA C22.2 60601-1-6:11 (+A1:2015 +A2:2021)	Medical Electrical Equipment Part 1-6: General requirements for basic safety and essential performance - Collateral Standard: Usability (Adopted IEC 60601-1-6:2020, Edition 3.2)
IEC 60601-1:2020 Ed. 3.2	Medical electrical equipment - Part 1: General Requirements for Basic Safety and Essential Performance (Edition 3.2)
IEC 60601-2-37:2007 +A1:2015 Ed. 2.1	Medical Electrical Equipment - Part 2-37: Particular requirements for the basic safety and essential performance of ultrasonic medical diagnostic and monitoring equipment (Edition 2.1)
IEC 60601-1-6:2020 Ed. 3.2	Medical Electrical Equipment Part 1-6: General requirements for basic safety and essential performance - Collateral Standard: Usability (Edition 3.2)

EMC standards classification

Standard	Description
IEC 60601-1-2:2014	Medical Electrical Equipment. General Requirements for Basic Safety and Essential Performance-Collateral Standard. Electromagnetic Compatibility. Requirements and Tests.
IEC 60601-1-2:2014+A1:2020	Medical Electrical Equipment. General Requirements for Basic Safety and Essential Performance-Collateral Standard. Electromagnetic Compatibility. Requirements and Tests.

DICOM standards

Digital Imaging and Communications in Medicine (DICOM), Version 3.1, 2007 (NEMA).

The system conforms to the DICOM standard as specified in the Sonosite ST DICOM Conformance Statement, available at www.sonosite.com. This statement provides information about the purpose, characteristics, configuration, and specifications of the network connections supported by the system.

Security and privacy standards

The system includes security settings that help you to meet the applicable security requirements listed in the HIPAA standard. Users are ultimately responsible for ensuring the security and protection of all electronic protected health information collected, stored, reviewed, and transmitted on the system.

Standard	Description
HIPAA:1996	45 CFR Parts 160 and 164; Subparts A, C, and E, Health Insurance Portability and Accountability Act (HIPAA) Privacy and Security Rules
NIST SP 800-53:	Security and Privacy Controls for Federal Information Systems and Organizations

Acoustic Output

This section contains information about the ALARA (as low as reasonably achievable) principle, the output display standard, and acoustic power and intensity tables. The information applies to the ultrasound system, transducer, accessories, and peripherals.

ALARA principle

ALARA is the guiding principle for the use of diagnostic ultrasound. Qualified ultrasound users, using good judgment and insight, determine the exposure that is “as low as reasonably achievable.” There are no set rules to determine the correct exposure for every situation. The qualified ultrasound user determines the most appropriate way to keep exposure low and bioeffects to a minimum, while obtaining a diagnostic examination.

A thorough knowledge of the imaging modes, transducer capability, system setup and scanning technique is necessary. The imaging mode determines the nature of the ultrasound beam. A stationary beam results in a more concentrated exposure than a scanned beam, which spreads that exposure over that area. The transducer capability depends upon the frequency, penetration, resolution, and field of view. The default system presets are reset at the start of each new patient. It is the scanning technique of the qualified ultrasound user along with patient variability that determines the system settings throughout the exam.

The variables which affect the way the qualified ultrasound user implements the ALARA principle include patient body size, location of the bone relative to the focal point, attenuation in the body, and ultrasound exposure time. Exposure time is an especially useful variable, because the qualified ultrasound user can control it. The ability to limit the exposure over time supports the ALARA principle.

Applying the ALARA principle

The system imaging mode selected by the qualified ultrasound user is determined by the diagnostic information required. 2D imaging provides anatomical information; CPD imaging provides information about the energy or amplitude strength of the Doppler signal over time at a given anatomical location and is used for detecting the presence of blood flow; Color imaging provides information about the energy or amplitude strength of the Doppler signal over time at a given anatomical location and is used for detecting the presence, velocity, and direction of blood flow; Tissue Harmonic Imaging uses higher received frequencies to reduce clutter, artifact, and improve resolution on the 2D image. Understanding the nature of the imaging mode used allows the qualified ultrasound user to apply the ALARA principle.

Prudent use of ultrasound means limiting ultrasound to situations in which it is medically useful and limiting patient exposure to the lowest ultrasound output for the shortest time necessary to achieve acceptable diagnostic results. Users can directly control acoustic output as described in the next section. Decisions that support prudent use are based on the type of patient, exam type, patient history, ease or difficulty of obtaining diagnostically useful information, and potential localized heating of the patient due to transducer surface temperature. In the event of a device malfunction, there are redundant controls that limit transducer power. This is accomplished by an electrical design that limits both power supply current and voltage to the transducer.

The qualified ultrasound user uses the system controls to adjust image quality and limit ultrasound output. The system controls are divided into three categories relative to output: controls that directly affect output, controls that indirectly affect output, and receiver controls.

Direct, indirect, and receiver controls

Direct controls

The Power control allows the user to directly control the acoustic output. The qualified ultrasound user can vary the output level in 10% increments from 100% down to 10%. A direct correlation exists between the power setting and the mechanical index (MI) and thermal index (TI) output; reducing the power level causes a reduction in the MI and TI. However, there is not necessarily a linear correlation between the two. Therefore, it is up to the ultrasound user to adjust the power setting as needed to achieve a desired MI or TI for the current imaging state.

It should be understood that while the power setting persists across changes to image settings (e.g. depth, optimization, and THI), the MI and TI are not fixed and will likely change (increase or decrease) as a result of changes to the settings. Therefore, the power settings required to achieve a target MI or TI may be different for different imaging states. The system does not exceed a spatial peak temporal average intensity (ISPTA) of 720 mW/cm² for all imaging modes. The MI and TI may exceed values greater than 1.0 on some transducers in some imaging modes. For either the Ophthalmic or Orbital exam, the acoustic output is limited to the following values: ISPTA does not exceed 50 mW/cm²; TI does not exceed 1.0, and MI does not exceed 0.23. Ultrasound users can monitor the MI and TI values on the right side of the clinical monitor and implement the ALARA principle accordingly. For more information on MI and TI, see Medical Ultrasound Safety, AIUM and IEC 60601-2-37 Annex "Guidance on the interpretation of TI and MI to be used to inform the operator."

Indirect controls

The controls that indirectly affect output are controls affecting imaging mode, freeze, and depth. The imaging mode determines the nature of the ultrasound beam. Freeze stops all ultrasound output but keeps the last image displayed on screen. Freeze can be used by the ultrasound user to limit exposure time while studying an image and maintaining probe position during a scan. Some controls, such as depth, show a rough correspondence with output

Receiver controls

The receiver controls are the gain controls. Receiver controls do not affect output. They should be used, if possible, to improve image quality before using controls that directly or indirectly affect output.

Acoustic artifacts

An acoustic artifact is information, present or absent in an image, that does not properly indicate the structure or flow being imaged. There are helpful artifacts that aid in diagnosis and those that hinder proper interpretation. Examples of artifacts include shadowing, through transmission, aliasing, reverberations, and comet tails. For more information on detecting and interpreting acoustic artifacts, see the following reference:

Kremkau, Frederick W. Diagnostic Ultrasound: Principles and Instruments. 7th ed., W.B. Saunders Company, (Oct. 17, 2005).

Output display

The system meets the output display standard in IEC60601-2-37 for MI and TI (see [Related guidance documents \[198\]](#)). The system output display consists of two indices: the mechanical index and the thermal index. Both indices are continuously displayed over the range of <0.1 to the maximum output in increments of 0.1. The following table indicates for each transducer and

operating mode when either the TI or MI is greater than or equal to a value of 1.0, thus requiring reporting of maximum output values (see [Acoustic output tables \[201\]](#)).

Table 50. TI or MI \geq 1.0

Transducer	Index ^{a,b,c}	2D, M Mode	CPD/Color	PW Doppler	2D + PW	2D + PW + Color	CW Doppler
C5-1	MI	Yes	Yes	Yes	—	—	—
	TIC, TIB, or TIS	Yes	Yes	Yes	—	—	—
C10-3	MI	Yes	Yes	Yes	—	—	—
	TIC, TIB, or TIS	Yes	Yes	Yes	—	—	—
IC10-3	MI	No	No	No	—	—	—
	TIC, TIB, or TIS	No	No	No	—	—	—
L12-3	MI	Yes	Yes	Yes	Yes	Yes	—
	TIC, TIB, or TIS	Yes	Yes	Yes	Yes	Yes	—
L13-6	MI	Yes	Yes	No	Yes	Yes	—
	TIC, TIB, or TIS	No	No	Yes	Yes	Yes	—
L15-4	MI	Yes	Yes	Yes	Yes	Yes	—
	TIC, TIB, or TIS	No	Yes	Yes	Yes	Yes	—
L19-5	MI	Yes	Yes	No	Yes	Yes	—
	TIC, TIB, or TIS	Yes	Yes	Yes	Yes	Yes	—
P5-1	MI	Yes	Yes	Yes	—	—	No
	TIC, TIB, or TIS	Yes	Yes	Yes	—	—	Yes

^aEven if MI is less than 1.0, the system provides a continuous real-time display of MI in all imaging modes, in increments of 0.1.

^bThe system meets the output display standard for TI and provides a continuous real-time display of TI in all imaging modes, in increments of 0.1.

^cThe TI consists of three user-selectable indices, and only one of these is displayed at any one time. In order to display TI properly and meet the ALARA principle, the user selects an appropriate TI based on the specific exam being performed. See the description of the Thermal Index control in [2D imaging controls \[69\]](#).

MI and TI output display accuracy

For each transducer, the accuracy of the displayed MI and TI are provided in the following table. The accuracy values are stated statistically as 95% tolerance interval limits and should be interpreted as follows: with 95% confidence, 95% of the measured MI/TI values are within the specified percentage of the displayed value or 0.1 of the displayed value, whichever is larger.

Table 51. MI and TI output display accuracy

Transducer	MI display accuracy	TI display accuracy
C5-1	+19% to -17%	+21% to -21%
C10-3	+19% to -19%	+26% to -21%
IC10-3	+15% to -22%	+19% to -37%
L12-3	+24% to -20%	+33% to -28%
L13-6	+18% to -23%	+21% to -33%
L15-4	+25% to -23%	+37% to -29%
L19-5	+21% to -26%	+38% to -47%
P5-1	+20% to -16%	+21% to -22%

A displayed value of 0.0 for MI or TI means that the calculated estimate for the index is less than 0.05.

Factors that contribute to display uncertainty

The net uncertainty of the displayed indices is derived by combining the quantified uncertainty from three sources: measurement uncertainty, system and transducer variability, and engineering assumptions and approximations made when calculating the display values.

Measurement errors of the acoustic parameters when taking the reference data are the major source of error that contributes to the display uncertainty. The measurement error is described in [Acoustic measurement precision and uncertainty \[255\]](#).

The displayed MI and TI values are based on calculations that use a set of acoustic output measurements that were made using a single reference ultrasound system with a single reference transducer that is representative of the population of transducers of that type. The reference system and transducer are chosen from a sample population of systems and transducers taken from early production units, and they are selected based on having an acoustic output that is representative of the nominal expected acoustic output for all transducer-system combinations that might occur. Of course every transducer-system combination has its own unique characteristic acoustic output, and will not match the nominal output on which the display estimates are based. This variability between systems and transducers introduces an error into displayed value. By doing acoustic output sampling testing during production, the amount of error introduced by the variability is bounded. The sampling testing ensures that the acoustic output of transducers and systems being manufactured stays within a specified range of the nominal acoustic output.

Another source of error arises from the assumptions and approximations that are made when deriving the estimates for the display indices. Chief among these assumptions is that the acoustic output, and thus the derived display indices, are linearly correlated with the transmit drive voltage of the transducer. Generally, this assumption is very good, but it is not exact, and thus some error in the display can be attributed to the assumption of voltage linearity.

Related guidance documents

Marketing Clearance of Diagnostic Ultrasound Systems and Transducers, FDA, 2019.

Medical Ultrasound Safety, American Institute of Ultrasound in Medicine (AIUM), 2014.

Acoustic Output Measurement Standard for Diagnostic Ultrasound Equipment, NEMA UD2-2004.

IEC 60601-2-37: 2015, "Particular requirements for the basic safety and essential performance of ultrasonic diagnostic and monitoring equipment".

Transducer surface temperature rise

The tables in this section list the measured surface temperature rise from ambient ($23^{\circ}\text{C} \pm 3^{\circ}\text{C}$) of transducers used on the ultrasound system. The temperatures were measured in accordance with IEC 60601-2-37 with controls and settings positioned to give maximum temperatures.

Table 52. Maximum transducer surface temperature rise, external use ($^{\circ}\text{C}$)

Test	C5-1	C10-3	L12-3	L13-6	L15-4	L19-5	P5-1
Still air	13.8 (≤ 27)	10.6 (≤ 27)	12.3 (≤ 27)	13.0 (≤ 27)	12.0 (≤ 27)	11.4 (≤ 27)	15.2 (≤ 27)
Simulated use	9.4 (≤ 10)	8.2 (< 10)	8.5 (≤ 10)	8.6 (≤ 10)	8.6 (≤ 10)	8.2 (≤ 10)	8.6 (≤ 10)

Table 53. Maximum transducer surface temperature rise, non-external use (°C)

Test	IC10-3
Still air	8.3 (≤27)
Simulated use	4.7 (≤6)

Acoustic output measurement

Since the initial use of diagnostic ultrasound, the possible human biological effects (bioeffects) from ultrasound exposure have been studied by various scientific and medical institutions. In October 1987, AIUM ratified a report from its Bioeffects Committee (Bioeffects Considerations for the Safety of Diagnostic Ultrasound, J Ultrasound Med., Sept. 1988: Vol. 7, No. 9 Supplement). The report, sometimes referred to as the Stowe Report, reviewed available data on possible effects of ultrasound exposure. Another report, "Bioeffects and Safety of Diagnostic Ultrasound," dated January 28, 1993, provides more current information.

The acoustic output for this ultrasound system has been measured and calculated in accordance with IEC 60601-2-37: 2015, Medical electrical equipment -- Part 2-37: Particular requirements for the safety and essential performance of ultrasonic diagnostic and monitoring equipment and IEC 62359: 2017, Ultrasonics - Field characterization - Test methods for the determination of thermal and mechanical indices related to medical diagnostic ultrasonic fields.

In Situ, derated, and water value intensities

All intensity parameters are measured in water. Since water does not absorb acoustic energy, these water measurements represent a worst case value. Biological tissue does absorb acoustic energy. The true value of the intensity at any point depends on the amount, type of tissue, and the frequency of the ultrasound passing through the tissue. The intensity value in the tissue, *In Situ*, has been estimated by using the following formula:

$$I_{\text{In Situ}} = I_{\text{Water}} [e^{-(0.23alf)}]$$

where:

$I_{\text{In Situ}}$ = *In Situ* intensity value

I_{Water} = Water intensity value

$e = 2.7183$

a = attenuation factor (dB/cm MHz)

Attenuation factor (a) for various tissue types are given below:

brain = 0.53

heart = 0.66

kidney = 0.79

liver = 0.43

muscle = 0.55

l = skinline to measurement depth in cm

f = center frequency of the transducer/system/mode combination in MHz

Since the ultrasonic path during the exam is likely to pass through varying lengths and types of tissue, it is difficult to estimate the true in situ intensity. An attenuation factor of 0.3 is used for general reporting purposes; therefore, the In Situ value commonly reported uses the formula:

$$\text{In Situ (derated)} = \text{Water} [e^{-(0.069lf)}]$$

Since this value is not the true In Situ intensity, the term “derated” is used to qualify it.

The maximum derated and the maximum water values do not always occur at the same operating conditions; therefore, the reported maximum water and derated values may not be related by the In Situ (derated) formula. For example: a multi-zone array transducer that has maximum water value intensities in its deepest zone, but also has the smallest derating factor in that zone. The same transducer may have its largest derated intensity in one of its shallowest focal zones.

Tissue models and equipment survey

Tissue models are necessary to estimate attenuation and acoustic exposure levels In Situ from measurements of acoustic output made in water. Currently, available models may be limited in their accuracy because of varying tissue paths during diagnostic ultrasound exposures and uncertainties in the acoustic properties of soft tissues. No single tissue model is adequate for predicting exposures in all situations from measurements made in water, and continued improvement and verification of these models is necessary for making exposure assessments for specific exam types.

A homogeneous tissue model with attenuation coefficient of 0.3 dB/cm MHz throughout the beam path is commonly used when estimating exposure levels. The model is conservative in that it overestimates the In Situ acoustic exposure when the path between the transducer and site of interest is composed entirely of soft tissue. When the path contains significant amounts of fluid, as in many first and second-trimester pregnancies scanned transabdominally, this model may underestimate the In Situ acoustic exposure. The amount of underestimation depends upon each specific situation.

Fixed-path tissue models, in which soft tissue thickness is held constant, sometimes are used to estimate In Situ acoustic exposures when the beam path is longer than 3 cm and consists largely of fluid. When this model is used to estimate maximum exposure to the fetus during transabdominal scans, a value of 1 dB/cm MHz may be used during all trimesters.

Existing tissue models that are based on linear propagation may underestimate acoustic exposures when significant saturation due to non-linear distortion of beams in water is present during the output measurement.

The maximum acoustic output levels of diagnostic ultrasound devices extend over a broad range of values:

- A survey of 1990-equipment models yielded MI values between 0.1 and 1.0 at their highest output settings. Maximum MI values of approximately 2.0 are known to occur for currently available equipment. Maximum MI values are similar for real-time 2D and M Mode imaging.
- Computed estimates of upper limits to temperature elevations during transabdominal scans were obtained in a survey of 1988 and 1990 pulsed Doppler equipment. The vast majority of models yielded upper limits less than 1° and 4°C (1.8° and 7.2°F) for exposures of first-trimester fetal tissue and second-trimester fetal bone, respectively. The largest values obtained were approximately 1.5°C (2.7°F) for first-trimester fetal tissue and 7°C (12.6°F) for second-trimester fetal bone. Estimated maximum temperature elevations given here are for a “fixed path” tissue model and are for devices having ISPTA values greater than 500 mW/cm². The temperature

elevations for fetal bone and tissue were computed based on calculation procedures given in Sections 4.3.2.1-4.3.2.6 in “Bioeffects and Safety of Diagnostic Ultrasound” (AIUM, 1993).

Acoustic output tables

The tables in this section indicate the acoustic output for the system and transducer combinations with a TI or MI equal to or greater than one, and in all cases for the Ophthalmic and Orbital exam types. These tables are organized by transducer model and imaging mode. For a definition of terms used in the tables, see [Terminology in acoustic output tables \[254\]](#).

Table 54. Acoustic output table key

(a)	This index is not required for this operating mode; value is <1.
(b)	This transducer is not intended for transcranial or neonatal cephalic uses.
#	No data are reported for this operating condition since the global maximum index value is not reported for the reason listed. (Reference global maximum index value line.)
—	Not applicable for this transducer/mode.

- [C5-1 acoustic output tables \[202\]](#)
- [IC10-3 acoustic output tables \[210\]](#)
- [L12-3 acoustic output tables \[214\]](#)
- [L15-4 acoustic output tables \[230\]](#)
- [L19-5 acoustic output table \[236\]](#)
- [P5-1 acoustic output tables \[246\]](#)

C5-1 acoustic output tables

Table 55. Transducer model: C5-1 Operating mode: 2D

Index label		MI	TIS		TIB		TIC
			At surface	Below surface	At surface	Below surface	At surface
Maximum index value		1.56	1.25		1.25		(b)
Index component value			1.25	1.25	1.25	1.25	
Acoustic parameters	$p_{r, \alpha}$ at z_{MI} (MPa)	2.34					
	P (mW)		290.3		290.3		#
	$P_{1 \times 1}$ (mW)		98.5		98.5		
	z_s (cm)			—			
	z_b (cm)					—	
	z_{MI} (cm)	3.8					
	$z_{pii, \alpha}$ (cm)	3.8					
	f_{awf} (MHz)	2.23	2.66		2.66		#
Other information	prf (Hz)	2778					
	srr (Hz)	21.7					
	η_{pps}	1					
	$I_{pa, \alpha}$ at $z_{pii, \alpha}$ (W/cm ²)	309.2					
	$I_{spta, \alpha}$ at $z_{pii, \alpha}$ or $z_{sii, \alpha}$ (mW/cm ²)	15.7					
	I_{spta} at z_{pii} or z_{sii} (mW/cm ²)	27.4					
	p_r at z_{pii} (MPa)	3.03					
Operating controls	Exam type	MSK	Gyn		Gyn		
	Optimization	Gen	Pen		Pen		
	Depth (cm)	8.7	8.3		8.3		
	MB/THI	Off/on	Off/on		Off/on		
	AQ zoom	—	Medium/middle		Medium/middle		
	Needle profiling	Off	—		—		
	Variable sector	—	—		—		

Table 56. Transducer model: C5-1 Operating mode: 2D + M Mode

Index label		MI	TIS		TIB		TIC
			At surface	Below surface	At surface	Below surface	At surface
Maximum index value		1.56	1.26		1.92		(b)
Index component value			1.20	1.26	1.00	1.92	
Acoustic parameters	$p_{r, \alpha}$ at z_{MI} (MPa)	2.28					
	P (mW)		269.8		166.1		#
	$P_{1 \times 1}$ (mW)		95.4		98.8		
	z_s (cm)			3.6			
	z_b (cm)					3.6	
	z_{MI} (cm)	3.2					
	$z_{pii, \alpha}$ (cm)	3.2					
	f_{awf} (MHz)	2.12	2.65		2.13		#
Other information	prr (Hz)	2369					
	srr (Hz)	15.4					
	n_{pps}	1					
	$I_{pa, \alpha}$ at $z_{pii, \alpha}$ (W/cm^2)	258.8					
	$I_{spta, \alpha}$ at $z_{pii, \alpha}$ or $z_{sii, \alpha}$ (mW/cm^2)	14.1					
	I_{spta} at z_{pii} or z_{sii} (mW/cm^2)	23.6					
	p_r at z_{pii} (MPa)	2.70					
Operating controls	Exam type	Abdomen	Abdomen		OB		
	Optimization	Gen	Pen		Gen		
	Depth (cm)	7.7	20.7		8.7		
	MB/THI	Off/on	Off/on		Off/on		
	AQ zoom	Off	Medium/middle		Small/middle		
	Needle profiling	—	—		—		
	Variable sector	—	—		—		

Table 57. Transducer model: C5-1 Operating mode: Color/CPD

Index label		MI	TIS		TIB		TIC
			At surface	Below surface	At surface	Below surface	At surface
Maximum index value		1.55	1.67		1.67		(b)
Index component value			1.67	1.67	1.67	1.67	
Acoustic parameters	$p_{r, \alpha}$ at z_{MI} (MPa)	2.30					
	P (mW)		187.8		187.8		#
	$P_{1 \times 1}$ (mW)		125.3		125.3		
	z_s (cm)			—			
	z_b (cm)					—	
	z_{MI} (cm)	4.6					
	$z_{pii, \alpha}$ (cm)	4.6					
	f_{awf} (MHz)	2.21	2.75		2.75		#
Other information	prf (Hz)	1175					
	srr (Hz)	9.1					
	η_{pps}	1					
	$I_{pa, \alpha}$ at $z_{pii, \alpha}$ (W/cm ²)	276.6					
	$I_{spta, \alpha}$ at $z_{pii, \alpha}$ or $z_{sii, \alpha}$ (mW/cm ²)	9.6					
	I_{spta} at z_{pii} or z_{sii} (mW/cm ²)	16.5					
	p_r at z_{pii} (MPa)	3.09					
Operating controls	Exam type	MSK	Gyn		Gyn		
	Mode	Color	Color		Color		
	2D optimization/depth (cm)	Gen/11.2	Pen/8.7		Pen/8.7		
	THI	On	Off		Off		
	Color optimization/PRF (Hz)	Low/219	Low/868		Low/868		
	Color box position/size	Top/default	Default/narrow-short		Default/narrow-short		
	AQ zoom	—	On		On		
Variable sector	—	—		—			

Table 58. Transducer model: C5-1 Operating mode: PW Doppler

Index label		MI	TIS		TIB		TIC
			At surface	Below surface	At surface	Below surface	At surface
Maximum index value		1.35	2.29		4.52		(b)
Index component value			1.09	2.29	1.09	4.52	
Acoustic parameters	$p_{r, \alpha}$ at z_{MI} (MPa)	1.99					
	P (mW)		375.5		375.5		#
	$P_{1 \times 1}$ (mW)		103.1		103.1		
	z_s (cm)			3.6			
	z_b (cm)					3.6	
	z_{MI} (cm)	3.4					
	$z_{pii, \alpha}$ (cm)	3.4					
	f_{awf} (MHz)	2.19	2.23		2.23		#
Other information	prf (Hz)	1008					
	srr (Hz)	—					
	n_{pps}	1					
	$I_{pa, \alpha}$ at $z_{pii, \alpha}$ (W/cm ²)	254.3					
	$I_{spta, \alpha}$ at $z_{pii, \alpha}$ or $z_{sii, \alpha}$ (mW/cm ²)	341.2					
	I_{spta} at z_{pij} or z_{sii} (mW/cm ²)	582.9					
	p_r at z_{pii} (MPa)	2.48					
Operating controls	Exam type	Abdomen	Abdomen		Abdomen		
	Gate size (mm)	1	4		4		
	Gate position (cm)	Zone 3 (3.8)	Zone 9 (14.1)		Zone 9 (14.1)		
	PRF (Hz)	1008	3906		3906		
	TDI	—	—		—		

C10-3 acoustic output tables

Table 59. Transducer model: C10-3 Operating mode: 2D

Index label		MI	TIS		TIB		TIC
			At surface	Below surface	At surface	Below surface	At surface
Maximum index value		1.37	1.41		1.41		(b)
Index component value			1.41	1.41	1.41	1.41	
Acoustic parameters	$p_{r, \alpha}$ at z_{MI} (MPa)	2.74					
	P (mW)		87.1		87.1		
	$P_{1 \times 1}$ (mW)		66.6		66.6		
	z_s (cm)			—			
	z_b (cm)					—	
	z_{MI} (cm)	0.5					
	$z_{pii, \alpha}$ (cm)	0.5					
	f_{awf} (MHz)	4.02	4.45		4.45		
Other information	pr (Hz)	5500					
	srr (Hz)	50.0					
	n_{pps}	1					
	$I_{pa, \alpha}$ at $z_{pii, \alpha}$ (W/cm ²)	279.6					
	$I_{spta, \alpha}$ at $z_{pii, \alpha}$ or $z_{sii, \alpha}$ (mW/cm ²)	15.5					
	I_{spta} at z_{pii} or z_{sii} (mW/cm ²)	22.3					
	p_r at z_{pii} (MPa)	2.79					
Operating controls	Exam type	Abdomen	Abdomen		Abdomen		
	Optimization	Gen	Res		Res		
	Depth (cm)	3.0	9.5		9.5		
	MB/THI	Off/on	Off/on		Off/on		
	AQ zoom	Max/middle	Small/middle		Small/middle		
	SNP	Off	Off		Off		

Table 60. Transducer model: C10-3 Operating mode: 2D + M Mode

Index label		MI	TIS		TIB		TIC
			At surface	Below surface	At surface	Below surface	At surface
Maximum index value		1.47	1.16		1.39		(b)
Index component value			1.16	1.10	1.10	1.39	
Acoustic parameters	$p_{r, \alpha}$ at z_{MI} (MPa)	2.94					
	P (mW)		77.8		68.4		
	$P_{1 \times 1}$ (mW)		60.9		61.3		
	z_s (cm)			1.0			
	z_b (cm)					1.1	
	z_{MI} (cm)	0.4					
	$z_{pii, \alpha}$ (cm)	0.4					
	f_{awf} (MHz)	4.02	4.00		3.74		
Other information	prf (Hz)	2000					
	srr (Hz)	50.0					
	n_{pps}	1					
	$I_{pa, \alpha}$ at $z_{pii, \alpha}$ (W/cm^2)	319.5					
	$I_{spta, \alpha}$ at $z_{pii, \alpha}$ or $z_{sii, \alpha}$ (mW/cm^2)	17.4					
	I_{spta} at z_{pii} or z_{sii} (mW/cm^2)	27.0					
	p_r at z_{pii} (MPa)	2.96					
Operating controls	Exam type	Abdomen	Abdomen		Abdomen		
	Optimization	Gen	Gen		Gen		
	Depth (cm)	3.0	6.5		5.0		
	MB/THI	Off/on	Off/off		Off/off		
	AQ zoom	Small/top	Small/bottom		Small/middle		
	SNP	—	—		—		

Table 61. Transducer model: C10-3 Operating mode: Color

Index label		MI	TIS		TIB		TIC
			At surface	Below surface	At surface	Below surface	At surface
Maximum index value		1.46	1.48		1.48		(b)
Index component value			1.48	1.48	1.48	1.48	
Acoustic parameters	$p_{r, \alpha}$ at z_{MI} (MPa)	2.93					
	P (mW)		101.7		101.7		
	$P_{1 \times 1}$ (mW)		78.9		78.9		
	z_s (cm)			—			
	z_b (cm)					—	
	z_{MI} (cm)	0.4					
	$z_{pii, \alpha}$ (cm)	0.4					
	f_{awf} (MHz)	4.02	3.83		3.83		
Other information	prf (Hz)	1769					
	srr (Hz)	23.6					
	n_{pps}	1					
	$I_{pa, \alpha}$ at $z_{pii, \alpha}$ (W/cm ²)	312.3					
	$I_{spta, \alpha}$ at $z_{pii, \alpha}$ or $z_{sii, \alpha}$ (mW/cm ²)	6.5					
	I_{spta} at z_{pii} or z_{sii} (mW/cm ²)	10.1					
	p_r at z_{pii} (MPa)	2.94					
Operating controls	Exam type	Abdomen	Abdomen		Abdomen		
	Mode	Color	Color		Color		
	2D optimization/depth (cm)	Gen/3.0	Res/9.5		Res/9.5		
	THI	On	Off		Off		
	Color optimization/ PRF (Hz)	Low/753	Medium/1562		Medium/1562		
	Color box position/size	Top/default	Default/narrow-short		Default/narrow-short		
	AQ zoom	On	On		On		

Table 62. Transducer model: C10-3 Operating mode: PW Doppler

Index label		MI	TIS		TIB		TIC
			At surface	Below surface	At surface	Below surface	At surface
Maximum index value		1.01	1.74		3.09		(b)
Index component value			0.92	1.74	1.43	3.09	
Acoustic parameters	$p_{r, \alpha}$ at z_{MI} (MPa)	1.93					
	P (mW)		202.6		129.2		#
	$P_{1 \times 1}$ (mW)		52.4		81.5		
	z_s (cm)			2.8			
	z_b (cm)					2.9	
	z_{MI} (cm)	1.1					
	$z_{pii, \alpha}$ (cm)	1.1					
	f_{awf} (MHz)	3.66	3.68		3.69		#
Other information	prf (Hz)	1563					
	srr (Hz)	—					
	n_{pps}	1					
	$I_{pa, \alpha}$ at $z_{pii, \alpha}$ (W/cm ²)	185.8					
	$I_{spta, \alpha}$ at $z_{pii, \alpha}$ or $z_{sii, \alpha}$ (mW/cm ²)	372.7					
	I_{spta} at z_{pii} or z_{sii} (mW/cm ²)	615.6					
	p_r at z_{pii} (MPa)	1.96					
Operating controls	Exam type	Abdomen	Abdomen		Abdomen		
	Gate size (mm)	1	3		3		
	Gate position (cm)	Zone 2 (1.9)	Zone 11 (14.0)		Zone 6 (6.1)		
	PRF (Hz)	1562	3906		1953		

IC10-3 acoustic output tables

Table 63. Transducer model: IC10-3 Operating mode: 2D

Index label		MI	TIS		TIB		TIC
			At surface	Below surface	At surface	Below surface	At surface
Maximum index value		0.73	0.28		0.28		(b)
Index component value			0.28	0.28	0.28	0.28	
Acoustic parameters	$p_{r, \alpha}$ at z_{MI} (MPa)	1.66					
	P (mW)		14.5		14.5		#
	$P_{1 \times 1}$ (mW)		11.2		11.2		
	z_s (cm)			—			
	z_b (cm)					—	
	z_{MI} (cm)	2.2					
	$z_{pii, \alpha}$ (cm)	2.2					
	f_{awf} (MHz)	5.14	5.28		5.28		#
Other information	prf (Hz)	2400					
	srr (Hz)	50.0					
	n_{pps}	2					
	$I_{pa, \alpha}$ at $z_{pii, \alpha}$ (W/cm ²)	134.7					
	$I_{spta, \alpha}$ at $z_{pii, \alpha}$ or $z_{sii, \alpha}$ (mW/cm ²)	8.8					
	I_{spta} at z_{pii} or z_{sii} (mW/cm ²)	16.4					
	p_r at z_{pii} (MPa)	2.40					
Operating controls	Exam type	Gyn	Gyn		Gyn		
	Optimization	Gen	Gen		Gen		
	Depth (cm)	5.2	4.1		4.1		
	MB/THI	On/off	On/off		On/off		
	AQ zoom	Small/middle	Medium/middle		Medium/middle		
	Needle profiling	—	—		—		
	Variable sector	—	—		—		

Table 64. Transducer model: IC10-3 Operating mode: 2D + M Mode

Index label		MI	TIS		TIB		TIC
			At surface	Below surface	At surface	Below surface	At surface
Maximum index value		0.73	0.23		0.25		(b)
Index component value			0.23	0.22	0.23	0.25	
Acoustic parameters	$P_{r, \alpha}$ at z_{MI} (MPa)	1.66					
	P (mW)		12.3		12.3		#
	$P_{1 \times 1}$ (mW)		9.3		9.3		
	z_s (cm)			1.0			
	z_b (cm)					2.2	
	z_{MI} (cm)	2.2					
	$z_{pii, \alpha}$ (cm)	2.2					
	f_{awf} (MHz)	5.14	5.14		5.14		#
Other information	pr (Hz)	6286					
	srr (Hz)	57.1					
	η_{pps}	1					
	$I_{pa, \alpha}$ at $z_{pii, \alpha}$ (W/cm ²)	134.7					
	$I_{spta, \alpha}$ at $z_{pii, \alpha}$ or $z_{sii, \alpha}$ (mW/cm ²)	3.2					
	I_{spta} at z_{pii} or z_{sii} (mW/cm ²)	6.0					
	P_r at z_{pii} (MPa)	2.40					
Operating controls	Exam type	Gyn	Gyn		Gyn		
	Optimization	Gen	Gen		Gen		
	Depth (cm)	5.2	5.2		5.2		
	MB/THI	Off/off	Off/off		Off/off		
	AQ zoom	Off	Medium/middle		Medium/middle		
	Needle profiling	—	—		—		
	Variable sector	—	—		—		

Table 65. Transducer model: IC10-3 Operating mode: Color/CPD

Index label		MI	TIS		TIB		TIC
			At surface	Below surface	At surface	Below surface	At surface
Maximum index value		0.76	0.30		0.30		(b)
Index component value			0.30	0.30	0.30	0.30	
Acoustic parameters	$p_{r, \alpha}$ at z_{MI} (MPa)	1.61					
	P (mW)		20.1		20.1		#
	$P_{1 \times 1}$ (mW)		15.3		15.3		
	z_s (cm)			—			
	z_b (cm)					—	
	z_{MI} (cm)	1.7					
	$z_{pii, \alpha}$ (cm)	1.7					
	f_{awf} (MHz)	4.46	4.05		4.05		#
Other information	prf (Hz)	1915					
	srr (Hz)	18.4					
	n_{pps}	1					
	$I_{pa, \alpha}$ at $z_{pii, \alpha}$ (W/cm ²)	117.3					
	$I_{spta, \alpha}$ at $z_{pii, \alpha}$ or $z_{sii, \alpha}$ (mW/cm ²)	1.3					
	I_{spta} at z_{pii} or z_{sii} (mW/cm ²)	2.2					
	p_r at z_{pii} (MPa)	2.04					
Operating controls	Exam type	OB	OB		OB		
	Mode	Color	Color		Color		
	2D optimization/depth (cm)	Gen/4.1	Gen/3.0		Gen/3.0		
	THI	On	Off		Off		
	Color optimization/PRF (Hz)	Low/324	Low/648		Low/648		
	Color box position/size	Top/default	Default/default		Default/default		
	AQ zoom	Off	Off		Off		
Variable sector	—	—		—			

Table 66. Transducer model: IC10-3 Operating mode: PW Doppler

Index label		MI	TIS		TIB		TIC
			At surface	Below surface	At surface	Below surface	At surface
Maximum index value		0.72	0.30		0.93		(b)
Index component value			0.30	0.21	0.25	0.93	
Acoustic parameters	$p_{r, \alpha}$ at z_{MI} (MPa)	1.51					
	P (mW)		14.3		12.1		#
	$P_{1 \times 1}$ (mW)		14.3		12.1		
	z_s (cm)			1.1			
	z_b (cm)					1.5	
	z_{MI} (cm)	1.6					
	$z_{pii, \alpha}$ (cm)	1.6					
	f_{awf} (MHz)	4.37	4.37		4.37		#
Other information	prf (Hz)	1008					
	srr (Hz)	—					
	n_{pps}	1					
	$I_{pa, \alpha}$ at $z_{pii, \alpha}$ (W/cm^2)	122.1					
	$I_{spta, \alpha}$ at $z_{pii, \alpha}$ or $z_{sii, \alpha}$ (mW/cm^2)	143.7					
	I_{spta} at z_{pii} or z_{sii} (mW/cm^2)	293.3					
	p_r at z_{pii} (MPa)	1.82					
Operating controls	Exam type	OB	OB		OB		
	Gate size (mm)	1	2		2		
	Gate position (cm)	Zone 2 (2.0)	Zone 4 (3.5)		Zone 2 (2.0)		
	PRF (Hz)	1008	3906		6250		
	TDI	—	—		—		

L12-3 acoustic output tables

Table 67. Transducer model: L12-3 Operating mode: 2D

Index label		MI	TIS		TIB		TIC
			At surface	Below surface	At surface	Below surface	At surface
Maximum index value		1.59	0.83		0.83		(b)
Index component value			0.83	0.83	0.83	0.83	
Acoustic parameters	$p_{r, \alpha}$ at z_{MI} (MPa)	3.77					
	P (mW)		112.6		112.6		#
	$P_{1 \times 1}$ (mW)		31.6		31.6		
	z_s (cm)			—			
	z_b (cm)					—	
	z_{MI} (cm)	1.8					
	$z_{pii, \alpha}$ (cm)	1.8					
	f_{awf} (MHz)	5.66	5.49		5.49		#
Other information	pr (Hz)	7465					
	srr (Hz)	19.4					
	n_{pps}	3					
	$I_{pa, \alpha}$ at $z_{pii, \alpha}$ (W/cm ²)	516.2					
	$I_{spta, \alpha}$ at $z_{pii, \alpha}$ or $z_{sii, \alpha}$ (mW/cm ²)	47.5					
	I_{spta} at z_{pii} or z_{sii} (mW/cm ²)	77.0					
	p_r at z_{pii} (MPa)	5.31					
Operating controls	Exam type	Venous	Venous		Venous		
	Optimization	Gen	Gen		Gen		
	Depth (cm)	3.4	7.6		7.6		
	MB/THI	On/off	On/off		On/off		
	AQ zoom	—	—		—		
	Needle profiling	Off	Off		Off		
	Variable sector	—	—		—		

Table 68. Transducer model: L12-3 Operating mode: 2D + M Mode

Index label		MI	TIS		TIB		TIC
			At surface	Below surface	At surface	Below surface	At surface
Maximum index value		1.59	0.87		0.99		(b)
Index component value			0.87	0.83	0.84	0.99	
Acoustic parameters	$P_{r, \alpha}$ at z_{MI} (MPa)	3.77					
	P (mW)		104.5		95.1		#
	$P_{1 \times 1}$ (mW)		33.2		31.1		
	z_s (cm)			1.05			
	z_b (cm)					1.2	
	z_{MI} (cm)	1.8					
	$z_{pii, \alpha}$ (cm)	1.8					
	f_{awf} (MHz)	5.66	5.49		5.51		#
Other information	prf (Hz)	10000					
	srr (Hz)	50.0					
	η_{pps}	1					
	$I_{pa, \alpha}$ at $z_{pii, \alpha}$ (W/cm ²)	516.2					
	$I_{spta, \alpha}$ at $z_{pii, \alpha}$ or $z_{sii, \alpha}$ (mW/cm ²)	63.6					
	I_{spta} at z_{pii} or z_{sii} (mW/cm ²)	103.1					
	p_r at z_{pii} (MPa)	5.31					
Operating controls	Exam type	Venous	Venous		Superficial		
	Optimization	Gen	Gen		Gen		
	Depth (cm)	4.7	7.6		5.5		
	MB/THI	Off/off	Off/off		Off/off		
	AQ zoom	—	—		—		
	Needle profiling	—	—		—		
	Variable sector	—	—		—		

Table 69. Transducer model: L12-3 Operating mode: Color/CPD

Index label		MI	TIS		TIB		TIC
			At surface	Below surface	At surface	Below surface	At surface
Maximum index value		1.59	1.51		1.51		(b)
Index component value			1.51	1.51	1.51	1.51	
Acoustic parameters	$p_{r, \alpha}$ at z_{MI} (MPa)	3.77					
	P (mW)		92.5		92.5		#
	$P_{1 \times 1}$ (mW)		54.3		54.3		
	z_s (cm)			—			
	z_b (cm)					—	
	z_{MI} (cm)	1.8					
	$z_{pii, \alpha}$ (cm)	1.8					
	f_{awf} (MHz)	5.66	5.80		5.80		#
Other information	prr (Hz)	3784					
	srr (Hz)	19.6					
	η_{pps}	1					
	$I_{pa, \alpha}$ at $z_{pii, \alpha}$ (W/cm ²)	516.2					
	$I_{spta, \alpha}$ at $z_{pii, \alpha}$ or $z_{sii, \alpha}$ (mW/cm ²)	23.9					
	I_{spta} at z_{pii} or z_{sii} (mW/cm ²)	38.8					
	p_r at z_{pii} (MPa)	5.31					
Operating controls	Exam type	Arterial	Breast		Breast		
	Mode	Color	Color		Color		
	2D optimization/ depth (cm)	Gen/4.7	Res/2.9		Res/2.9		
	THI	Off	Off		Off		
	Color optimization/ PRF (Hz)	High/12500	Low/1096		Low/1096		
	Color box position/size	Top/default	Bottom/default		Bottom/default		
	AQ zoom	—	—		—		
	Variable sector	—	—		—		

Table 70. Transducer model: L12-3 Operating mode: PW Doppler

Index label		MI	TIS		TIB		TIC
			At surface	Below surface	At surface	Below surface	At surface
Maximum index value		1.06	1.40		2.79		(b)
Index component value			1.40	1.24	1.40	2.79	
Acoustic parameters	$p_{r, \alpha}$ at z_{MI} (MPa)	2.33					
	P (mW)		77.8		77.8		#
	$P_{1 \times 1}$ (mW)		60.8		60.8		
	z_s (cm)			1.1			
	z_b (cm)					1.35	
	z_{MI} (cm)	1.35					
	$z_{pii, \alpha}$ (cm)	1.35					
	f_{awf} (MHz)	4.82	4.82		4.82		#
Other information	prf (Hz)	1563					
	srr (Hz)	—					
	n_{pps}	1					
	$I_{pa, \alpha}$ at $z_{pii, \alpha}$ (W/cm^2)	201.7					
	$I_{spta, \alpha}$ at $z_{pii, \alpha}$ or $z_{sii, \alpha}$ (mW/cm^2)	391.2					
	I_{spta} at z_{pii} or z_{sii} (mW/cm^2)	622.0					
	p_r at z_{pii} (MPa)	2.74					
Operating controls	Exam type	Venous	Venous		Venous		
	Gate size (mm)	1	1		1		
	Gate position (cm)	Zone 11 (7.0)	Zone 11 (7.0)		Zone 11 (7.0)		
	PRF (Hz)	1562	1562		1562		
	TDI	—	—		—		

Table 71. Transducer model: L12-3 Operating mode: 2D + PW Doppler

Index label		MI	TIS		TIB		TIC
			At surface	Below surface	At surface	Below surface	At surface
Maximum index value		1.66	1.53		2.97		(b)
Index component value			1.53	1.40	1.53	2.97	
Acoustic parameters	$p_{r, \alpha}$ at z_{MI} (MPa)	4.07					
	P (mW)		90.0		90.0		#
	$P_{1 \times 1}$ (mW)		65.0		65.0		
	z_s (cm)			1.05			
	z_b (cm)					1.05	
	z_{MI} (cm)	1.4					
	$z_{pii, \alpha}$ (cm)	1.4					
	f_{awf} (MHz)	6.05	4.82		4.82		#
Other information	prr (Hz)	7812					
	srr (Hz)	40.7					
	n_{pps}	1					
	$I_{pa, \alpha}$ at $z_{pii, \alpha}$ (W/cm ²)	675.4					
	$I_{spta, \alpha}$ at $z_{pii, \alpha}$ or $z_{sii, \alpha}$ (mW/cm ²)	27.8					
	I_{spta} at z_{pii} or z_{sii} (mW/cm ²)	47.5					
	p_r at z_{pii} (MPa)	5.49					
Operating controls	Exam type	Arterial	Venous		Venous		
	Optimization/ depth (cm)	Gen/3.4	Res/9.0		Res/9.0		
	THI	On	On		On		
	Gate size (mm)	1	1		1		
	Gate position (cm)	Zone 1 (0.6)	Zone 11 (7.0)		Zone 11 (7.0)		
	PRF (Hz)	2604	3906		3906		

Table 72. Transducer model: L12-3 Operating mode: 2D + PW Doppler + Color

Index label		MI	TIS		TIB		TIC
			At surface	Below surface	At surface	Below surface	At surface
Maximum index value		1.61	1.54		2.75		(b)
Index component value			1.54	1.42	1.54	2.75	
Acoustic parameters	$p_{r, \alpha}$ at z_{MI} (MPa)	3.98					
	P (mW)		108.4		108.4		#
	$P_{1 \times 1}$ (mW)		67.0		67.0		
	z_s (cm)			1.05			
	z_b (cm)					1.05	
	z_{MI} (cm)	1.4					
	$z_{pii, \alpha}$ (cm)	1.4					
	f_{awf} (MHz)	6.06	4.80		4.80		#
Other information	prr (Hz)	2116					
	srr (Hz)	16.3					
	n_{pps}	1					
	$I_{pa, \alpha}$ at $z_{pii, \alpha}$ (W/cm ²)	652.6					
	$I_{spta, \alpha}$ at $z_{pii, \alpha}$ or $z_{sii, \alpha}$ (mW/cm ²)	7.2					
	I_{spta} at z_{pii} or z_{sii} (mW/cm ²)	12.4					
	p_r at z_{pii} (MPa)	5.34					
Operating controls	Exam type	Arterial	Venous		Venous		
	2D optimization/ depth (cm)	Gen/4.0	Res/9.0		Res/9.0		
	THI	On	On		On		
	Color optimization/ PRF (Hz)	5208	2604		2604		
	Gate size (mm)	1	1		1		
	Gate position (cm)	Zone 1 (0.6)	Zone 11 (7.0)		Zone 11 (7.0)		

Table 73. Transducer model: L12-3 Ophthalmic Operating mode: 2D

Index label		MI	TIS		TIB		TIC
			At surface	Below surface	At surface	Below surface	At surface
Maximum index value		0.17	0.04		0.04		(b)
Index component value			0.04	0.04	0.04	0.04	
Acoustic parameters	$p_{r, \alpha}$ at z_{MI} (MPa)	0.48					
	P (mW)		3.1		3.1		#
	$P_{1 \times 1}$ (mW)		0.9		0.9		
	z_s (cm)			—			
	z_b (cm)					—	
	z_{MI} (cm)	1.7					
	$z_{pii, \alpha}$ (cm)	1.7					
	f_{awf} (MHz)	8.53	8.53		8.53		#
Other information	prr (Hz)	6778					
	srr (Hz)	11.8					
	n_{pps}	3					
	$I_{pa, \alpha}$ at $z_{pii, \alpha}$ (W/cm ²)	7.9					
	$I_{spta, \alpha}$ at $z_{pii, \alpha}$ or $z_{sii, \alpha}$ (mW/cm ²)	3.0					
	I_{spta} at z_{pii} or z_{sii} (mW/cm ²)	8.3					
	p_r at z_{pii} (MPa)	1.28					
Operating controls	Exam type	Ophthalmic	Ophthalmic		Ophthalmic		
	Optimization	Res	Res		Res		
	Depth (cm)	9.0	9.0		9.0		
	MB/THI	On/off	On/off		On/off		
	AQ zoom	—	—		—		
	Needle profiling	—	—		—		
	Variable sector	—	—		—		

Table 74. Transducer model: L12-3 Ophthalmic Operating mode: 2D + M Mode

Index label		MI	TIS		TIB		TIC
			At surface	Below surface	At surface	Below surface	At surface
Maximum index value		0.16	0.03		0.03		(b)
Index component value			0.03	0.02	0.03	0.02	
Acoustic parameters	$p_{r, \alpha}$ at z_{MI} (MPa)	0.47					
	P (mW)		1.90		1.90		#
	$P_{1 \times 1}$ (mW)		0.60		0.60		
	z_s (cm)			1.2			
	z_b (cm)					1.45	
	z_{MI} (cm)	3.5					
	$z_{pii, \alpha}$ (cm)	3.5					
	f_{awf} (MHz)	8.87	8.78		8.78		#
Other information	prf (Hz)	6800					
	srr (Hz)	33.3					
	n_{pps}	1					
	$I_{pa, \alpha}$ at $z_{pii, \alpha}$ (W/cm ²)	10.8					
	$I_{spta, \alpha}$ at $z_{pii, \alpha}$ or $z_{sii, \alpha}$ (mW/cm ²)	1.6					
	I_{spta} at z_{pii} or z_{sii} (mW/cm ²)	4.3					
	p_r at z_{pii} (MPa)	1.37					
Operating controls	Exam type	Ophthalmic	Ophthalmic		Ophthalmic		
	Optimization	Res	Res		Res		
	Depth (cm)	7.6	9.0		9.0		
	MB/THI	Off/off	Off/off		Off/off		
	AQ zoom	—	—		—		
	Needle profiling	—	—		—		
	Variable sector	—	—		—		

Table 75. Transducer model: L12-3 Ophthalmic Operating mode: Color/CPD

Index label		MI	TIS		TIB		TIC
			At surface	Below surface	At surface	Below surface	At surface
Maximum index value		0.18	0.05		0.05		(b)
Index component value			0.05	0.05	0.05	0.05	
Acoustic parameters	$p_{r, \alpha}$ at z_{MI} (MPa)	0.53					
	P (mW)		4.2		4.2		#
	$P_{1 \times 1}$ (mW)		2.0		2.0		
	z_s (cm)			—			
	z_b (cm)					—	
	z_{MI} (cm)	0.55					
	$z_{pii, \alpha}$ (cm)	0.55					
	f_{awf} (MHz)	8.63	4.84		4.84		#
Other information	prf (Hz)	3274					
	srr (Hz)	17.0					
	η_{pps}	1					
	$I_{pa, \alpha}$ at $z_{pii, \alpha}$ (W/cm ²)	9.5					
	$I_{spta, \alpha}$ at $z_{pii, \alpha}$ or $z_{sii, \alpha}$ (mW/cm ²)	0.1					
	I_{spta} at z_{pii} or z_{sii} (mW/cm ²)	0.4					
	p_r at z_{pii} (MPa)	0.60					
Operating controls	Exam type	Ophthalmic	Ophthalmic		Ophthalmic		
	Mode	Color	Color		Color		
	2D optimization/ depth (cm)	Res/1.8	Res/9.0		Res/9.0		
	THI	Off	Off		Off		
	Color optimization/ PRF (Hz)	Low/287	Medium/2358		Medium/2358		
	Color box position/size	Default/default	Bottom/default		Bottom/default		
	AQ zoom	—	—		—		
Variable sector	—	—		—			

Table 76. Transducer model: L12-3 Ophthalmic Operating mode: PW Doppler

Index label		MI	TIS		TIB		TIC
			At surface	Below surface	At surface	Below surface	At surface
Maximum index value		0.15	0.10		0.21		(b)
Index component value			0.10	0.09	0.10	0.21	
Acoustic parameters	$p_{r, \alpha}$ at z_{MI} (MPa)	0.32					
	P (mW)		5.4		5.4		#
	P_{1x1} (mW)		4.2		4.2		
	z_s (cm)			1.05			
	z_b (cm)					1.05	
	z_{MI} (cm)	0.9					
	$z_{pii, \alpha}$ (cm)	0.9					
	f_{awf} (MHz)	4.81	4.80		4.80		#
Other information	prf (Hz)	1563					
	srr (Hz)	—					
	n_{pps}	1					
	$I_{pa, \alpha}$ at $z_{pii, \alpha}$ (W/cm ²)	3.6					
	$I_{spta, \alpha}$ at $z_{pii, \alpha}$ or $z_{sii, \alpha}$ (mW/cm ²)	6.6					
	I_{spta} at z_{pij} or z_{sii} (mW/cm ²)	9.0					
	p_r at z_{pii} (MPa)	0.37					
Operating controls	Exam type	Ophthalmic	Ophthalmic		Ophthalmic		
	Gate size (mm)	1	3		3		
	Gate position (cm)	Zone 3 (1.3)	Zone 11 (7.0)		Zone 11 (7.0)		
	PRF (Hz)	1562	7812		7812		
	TDI	—	—		—		

L13-6 acoustic output tables

Table 77. Transducer model: L13-6 Operating mode: 2D

Index label		MI	TIS		TIB		TIC
			At surface	Below surface	At surface	Below surface	At surface
Maximum index value		1.52	0.27		0.27		(b)
Index component value			0.27	0.27	0.27	0.27	
Acoustic parameters	$p_{r, \alpha}$ at z_{MI} (MPa)	4.19					
	P (mW)		19.2		19.2		#
	$P_{1 \times 1}$ (mW)		8.0		8.0		
	z_s (cm)			—			
	z_b (cm)					—	
	z_{MI} (cm)	0.85					
	$z_{pii, \alpha}$ (cm)	0.85					
	f_{awf} (MHz)	7.54	7.54		7.54		#
Other information	pr (Hz)	6400					
	srr (Hz)	50.0					
	η_{pps}	1					
	$I_{pa, \alpha}$ at $z_{pii, \alpha}$ (W/cm ²)	606.7					
	$I_{spta, \alpha}$ at $z_{pii, \alpha}$ or $z_{sii, \alpha}$ (mW/cm ²)	22.3					
	I_{spta} at z_{pii} or z_{sii} (mW/cm ²)	34.9					
	p_r at z_{pii} (MPa)	5.13					
Operating controls	Exam type	Superficial	Venous		Venous		
	Optimization	Gen	Res		Res		
	Depth (cm)	2.2	6.0		6.0		
	MB/THI	Off/off	On/off		On/off		
	AQ zoom	—	—		—		
	Needle profiling	Off	On		On		
	Variable sector	—	—		—		

Table 78. Transducer model: L13-6 Operating mode: 2D + M Mode

Index label		MI	TIS		TIB		TIC
			At surface	Below surface	At surface	Below surface	At surface
Maximum index value		1.33	0.26		0.30		(b)
Index component value			0.26	0.24	0.22	0.30	
Acoustic parameters	$p_{r, \alpha}$ at z_{MI} (MPa)	3.70					
	P (mW)		15.0		12.9		#
	$P_{1 \times 1}$ (mW)		6.9		5.7		
	z_s (cm)			0.75			
	z_b (cm)					0.85	
	z_{MI} (cm)	0.9					
	$z_{pii, \alpha}$ (cm)	0.9					
	f_{awf} (MHz)	7.71	7.64		7.88		#
Other information	prf (Hz)	5520					
	srf (Hz)	40.0					
	η_{pps}	1					
	$I_{pa, \alpha}$ at $z_{pii, \alpha}$ (W/cm ²)	524.1					
	$I_{spta, \alpha}$ at $z_{pii, \alpha}$ or $z_{sii, \alpha}$ (mW/cm ²)	16.2					
	I_{spta} at z_{pii} or z_{sii} (mW/cm ²)	26.0					
	p_r at z_{pii} (MPa)	4.72					
Operating controls	Exam type	Venous	Superficial		MSK		
	Optimization	Gen	Gen		Gen		
	Depth (cm)	1.8	4.8		1.4		
	MB/THI	Off/off	Off/off		Off/off		
	AQ zoom	—	—		—		
	Needle profiling	—	—		—		
	Variable sector	—	—		—		

Table 79. Transducer model: L13-6 Operating mode: 2D + PW Doppler

Index label		MI	TIS		TIB		TIC
			At surface	Below surface	At surface	Below surface	At surface
Maximum index value		1.52	0.52		1.09		(b)
Index component value			0.52	0.37	0.40	1.09	
Acoustic parameters	$p_{r, \alpha}$ at z_{MI} (MPa)	4.17					
	P (mW)		18.4		14.2		#
	$P_{1 \times 1}$ (mW)		18.2		13.9		
	z_s (cm)			0.85			
	z_b (cm)					1.55	
	z_{MI} (cm)	0.85					
	$z_{pii, \alpha}$ (cm)	0.85					
	f_{awf} (MHz)	7.53	6.00		6.00		#
Other information	prf (Hz)	1953					
	srr (Hz)	23.0					
	n_{pps}	1					
	$I_{pa, \alpha}$ at $z_{pii, \alpha}$ (W/cm ²)	586.3					
	$I_{spta, \alpha}$ at $z_{pii, \alpha}$ or $z_{sii, \alpha}$ (mW/cm ²)	6.8					
	I_{spta} at z_{pii} or z_{sii} (mW/cm ²)	10.7					
	p_r at z_{pii} (MPa)	5.15					
Operating controls	Exam type	Venous	Venous		Venous		
	Optimization/depth (cm)	Gen/2.5	Res/4.8		Res/2.9		
	THI	Off	Off		Off		
	Gate size (mm)	1	3		3		
	Gate position (cm)	Zone 1 (0.4)	Zone 10 (4.3)		Zone 7 (2.6)		
	PRF (Hz)	1953	3125		7812		

Table 80. Transducer model: L13-6 Operating mode: Color

Index label		MI	TIS		TIB		TIC
			At surface	Below surface	At surface	Below surface	At surface
Maximum index value		1.53	0.46		0.46		(b)
Index component value			0.46	0.46	0.46	0.46	
Acoustic parameters	$p_{r, \alpha}$ at z_{MI} (MPa)	4.16					
	P (mW)		19.4		19.4		#
	$P_{1 \times 1}$ (mW)		15.7		15.7		
	z_s (cm)			—			
	z_b (cm)					—	
	z_{MI} (cm)	1.0					
	$z_{pii, \alpha}$ (cm)	1.0					
	f_{awf} (MHz)	7.44	6.10		6.10		#
Other information	prf (Hz)	1767					
	srr (Hz)	20.8					
	n_{pps}	1					
	$I_{pa, \alpha}$ at $z_{pii, \alpha}$ (W/cm ²)	582.6					
	$I_{spta, \alpha}$ at $z_{pii, \alpha}$ or $z_{sii, \alpha}$ (mW/cm ²)	7.5					
	I_{spta} at z_{pii} or z_{sii} (mW/cm ²)	11.8					
	p_r at z_{pii} (MPa)	5.30					
Operating controls	Exam type	Venous	Superficial		Superficial		
	Mode	Color	Color		Color		
	2D optimization/ depth (cm)	Gen	Res		Res		
	THI	Off	Off		Off		
	Color optimization/PRF (Hz)	Low/305	High/9615		High/9615		
	Color box position/size	Default/narrow	Bottom/default		Bottom/default		
	AQ zoom	—	—		—		
	Variable sector	—	—		—		

Table 81. Transducer model: L13-6 Operating mode: PW Doppler

Index label		MI	TIS		TIB		TIC
			At surface	Below surface	At surface	Below surface	At surface
Maximum index value		0.90	0.53		1.11		(a)
Index component value			0.53	0.39	0.41	1.11	
Acoustic parameters	$p_{r, \alpha}$ at z_{MI} (MPa)	2.20					
	P (mW)		18.5		14.3		#
	$P_{1 \times 1}$ (mW)		18.5		14.3		
	z_s (cm)			0.75			
	z_b (cm)					1.6	
	z_{MI} (cm)	0.65					
	$z_{pii, \alpha}$ (cm)	0.65					
	f_{awf} (MHz)	6.01	6.00		6.00		#
Other information	prf (Hz)	1563					
	srr (Hz)	—					
	n_{pps}	1					
	$I_{pa, \alpha}$ at $z_{pii, \alpha}$ (W/cm^2)	197.8					
	$I_{spta, \alpha}$ at $z_{pii, \alpha}$ or $z_{sii, \alpha}$ (mW/cm^2)	394.9					
	I_{spta} at z_{pii} or z_{sii} (mW/cm^2)	527.5					
	p_r at z_{pii} (MPa)	2.47					
Operating controls	Exam type	Venous	Venous		Venous		
	Gate size (mm)	1	3		3		
	Gate position (cm)	Zone 3 (1.0)	Zone 10 (4.3)		Zone 7 (2.6)		
	PRF (Hz)	1562	3125		3125		
	TDI	—	—		—		

Table 82. Transducer model: L13-6 Operating mode: 2D + PW Doppler + Color

Index label		MI	TIS		TIB		TIC
			At surface	Below surface	At surface	Below surface	At surface
Maximum index value		1.44	0.52		1.08		(b)
Index component value			0.52	0.39	0.40	1.08	
Acoustic parameters	$p_{r, \alpha}$ at z_{MI} (MPa)	3.96					
	P (mW)		19.0		14.2		#
	$P_{1 \times 1}$ (mW)		18.1		14.0		
	z_s (cm)			0.75			
	z_b (cm)					1.55	
	z_{MI} (cm)	1.0					
	$z_{pii, \alpha}$ (cm)	1.0					
	f_{awf} (MHz)	7.52	6.00		6.00		#
Other information	prf (Hz)	855					
	srr (Hz)	9.9					
	n_{pps}	1					
	$I_{pa, \alpha}$ at $z_{pii, \alpha}$ (W/cm ²)	536.4					
	$I_{spta, \alpha}$ at $z_{pii, \alpha}$ or $z_{sii, \alpha}$ (mW/cm ²)	3.3					
	I_{spta} at z_{pii} or z_{sii} (mW/cm ²)	5.3					
	p_r at z_{pii} (MPa)	5.08					
Operating controls	Exam type	Venous	Venous		Venous		
	2D optimization/depth (cm)	Gen/2.9	Res/4.8		Res/4.8		
	THI	Off	Off		Off		
	Color optimization/PRF (Hz)	—/1953	—/1953		—/1953		
	Gate size (mm)	1	3		3		
	Gate position (cm)	Zone 1 (0.4)	Zone 10 (4.3)		Zone 7 (2.6)		
	PW PRF (Hz)	3906	6250		10417		

L15-4 acoustic output tables

Table 83. Transducer model: L15-4 Operating mode: 2D

Index label		MI	TIS		TIB		TIC
			At surface	Below surface	At surface	Below surface	At surface
Maximum index value		1.44	0.60		0.60		(b)
Index component value			0.60	0.60	0.60	0.60	
Acoustic parameters	$p_{r, \alpha}$ at z_{MI} (MPa)	3.40					
	P (mW)		72.8		72.8		#
	$P_{1 \times 1}$ (mW)		15.0		15.0		
	z_s (cm)			—			
	z_b (cm)					—	
	z_{MI} (cm)	1.0					
	$z_{pii, \alpha}$ (cm)	1.0					
	f_{awf} (MHz)	5.58	8.60		8.60		#
Other information	pr (Hz)	4611					
	srr (Hz)	10.5					
	n_{pps}	3					
	$I_{pa, \alpha}$ at $z_{pii, \alpha}$ (W/cm ²)	247.0					
	$I_{spta, \alpha}$ at $z_{pii, \alpha}$ or $z_{sii, \alpha}$ (mW/cm ²)	22.1					
	I_{spta} at z_{pii} or z_{sii} (mW/cm ²)	32.7					
	p_r at z_{pii} (MPa)	3.90					
Operating controls	Exam type	Venous	Superficial		Superficial		
	Optimization	Gen	Gen		Gen		
	Depth (cm)	6.0	6.0		6.0		
	MB/THI	On/on	Off/off		Off/off		
	AQ zoom	—	—		—		
	Needle profiling	Off	Off		Off		
	Variable sector	—	—		—		

Table 84. Transducer model: L15-4 Operating mode: 2D + M Mode

Index label		MI	TIS		TIB		TIC
			At surface	Below surface	At surface	Below surface	At surface
Maximum index value		1.44	0.70		0.75		(b)
Index component value			0.70	0.64	0.69	0.75	
Acoustic parameters	$p_{r, \alpha}$ at z_{MI} (MPa)	3.40					
	P (mW)		67.5		73.8		#
	$P_{1 \times 1}$ (mW)		17.6		19.3		
	z_s (cm)			1.0			
	z_b (cm)					0.95	
	z_{MI} (cm)	1.0					
	$z_{pii, \alpha}$ (cm)	1.0					
	f_{awf} (MHz)	5.58	8.59		7.74		#
Other information	prf (Hz)	3931					
	srr (Hz)	13.8					
	n_{pps}	1					
	$I_{pa, \alpha}$ at $z_{pii, \alpha}$ (W/cm ²)	247.0					
	$I_{spta, \alpha}$ at $z_{pii, \alpha}$ or $z_{sii, \alpha}$ (mW/cm ²)	18.8					
	I_{spta} at z_{pii} or z_{sii} (mW/cm ²)	27.8					
	p_r at z_{pii} (MPa)	3.90					
Operating controls	Exam type	MUS	Superficial		MUS		
	Optimization	Gen	Gen		Gen		
	Depth (cm)	6.0	6.0		6.0		
	MB/THI	Off/on	Off/off		Off/off		
	AQ zoom	—	—		—		
	Needle profiling	—	—		—		
	Variable sector	—	—		—		

Table 85. Transducer model: L15-4 Operating mode: Color/CPD

Index label		MI	TIS		TIB		TIC
			At surface	Below surface	At surface	Below surface	At surface
Maximum index value		1.44	1.04		1.04		(b)
Index component value			1.04	1.04	1.04	1.04	
Acoustic parameters	$p_{r, \alpha}$ at z_{MI} (MPa)	3.40					
	P (mW)		55.8		55.8		#
	$P_{1 \times 1}$ (mW)		36.4		36.4		
	z_s (cm)			—			
	z_b (cm)					—	
	z_{MI} (cm)	1.0					
	$z_{pii, \alpha}$ (cm)	1.0					
	f_{awf} (MHz)	5.58	5.87		5.87		#
Other information	prf (Hz)	2387					
	srr (Hz)	13.9					
	n_{pps}	1					
	$I_{pa, \alpha}$ at $z_{pii, \alpha}$ (W/cm ²)	247.0					
	$I_{spta, \alpha}$ at $z_{pii, \alpha}$ or $z_{sii, \alpha}$ (mW/cm ²)	11.3					
	I_{spta} at z_{pii} or z_{sii} (mW/cm ²)	16.7					
	p_r at z_{pii} (MPa)	3.90					
Operating controls	Exam type	Venous	Breast		Breast		
	Mode	CVD	CVD		CVD		
	2D optimization/depth (cm)	Gen/6.0	Res/6.0		Res/6.0		
	THI	On	Off		Off		
	Color optimization/PRF (Hz)	High/4808	Low/1096		Low/1096		
	Color box position/size	Default/default	Default/narrow-short		Default/narrow-short		
	AQ zoom	—	—		—		
	Variable sector	—	—		—		

Table 86. Transducer model: L15-4 Operating mode: PW Doppler

Index label		MI	TIS		TIB		TIC
			At surface	Below surface	At surface	Below surface	At surface
Maximum index value		0.86	0.92		2.01		(b)
Index component value			0.92	0.74	0.92	2.01	
Acoustic parameters	$p_{r, \alpha}$ at z_{MI} (MPa)	1.98					
	P (mW)		43.7		43.7		#
	P_{1x1} (mW)		36.4		36.4		
	z_s (cm)			1.1			
	z_b (cm)					1.15	
	z_{MI} (cm)	0.9					
	$z_{pii, \alpha}$ (cm)	0.9					
	f_{awf} (MHz)	5.33	5.31		5.31		#
Other information	prf (Hz)	1563					
	srr (Hz)	—					
	n_{pps}	1					
	$I_{pa, \alpha}$ at $z_{pii, \alpha}$ (W/cm^2)	181.8					
	$I_{spta, \alpha}$ at $z_{pii, \alpha}$ or $z_{sii, \alpha}$ (mW/cm^2)	342.0					
	I_{spta} at z_{pii} or z_{sii} (mW/cm^2)	468.7					
	p_r at z_{pii} (MPa)	2.27					
Operating controls	Exam type	Venous	Venous		Venous		
	Gate size (mm)	1	1		1		
	Gate position (cm)	Zone 3 (1.1)	Zone 11 (4.7)		Zone 11 (4.7)		
	PRF (Hz)	1562	2604		2604		
	TDI	—	—		—		

Table 87. Transducer model: L15-4 Operating mode: 2D + PW Doppler

Index label		MI	TIS		TIB		TIC
			At surface	Below surface	At surface	Below surface	At surface
Maximum index value		1.44	0.95		1.95		(b)
Index component value			0.95	0.79	0.95	1.95	
Acoustic parameters	$p_{r, \alpha}$ at z_{MI} (MPa)	4.20					
	P (mW)		56.2		56.2		#
	$P_{1 \times 1}$ (mW)		35.7		35.7		
	z_s (cm)			1.1			
	z_b (cm)					1.15	
	z_{MI} (cm)	0.4					
	$z_{pii, \alpha}$ (cm)	0.4					
	f_{awf} (MHz)	8.48	5.31		5.31		#
Other information	prr (Hz)	4688					
	srr (Hz)	21.4					
	n_{pps}	1					
	$I_{pa, \alpha}$ at $z_{pii, \alpha}$ (W/cm ²)	640.1					
	$I_{spta, \alpha}$ at $z_{pii, \alpha}$ or $z_{sii, \alpha}$ (mW/cm ²)	5.2					
	I_{spta} at z_{pii} or z_{sii} (mW/cm ²)	9.9					
	p_r at z_{pii} (MPa)	4.75					
Operating controls	Exam type	Venous	Venous		Venous		
	Optimization/depth (cm)	Res/1.7	Gen/6.0		Gen/6.0		
	THI	On	On		On		
	Gate size (mm)	1	1		1		
	Gate position (cm)	Zone 0 (0.4)	Zone 11 (4.7)		Zone 11 (4.7)		
	PRF (Hz)	1562	1953		1953		

Table 88. Transducer model: L15-4 Operating mode: 2D + PW Doppler + Color

Index label		MI	TIS		TIB		TIC
			At surface	Below surface	At surface	Below surface	At surface
Maximum index value		1.37	1.05		1.91		(b)
Index component value			1.05	0.91	1.05	1.91	
Acoustic parameters	$p_{r, \alpha}$ at z_{MI} (MPa)	4.05					
	P (mW)		65.1		68.2		#
	P_{1x1} (mW)		41.3		41.2		
	z_s (cm)			1.0			
	z_b (cm)					1.15	
	z_{MI} (cm)	1.2					
	$z_{pii, \alpha}$ (cm)	1.2					
	f_{awf} (MHz)	8.76	5.31		5.30		#
Other information	prf (Hz)	1724					
	srr (Hz)	11.7					
	n_{pps}	1					
	$I_{pa, \alpha}$ at $z_{pii, \alpha}$ (W/cm ²)	443.2					
	$I_{spta, \alpha}$ at $z_{pii, \alpha}$ or $z_{sii, \alpha}$ (mW/cm ²)	2.0					
	I_{spta} at z_{pii} or z_{sii} (mW/cm ²)	3.6					
	p_r at z_{pii} (MPa)	5.52					
Operating controls	Exam type	Venous	Venous		Venous		
	2D optimization/depth (cm)	Gen/2.5	Res/5.3		Gen/6.0		
	THI	On	On		On		
	Color optimization/PRF (Hz)	NA/1953	NA/1953		NA/1953		
	Gate size (mm)	1	1		1		
	Gate position (cm)	Zone 0 (0.4)	Zone 10 (4.3)		Zone 11 (4.7)		

L19-5 acoustic output table

Table 89. Transducer model: L19-5 Operating mode: 2D

Index label		MI	TIS		TIB		TIC
			At surface	Below surface	At surface	Below surface	At surface
Maximum index value		1.52	1.01		1.01		(b)
Index component value			1.01	1.01	1.01	1.01	
Acoustic parameters	$p_{r, \alpha}$ at z_{MI} (MPa)	3.87					
	P (mW)		41.3		41.3		#
	$P_{1 \times 1}$ (mW)		23.1		23.1		
	z_s (cm)			—			
	z_b (cm)					—	
	z_{MI} (cm)	0.7					
	$z_{pii, \alpha}$ (cm)	0.7					
	f_{awf} (MHz)	6.49	9.20		9.20		#
Other information	prf (Hz)	2538					
	srr (Hz)	12.8					
	η_{pps}	3					
	$I_{pa, \alpha}$ at $z_{pii, \alpha}$ (W/cm ²)	411.9					
	$I_{spta, \alpha}$ at $z_{pii, \alpha}$ or $z_{sii, \alpha}$ (mW/cm ²)	47.4					
	I_{spta} at z_{pii} or z_{sii} (mW/cm ²)	63.9					
	p_r at z_{pii} (MPa)	4.49					
Operating controls	Exam type	Superficial	MSK		MSK		
	Optimization	Gen	Gen		Gen		
	Depth (cm)	4.5	5.2		5.2		
	MB/THI	On/on	On/off		On/off		
	AQ zoom	—	—		—		
	Needle profiling	On	Off		Off		
	Variable sector	—	—		—		

Table 90. Transducer model: L19-5 Operating mode: 2D + M Mode

Index label		MI	TIS		TIB		TIC
			At surface	Below surface	At surface	Below surface	At surface
Maximum index value		1.52	1.01		1.05		(b)
Index component value			1.01	0.95	1.01	1.05	
Acoustic parameters	$p_{r, \alpha}$ at z_{MI} (MPa)	4.17					
	P (mW)		38.2		38.2		#
	P_{1x1} (mW)		22.6		22.6		
	z_s (cm)			0.8			
	z_b (cm)					0.8	
	z_{MI} (cm)	0.8					
	$z_{pii, \alpha}$ (cm)	0.8					
	f_{awf} (MHz)	7.56	9.26		9.26		#
Other information	prf (Hz)	3813					
	srr (Hz)	26.7					
	n_{pps}	1					
	$I_{pa, \alpha}$ at $z_{pii, \alpha}$ (W/cm ²)	467.0					
	$I_{spta, \alpha}$ at $z_{pii, \alpha}$ or $z_{sii, \alpha}$ (mW/cm ²)	11.7					
	I_{spta} at z_{pii} or z_{sii} (mW/cm ²)	17.3					
	p_r at z_{pii} (MPa)	5.14					
Operating controls	Exam type	Superficial	MSK		MSK		
	Optimization	Gen	Gen		Gen		
	Depth (cm)	2.5	4.5		4.5		
	MB/THI	Off/on	Off/off		Off/off		
	AQ zoom	—	—		—		
	Needle profiling	—	—		—		
	Variable sector	—	—		—		

Table 91. Transducer model: L19-5 Operating mode: Color/CPD

Index label		MI	TIS		TIB		TIC
			At surface	Below surface	At surface	Below surface	At surface
Maximum index value		1.52	1.46		1.46		(b)
Index component value			1.46	1.46	1.46	1.46	
Acoustic parameters	$p_{r, \alpha}$ at z_{MI} (MPa)	4.17					
	P (mW)		52.2		52.2		#
	$P_{1 \times 1}$ (mW)		43.1		43.1		
	z_s (cm)			—			
	z_b (cm)					—	
	z_{MI} (cm)	0.8					
	$z_{pii, \alpha}$ (cm)	0.8					
	f_{awf} (MHz)	7.56	6.79		6.79		#
Other information	prr (Hz)	3140					
	srr (Hz)	24.3					
	n_{pps}	1					
	$I_{pa, \alpha}$ at $z_{pii, \alpha}$ (W/cm ²)	467.0					
	$I_{spta, \alpha}$ at $z_{pii, \alpha}$ or $z_{sii, \alpha}$ (mW/cm ²)	9.5					
	I_{spta} at z_{pii} or z_{sii} (mW/cm ²)	14.1					
	p_r at z_{pii} (MPa)	5.14					
Operating controls	Exam type	Venous	Superficial		Superficial		
	Mode	Color	Color		Color		
	2D optimization/depth (cm)	Res/2.9	Gen/4.8		Gen/4.8		
	THI	On	Off		Off		
	Color optimization/PRF (Hz)	Medium/1866	Low/1667		Low/1667		
	Color box position/size	Default/wide	Default/default		Default/default		
	AQ zoom	—	—		—		
	Variable sector	—	—		—		

Table 92. Transducer model: L19-5 Operating mode: PW Doppler

Index label		MI	TIS		TIB		TIC
			At surface	Below surface	At surface	Below surface	At surface
Maximum index value		1.00	1.16		2.29		(b)
Index component value			1.16	0.85	1.16	2.29	
Acoustic parameters	$p_{r, \alpha}$ at z_{MI} (MPa)	2.46					
	P (mW)		40.7		40.7		#
	$P_{1 \times 1}$ (mW)		40.7		40.7		
	z_s (cm)			0.75			
	z_b (cm)					0.75	
	z_{MI} (cm)	0.5					
	$z_{pii, \alpha}$ (cm)	0.5					
	f_{awf} (MHz)	6.02	6.02		6.02		#
Other information	prf (Hz)	1563					
	srr (Hz)	—					
	n_{pps}	1					
	$I_{pa, \alpha}$ at $z_{pii, \alpha}$ (W/cm^2)	236.7					
	$I_{spta, \alpha}$ at $z_{pii, \alpha}$ or $z_{sii, \alpha}$ (mW/cm^2)	467.3					
	I_{spta} at z_{pii} or z_{sii} (mW/cm^2)	576.1					
	p_r at z_{pii} (MPa)	2.73					
Operating controls	Exam type	Nerve	Nerve		Nerve		
	Gate size (mm)	1	1		1		
	Gate position (cm)	Zone 3 (0.9)	Zone 12 (4.4)		Zone 12 (4.4)		
	PRF (Hz)	1562	3906		3906		
	TDI	—	—		—		

Table 93. Transducer model: L19-5 Operating mode: 2D + PW Doppler

Index label		MI	TIS		TIB		TIC
			At surface	Below surface	At surface	Below surface	At surface
Maximum index value		1.52	1.17		2.07		(b)
Index component value			1.17	0.90	1.17	2.07	
Acoustic parameters	$p_{r, \alpha}$ at z_{MI} (MPa)	4.73					
	P (mW)		41.2		41.2		#
	$P_{1 \times 1}$ (mW)		38.2		38.2		
	z_s (cm)			0.75			
	z_b (cm)					0.75	
	z_{MI} (cm)	0.85					
	$z_{pii, \alpha}$ (cm)	0.85					
	f_{awf} (MHz)	9.76	6.06		6.06		#
Other information	prf (Hz)	4688					
	srr (Hz)	24.4					
	n_{pps}	1					
	$I_{pa, \alpha}$ at $z_{pii, \alpha}$ (W/cm^2)	762.3					
	$I_{spta, \alpha}$ at $z_{pii, \alpha}$ or $z_{sii, \alpha}$ (mW/cm^2)	16.2					
	I_{spta} at z_{pii} or z_{sii} (mW/cm^2)	27.4					
	p_r at z_{pii} (MPa)	6.27					
Operating controls	Exam type	Venous	Venous		Venous		
	Optimization/depth (cm)	Gen/2.2	Gen/5.2		Gen/5.2		
	THI	On	On		On		
	Gate size (mm)	1	1		1		
	Gate position (cm)	Zone 1 (0.4)	Zone 12 (4.4)		Zone 12 (4.4)		
	PRF (Hz)	1562	6250		6250		

Table 94. Transducer model: L19-5 Operating mode: 2D + PW Doppler + Color

Index label		MI	TIS		TIB		TIC
			At surface	Below surface	At surface	Below surface	At surface
Maximum index value		1.52	1.18		1.87		(b)
Index component value			1.18	0.99	1.14	1.87	
Acoustic parameters	$p_{r, \alpha}$ at z_{MI} (MPa)	4.73					
	P (mW)		46.3		43.4		#
	$P_{1 \times 1}$ (mW)		38.5		37.9		
	z_s (cm)			0.75			
	z_b (cm)					0.75	
	z_{MI} (cm)	0.85					
	$z_{pii, \alpha}$ (cm)	0.85					
	f_{awf} (MHz)	9.76	6.06		6.04		#
Other information	prf (Hz)	3210					
	srr (Hz)	24.9					
	n_{pps}	1					
	$I_{pa, \alpha}$ at $z_{pii, \alpha}$ (W/cm ²)	762.3					
	$I_{spta, \alpha}$ at $z_{pii, \alpha}$ or $z_{sii, \alpha}$ (mW/cm ²)	11.1					
	I_{spta} at z_{pii} or z_{sii} (mW/cm ²)	18.7					
	p_r at z_{pii} (MPa)	6.27					
Operating controls	Exam type	Venous	Venous		Venous		
	2D optimization/depth (cm)	Gen/2.2	Res/5.2		Gen/5.2		
	THI	On	On		On		
	Color optimization/PRF (Hz)	—/2604	—/1562		—/2604		
	Gate size (mm)	1	1		1		
	Gate position (cm)	Zone 1 (0.4)	Zone 12 (4.4)		Zone 12 (4.4)		

Table 95. Transducer model: L19-5 Ophthalmic Operating mode: 2D

Index label		MI	TIS		TIB		TIC
			At surface	Below surface	At surface	Below surface	At surface
Maximum index value		0.17	0.02		0.02		(b)
Index component value			0.022	0.022	0.022	0.022	
Acoustic parameters	$p_{r, \alpha}$ at z_{MI} (MPa)	0.59					
	P (mW)		0.67		0.67		#
	$P_{1 \times 1}$ (mW)		0.37		0.37		
	z_s (cm)			—			
	z_b (cm)					—	
	z_{MI} (cm)	1.45					
	$z_{pii, \alpha}$ (cm)	1.45					
	f_{awf} (MHz)	12.58	12.34		12.34		#
Other information	prr (Hz)	5726					
	srr (Hz)	14.9					
	n_{pps}	3					
	$I_{pa, \alpha}$ at $z_{pii, \alpha}$ (W/cm ²)	18.0					
	$I_{spta, \alpha}$ at $z_{pii, \alpha}$ or $z_{sii, \alpha}$ (mW/cm ²)	0.6					
	I_{spta} at z_{pii} or z_{sii} (mW/cm ²)	1.4					
	p_r at z_{pii} (MPa)	1.09					
Operating controls	Exam type	Ophthalmic	Ophthalmic		Ophthalmic		
	Optimization	Res	Res		Res		
	Depth (cm)	4.1	6.0		6.0		
	MB/THI	On/off	On/off		On/off		
	AQ zoom	—	—		—		
	Needle profiling	—	—		—		
	Variable sector	—	—		—		

Table 96. Transducer model: L19-5 Ophthalmic Operating mode: 2D + M Mode

Index label		MI	TIS		TIB		TIC
			At surface	Below surface	At surface	Below surface	At surface
Maximum index value		0.16	0.02		0.02		(b)
Index component value			0.020	0.018	0.020	0.020	
Acoustic parameters	$p_{r, \alpha}$ at z_{MI} (MPa)	0.57					
	P (mW)		0.56		0.56		#
	$P_{1 \times 1}$ (mW)		0.33		0.33		
	z_s (cm)			0.75			
	z_b (cm)					0.9	
	z_{MI} (cm)	0.9					
	$z_{pii, \alpha}$ (cm)	0.9					
	f_{awf} (MHz)	12.45	12.41		12.41		#
Other information	prr (Hz)	3813					
	srr (Hz)	26.7					
	η_{pps}	1					
	$I_{pa, \alpha}$ at $z_{pii, \alpha}$ (W/cm ²)	15.9					
	$I_{spta, \alpha}$ at $z_{pii, \alpha}$ or $z_{sii, \alpha}$ (mW/cm ²)	0.2					
	I_{spta} at z_{pii} or z_{sii} (mW/cm ²)	0.5					
	p_r at z_{pii} (MPa)	0.83					
Operating controls	Exam type	Ophthalmic	Ophthalmic		Ophthalmic		
	Optimization	Res	Res		Res		
	Depth (cm)	1.4	4.1		4.1		
	MB/THI	Off/off	Off/off		Off/off		
	AQ zoom	—	—		—		
	Needle profiling	—	—		—		
	Variable sector	—	—		—		

Table 97. Transducer model: L19-5 Ophthalmic Operating mode: Color/CPD

Index label		MI	TIS		TIB		TIC
			At surface	Below surface	At surface	Below surface	At surface
Maximum index value		0.17	0.04		0.04		(b)
Index component value			0.036	0.036	0.036	0.036	
Acoustic parameters	$p_{r, \alpha}$ at z_{MI} (MPa)	0.42					
	P (mW)		1.47		1.47		#
	$P_{1 \times 1}$ (mW)		1.08		1.08		
	z_s (cm)			—			
	z_b (cm)					—	
	z_{MI} (cm)	0.7					
	$z_{pii, \alpha}$ (cm)	0.7					
	f_{awf} (MHz)	6.13	6.13		6.13		#
Other information	pr (Hz)	9063					
	srr (Hz)	24.8					
	n_{pps}	12					
	$I_{pa, \alpha}$ at $z_{pii, \alpha}$ (W/cm ²)	5.2					
	$I_{spta, \alpha}$ at $z_{pii, \alpha}$ or $z_{sii, \alpha}$ (mW/cm ²)	2.9					
	I_{spta} at z_{pii} or z_{sii} (mW/cm ²)	3.7					
	p_r at z_{pii} (MPa)	0.50					
Operating controls	Exam type	Ophthalmic	Ophthalmic		Ophthalmic		
	Mode	Color	Color		Color		
	2D optimization/depth (cm)	Res/2.9	Res/4.8		Res/4.8		
	THI	Off	Off		Off		
	Color optimization/ (Hz)	Medium/1645	Medium/2976		Medium/2976		
	Color box position/size	Default/default	Bottom/default		Bottom/default		
	AQ zoom	—	—		—		
Variable sector	—	—		—			

Table 98. Transducer model: L19-5 Ophthalmic Operating mode: PW Doppler

Index label		MI	TIS		TIB		TIC
			At surface	Below surface	At surface	Below surface	At surface
Maximum index value		0.15	0.10		0.19		(b)
Index component value			0.100	0.083	0.100	0.190	
Acoustic parameters	$p_{r, \alpha}$ at z_{MI} (MPa)	0.38					
	P (mW)		3.71		3.71		#
	P_{1x1} (mW)		3.50		3.50		
	z_s (cm)			0.6			
	z_b (cm)					0.6	
	z_{MI} (cm)	0.65					
	$z_{pii, \alpha}$ (cm)	0.65					
	f_{awf} (MHz)	6.01	6.01		6.01		#
Other information	prf (Hz)	1563					
	srr (Hz)	—					
	n_{pps}	1					
	$I_{pa, \alpha}$ at $z_{pii, \alpha}$ (W/cm ²)	5.2					
	$I_{spta, \alpha}$ at $z_{pii, \alpha}$ or $z_{sii, \alpha}$ (mW/cm ²)	21.0					
	I_{spta} at z_{pii} or z_{sii} (mW/cm ²)	28.0					
	p_r at z_{pii} (MPa)	0.44					
Operating controls	Exam type	Ophthalmic	Ophthalmic		Ophthalmic		
	Gate size (mm)	2	2		2		
	Gate position (cm)	Zone 5 (1.4)	Zone 13 (4.7)		Zone 13 (4.7)		
	PRF (Hz)	1562	10417		10417		
	TDI	—	—		—		

P5-1 acoustic output tables

Table 99. Transducer model: P5-1 Operating mode: 2D

Index label		MI	TIS		TIB		TIC
			At surface	Below surface	At surface	Below surface	At surface
Maximum index value		1.52	1.55		1.55		3.33
Index component value			1.55	1.55	1.55	1.55	
Acoustic parameters	$p_{r, \alpha}$ at z_{MI} (MPa)	2.18					
	P (mW)		174.3		174.3		147.8
	$P_{1 \times 1}$ (mW)		157.9		157.9		
	z_s (cm)			—			
	z_b (cm)					—	
	z_{MI} (cm)	1.0					
	$z_{pii, \alpha}$ (cm)	1.0					
	f_{awf} (MHz)	2.06	2.06		2.06		2.08
Other information	prr (Hz)	3100					
	srr (Hz)	100.0					
	n_{pps}	1					
	$I_{pa, \alpha}$ at $z_{pii, \alpha}$ (W/cm ²)	167.3					
	$I_{spta, \alpha}$ at $z_{pii, \alpha}$ or $z_{sii, \alpha}$ (mW/cm ²)	109.1					
	I_{spta} at z_{pii} or z_{sii} (mW/cm ²)	118.7					
	p_r at z_{pii} (MPa)	1.94					
Operating controls	Exam type	Cardiac	Cardiac		Cardiac		OB
	Optimization	Gen	Gen		Gen		Gen
	Depth (cm)	5.0	7.0		7.0		7.0
	MB/THI	Off/on	Off/on		Off/on		Off/on
	AQ zoom	Off	Medium/middle		Medium/middle		Small/middle
	Needle profiling	—	—		—		—
	Variable sector	Minimum	80%		80%		—

Table 100. Transducer model: P5-1 Operating mode: 2D + M Mode

Index label		MI	TIS		TIB		TIC
			At surface	Below surface	At surface	Below surface	At surface
Maximum index value		1.52	1.55		2.20		3.39
Index component value			1.55	1.50	1.44	2.20	
Acoustic parameters	$p_{r, \alpha}$ at z_{MI} (MPa)	2.18					
	P (mW)		171.3		164.4		146.7
	$P_{1 \times 1}$ (mW)		156.9		142.6		
	z_s (cm)			1.8			
	z_b (cm)					3.8	
	z_{MI} (cm)	1.0					
	$z_{pii, \alpha}$ (cm)	1.0					
	f_{awf} (MHz)	2.06	2.07		2.11		2.09
Other information	prr (Hz)	3556					
	srr (Hz)	44.4					
	η_{pps}	1					
	$I_{pa, \alpha}$ at $z_{pii, \alpha}$ (W/cm ²)	167.3					
	$I_{spta, \alpha}$ at $z_{pii, \alpha}$ or $z_{sii, \alpha}$ (mW/cm ²)	54.6					
	I_{spta} at z_{pii} or z_{sii} (mW/cm ²)	59.4					
	p_r at z_{pii} (MPa)	1.94					
Operating controls	Exam type	Cardiac	Cardiac		Abdomen		Abdomen
	Optimization	Gen	Gen		Gen		Gen
	Depth (cm)	5.0	7.0		11.0		7.0
	MB/THI	Off/on	Off/on		Off/on		Off/on
	AQ zoom	Off	Medium/middle		Small/middle		Small/middle
	Needle profiling	—	—		—		—
	Variable sector	80%	80%		—		—

Table 101. Transducer model: P5-1 Operating mode: Color/CPD

Index label		MI	TIS		TIB		TIC
			At surface	Below surface	At surface	Below surface	At surface
Maximum index value		1.49	1.59		1.59		3.32
Index component value			1.59	1.59	1.59	1.59	
Acoustic parameters	$P_{r, \alpha}$ at z_{MI} (MPa)	2.18					
	P (mW)		182.8		182.8		182.8
	$P_{1 \times 1}$ (mW)		158.0		158.0		
	z_s (cm)			—			
	z_b (cm)					—	
	z_{MI} (cm)	3.0					
	$z_{pii, \alpha}$ (cm)	3.0					
	f_{awf} (MHz)	2.13	2.10		2.10		2.10
Other information	prf (Hz)	1652					
	srr (Hz)	19.0					
	η_{pps}	1					
	$I_{pa, \alpha}$ at $z_{pii, \alpha}$ (W/cm ²)	168.4					
	$I_{spta, \alpha}$ at $z_{pii, \alpha}$ or $z_{sii, \alpha}$ (mW/cm ²)	10.4					
	I_{spta} at z_{pii} or z_{sii} (mW/cm ²)	12.1					
	P_r at z_{pii} (MPa)	2.60					
Operating controls	Exam type	OB	Abdomen		Abdomen		Abdomen
	Mode	Color	Color		Color		Color
	2D optimization/depth (cm)	Pen/5.0	Gen/11.0		Gen/11.0		Gen/11.0
	THI	Off	Off		Off		Off
	Color optimization/PRF (Hz)	Low/273	High/1894		High/1894		High/1894
	Color box position/size	Default/narrow-short	Default/narrow		Default/narrow		Default/narrow
	AQ zoom	Off	On		On		On
	Variable sector	—	—		—		—

Table 102. Transducer model: P5-1 Operating mode: PW Doppler

Index label		MI	TIS		TIB		TIC
			At surface	Below surface	At surface	Below surface	At surface
Maximum index value		1.52	1.54		4.20		3.50
Index component value			1.13	1.54	1.11	4.20	
Acoustic parameters	$p_{r, \alpha}$ at z_{MI} (MPa)	2.32					
	P (mW)		218.9		214.5		234.4
	$P_{1 \times 1}$ (mW)		114.0		117.8		
	z_s (cm)			2.4			
	z_b (cm)					3.4	
	z_{MI} (cm)	3.6					
	$z_{pii, \alpha}$ (cm)	3.6					
	f_{awf} (MHz)	233	2.09		2.09		2.08
Other information	prf (Hz)	1008					
	srr (Hz)	—					
	n_{pps}	1					
	$I_{pa, \alpha}$ at $z_{pii, \alpha}$ (W/cm ²)	285.8					
	$I_{spta, \alpha}$ at $z_{pii, \alpha}$ or $z_{sii, \alpha}$ (mW/cm ²)	379.0					
	I_{spta} at z_{pii} or z_{sii} (mW/cm ²)	689.4					
	p_r at z_{pii} (MPa)	3.00					
Operating controls	Exam type	Cardiac	Cardiac		Abdomen		Abdomen
	Gate size (mm)	1	5		5		2
	Gate position (mm)	46	220		140		254
	PRF (Hz)	1008	1953		2604		2604
	TDI	On	Off		—		—

Table 103. Transducer model: P5-1 Operating mode: CW Doppler

Index label		MI	TIS		TIB		TIC
			At surface	Below surface	At surface	Below surface	At surface
Maximum index value		0.09	1.14		3.87		2.62
Index component value			1.14	0.89	1.02	3.87	
Acoustic parameters	$p_{r, \alpha}$ at z_{MI} (MPa)	0.12					
	P (mW)		120.1		106.7		120.1
	P_{1x1} (mW)		120.1		106.7		
	z_s (cm)			1.8			
	z_b (cm)					2.8	
	z_{MI} (cm)	3.2					
	$z_{pii, \alpha}$ (cm)	3.2					
	f_{awf} (MHz)	2.00	2.00		2.00		2.00
Other information	prf (Hz)	1					
	srr (Hz)	—					
	n_{pps}	1					
	$I_{pa, \alpha}$ at $z_{pii, \alpha}$ (W/cm ²)	0.5					
	$I_{spta, \alpha}$ at $z_{pii, \alpha}$ or $z_{sii, \alpha}$ (mW/cm ²)	514.6					
	I_{spta} at z_{pii} or z_{sii} (mW/cm ²)	838.9					
	p_r at z_{pii} (MPa)	0.16					
Operating controls	Exam type	Cardiac	Cardiac		Cardiac		Cardiac
	Gate position (cm)	Zone 4 (6.1)	Zone 12 (25.4)		Zone 4 (6.1)		Zone 12 (25.4)

Table 104. Transducer model: P5-1 Orbital Operating mode: 2D

Index label		MI	TIS		TIB		TIC
			At surface	Below surface	At surface	Below surface	At surface
Maximum index value		0.15	0.02		0.02		0.04
Index component value			0.021	0.021	0.021	0.021	
Acoustic parameters	$p_{r, \alpha}$ at z_{MI} (MPa)	0.26					
	P (mW)		2.69		2.69		2.69
	$P_{1 \times 1}$ (mW)		1.74		1.74		
	z_s (cm)			—			
	z_b (cm)					—	
	z_{MI} (cm)	1.6					
	$z_{pii, \alpha}$ (cm)	1.6					
	f_{awf} (MHz)	2.92	2.56		2.56		2.56
Other information	prf (Hz)	11273					
	srf (Hz)	87.4					
	n_{pps}	1					
	$I_{pa, \alpha}$ at $z_{pii, \alpha}$ (W/cm ²)	3.1					
	$I_{sp\alpha, \alpha}$ at $z_{pii, \alpha}$ or $z_{sii, \alpha}$ (mW/cm ²)	0.6					
	$I_{sp\alpha}$ at z_{pii} or z_{sii} (mW/cm ²)	0.7					
	p_r at z_{pii} (MPa)	0.30					
Operating controls	Exam type	Orbital	Orbital		Orbital		Orbital
	Optimization	Gen	Pen		Pen		Pen
	Depth (cm)	5.0	5.0		5.0		5.0
	MB/THI	Off/off	Off/off		Off/off		Off/off
	AQ zoom	—	—		—		—
	Needle profiling	—	—		—		—
	Variable sector	—	—		—		—

Table 105. Transducer model: P5-1 Orbital Operating mode: 2D + M Mode

Index label		MI	TIS		TIB		TIC
			At surface	Below surface	At surface	Below surface	At surface
Maximum index value		0.15	0.02		0.02		0.03
Index component value			0.019	0.019	0.019	0.021	
Acoustic parameters	$p_{r, \alpha}$ at z_{MI} (MPa)	0.26					
	P (mW)		2.12		2.12		2.12
	$P_{1 \times 1}$ (mW)		1.40		1.40		
	z_s (cm)			1.4			
	z_b (cm)					1.4	
	z_{MI} (cm)	1.6					
	$z_{pii, \alpha}$ (cm)	1.6					
	f_{awf} (MHz)	2.92	2.92		2.92		2.92
Other information	prf (Hz)	10720					
	srr (Hz)	80.0					
	η_{pps}	1					
	$I_{pa, \alpha}$ at $z_{pii, \alpha}$ (W/cm ²)	3.1					
	$I_{spta, \alpha}$ at $z_{pii, \alpha}$ or $z_{sii, \alpha}$ (mW/cm ²)	0.6					
	I_{spta} at z_{pii} or z_{sii} (mW/cm ²)	0.7					
	p_r at z_{pii} (MPa)	0.30					
Operating controls	Exam type	Orbital	Orbital		Orbital		Orbital
	Optimization	Gen	Gen		Gen		Gen
	Depth (cm)	5.0	5.0		5.0		5.0
	MB/THI	Off/off	Off/off		Off/off		Off/off
	AQ zoom	—	—		—		—
	Needle profiling	—	—		—		—
	Variable sector	—	—		—		—

Table 106. Transducer model: P5-1 Orbital Operating mode: Color/CPD

Index label		MI	TIS		TIB		TIC
			At surface	Below surface	At surface	Below surface	At surface
Maximum index value		0.17	0.09		0.09		0.18
Index component value			0.088	0.088	0.088	0.088	
Acoustic parameters	$p_{r, \alpha}$ at z_{MI} (MPa)	0.25					
	P (mW)		9.81		9.81		9.81
	$P_{1 \times 1}$ (mW)		8.55		8.55		
	z_s (cm)			—			
	z_b (cm)					—	
	z_{MI} (cm)	3.6					
	$z_{pii, \alpha}$ (cm)	3.6					
	f_{awf} (MHz)	2.11	2.11		2.11		2.11
Other information	prf (Hz)	2071					
	srr (Hz)	7.3					
	η_{pps}	14					
	$I_{pa, \alpha}$ at $z_{pii, \alpha}$ (W/cm ²)	2.0					
	$I_{spta, \alpha}$ at $z_{pii, \alpha}$ or $z_{sii, \alpha}$ (mW/cm ²)	2.8					
	I_{spta} at z_{pii} or z_{sii} (mW/cm ²)	4.2					
	p_r at z_{pii} (MPa)	0.37					
Operating controls	Exam type	Orbital	Orbital		Orbital		Orbital
	Mode	Color	Color		Color		Color
	2D optimization/depth (cm)	Gen/31.0	Gen/5.0		Gen/5.0		Gen/5.0
	THI	Off	Off		Off		Off
	Color optimization/PRF (Hz)	Low/710	Low/1016		Low/1016		Low/1016
	Color box position/size		Top/wide-short		Top/wide-short		Top/wide-short
	AQ zoom	—	—		—		—
	Variable sector	—	—		—		—

Table 107. Transducer model: P5-1 Orbital Operating mode: PW Doppler

Index label		MI	TIS		TIB		TIC
			At surface	Below surface	At surface	Below surface	At surface
Maximum index value		0.17	0.16		0.40		0.32
Index component value			0.11	0.16	0.11	0.40	
Acoustic parameters	$p_{r, \alpha}$ at z_{MI} (MPa)	0.25					
	P (mW)		21.7		21.7		21.7
	P_{1x1} (mW)		11.3		11.3		
	z_s (cm)			2.2			
	z_b (cm)					3.6	
	z_{MI} (cm)	3.4					
	$z_{pii, \alpha}$ (cm)	3.4					
	f_{awf} (MHz)	2.10	2.09		2.09		2.09
Other information	pr_r (Hz)	3906					
	srr (Hz)	—					
	n_{pps}	1					
	$I_{pa, \alpha}$ at $z_{pii, \alpha}$ (W/cm ²)	2.0					
	$I_{spta, \alpha}$ at $z_{pii, \alpha}$ or $z_{sii, \alpha}$ (mW/cm ²)	29.0					
	I_{spta} at z_{pii} or z_{sii} (mW/cm ²)	48.2					
	p_r at z_{pii} (MPa)	0.31					
Operating controls	Exam type	Orbital	Orbital		Orbital		Orbital
	Gate size (mm)	3	5		5		5
	Gate position (cm)	Zone 3 (4.6)	Zone 10 (18.9)		Zone 10 (18.9)		Zone 10 (18.9)
	PRF (Hz)	3906	3125		3125		3125
	TDI	—	—		—		—

Terminology in acoustic output tables

Table 108. Acoustic output terminology

Term	Definition
α	Attenuation coefficient used for derating. Equal to 0.3 dB/cm/MHz ² .
f_{awf}	Acoustic working frequency.
$I_{pa, \alpha}$	Attenuated pulse-average intensity.
I_{spta}	Spatial-peak temporal-average intensity.
$I_{spta, \alpha}$	Attenuated spatial-peak temporal-average intensity.
MI	Mechanical index.
P	Output power.
P_{1x1}	Bounded-square output power.
$P_{r, \alpha}$	Attenuated peak-rarefactional acoustic pressure.
P_r	Peak-rarefactional acoustic pressure.
p_{ii}	Pulse-intensity integral.
$p_{ii, \alpha}$	Attenuated pulse-intensity integral.

Term	Definition
n_{pps}	Number of pulses per ultrasonic scan line.
prr	Pulse repetition rate.
srr	Scan repetition rate.
Tl	Thermal index.
TIB	Bone thermal index.
TIC	Cranial-bone thermal index.
TIS	Soft-tissue thermal index.
Z_b	Depth for TIB.
Z_{MI}	Depth for mechanical index.
Z_{pii}	Depth for peak pulse-intensity integral.
$Z_{pii, \alpha}$	Depth for peak attenuated pulse-intensity integral.
Z_{sii}	Depth for peak sum of pulse-intensity integrals.
$Z_{sii, \alpha}$	Depth for peak sum of attenuated pulse-intensity integrals.
Z_s	Depth for TIS.

Acoustic measurement precision and uncertainty

All table entries have been obtained at the same operating conditions that give rise to the maximum index value in the first row of the table. Measurement uncertainty for power, pressure, intensity, and other quantities that are used to derive the values in the acoustic output table are shown in the table below.

Table 109. Acoustic measurement uncertainty

Parameter	Uncertainty (95% confidence)		
	C5-1, IC10-3, P5-1,	L12-3, L15-4	L19-5
P_r	+11.2 to -9.3%	+12.5 to -12.3%	+13.4 to -13.1%
P_r	+11.2 to -9.4%	+12.5 to -12.3%	+13.5 to -13.2%
P	$\pm 11.7\%$	$\pm 11.7\%$	$\pm 16.2\%$
f_{awf}	$\pm 1.0\%$	$\pm 1.0\%$	$\pm 1.0\%$
P_{ii}	+19.4 to -14.1%	+21.8 to -21.3%	+24.1 to -23.2%
P_{ii}	+19.5 to -14.2%	+21.9 to -21.4%	+24.2 to -23.3%

IT Network

Functions

This device can be connected to an IT network to perform the following functions:

- Storing the examination data (static images, clips) acquired by this device in Picture Archiving and Communication System (PACS) by DICOM communication.
- Querying examination orders from the Modality Worklist (MWL) server by DICOM communication and starting them.
- Setting the time of this device by inquiring the network time service.
- Communicating procedure status via the Modality Performed Procedure Step (MPPS) service.
- Requesting transfer of responsibility for image ownership to another system via the Storage Commitment service.
- Downloading custom worksheet templates from a Sonosite Synchronicity server to download custom worksheet templates and using Qview to connect to a Qpath server to fill out remote worksheets.

Data backup

- Perform data backups regularly as part of your organization's disaster recovery plan. Doing so will help ensure proper system operation and data integrity. FUJIFILM Sonosite recommends that you allow only the authorized system administrator to back up the ePHI, audit log and system configurable data.
- Keep data backups on modern types of media to ensure data is not lost due to technology obsolescence.

Network specifications for connecting the device

To ensure safety, use an IT network that is isolated from the external environment by a firewall.

Hardware specification

- 802.11 a/b/g/n/ac
- Ethernet 10/100/1000 BASE-T using RJ45 port with patch cable

Interface and communication protocols

The following interface and communication protocols are available on the system:

- NTP
- DICOM
- DHCP
- HTTPS
- LDAP/S

NTP

Network Time Protocol (NTP) is widely used to synchronize the clocks of computers and network devices over a network, which is crucial for various applications and services.

Version: NTPv4 (as of RFC 5905)

Key components:

- **Timer servers:** Time servers are devices that provide accurate time information.
- **Clients:** Devices on the network that synchronize their clocks with time servers.
- **Messages:** NTP uses a series of messages exchanged between clients and servers to achieve time synchronization.
- **Stratum:** Time servers are classified into strata, with Stratum 1 servers having the most accurate time sources (e.g., atomic clocks). Stratum 2 servers synchronize with Stratum 1, and so on.
- **Time stamps:** NTP uses timestamps to represent time. Timestamps are based on a 64-bit format, which includes both seconds and fractions of a second.
- **Leap seconds:** NTP accounts for leap seconds, ensuring that devices can adjust their time accurately when leap seconds are introduced or removed.
- **Security considerations:** NTP includes security features to protect against cybersecurity attacks, such as unauthorized time adjustments.
- **Reference clocks:** Some NTP servers use reference clocks with extremely accurate time sources, like atomic clocks or GPS receivers.

NTP uses the following steps:

1. The client sends a request packet to a time server, asking for the current time.
2. The server responds with a packet containing its own notion of the current time. This packet also includes information about the server's stratum, precision, and other details.
3. The client adjusts its clock based on the received time information. The client may also use multiple servers and apply algorithms to improve accuracy and reliability.
4. Continuous polling and periodic updates occur to ensure ongoing synchronization.

DICOM

DICOM (Digital Imaging and Communications in Medicine) is a standard for the communication and management of medical imaging information and related data. For more information on DICOM and DICOM configuration, see [About DICOM \[43\]](#).

Version: DICOM 3.0

Key components: For a complete description of DICOM components, please refer to the *DICOM Conformance Statement* available at www.sonosite.com/support/connectivity.

- **Information Object Definitions (IODs):** DICOM defines various IODs that specify the structure and semantics of information entities, such as images, patient data, and study information.
- **Service classes:** DICOM includes different service classes that define specific operations and communication patterns. Examples include the Storage Service Class for image storage and the Query/Retrieve Service Class for querying and retrieving images.
- **Data elements:** DICOM uses a tag-based structure to represent data elements. Each data element has a unique tag that identifies it, and it includes information such as patient name, study date, pixel data, etc.
- **Transfer syntax:** DICOM supports different transfer syntaxes to encode and compress image and data information. Examples include JPEG, JPEG-LS, and explicit VR little-endian.

- **Network communication:** DICOM uses the DICOM Application Entity (AE) as a network node. Communication between DICOM nodes involves association establishment, negotiation of capabilities, and the exchange of information.
- **DICOM file format:** DICOM defines a file format for storing medical images and related information. The files often have a ".dcm" extension.
- **Security:** DICOM includes security features to protect patient privacy and ensure the confidentiality and integrity of medical data during transmission and storage.
- **SOP classes:** DICOM defines Service-Object Pair (SOP) Classes, which are combinations of IODs and service classes. SOP classes specify how instances of information objects are manipulated in a DICOM network.
- **Modality worklist:** DICOM supports the exchange of worklists, which contain information about scheduled procedures, patient demographics, and other relevant data.
- **Interoperability:** DICOM enables interoperability between different medical imaging devices, such as MRI machines, CT scanners, and PACS (Picture Archiving and Communication System) solutions.

DHCP

The Dynamic Host Configuration Protocol (DHCP) is a network management protocol that dynamically assigns and manages IP addresses, subnet masks, default gateways, domain name system (DNS) servers, and other network configuration information to devices on a TCP/IP network. DHCP simplifies the process of network administration by automating the assignment of IP addresses, reducing the likelihood of conflicts, and making it easier to manage changes to the network.

Key components:

- **DHCP server:** A server responsible for dynamically assigning IP addresses and related network configuration information to DHCP clients.
- **DHCP client:** A device (such as a computer, smartphone, or network printer) that requests network configuration information from a DHCP server.
- **Lease:** DHCP operates on a lease-based system where IP addresses are assigned to clients for a specific duration (lease time). Clients must renew their leases before expiration to maintain network connectivity.
- **IP address pool:** The range of IP addresses that the DHCP server is configured to allocate to clients. DHCP assigns IP addresses from this pool to clients upon request.
- **Scope:** A scope defines the configuration options and IP address range provided by a DHCP server for a specific subnet.
- **Offer, Request, Acknowledge (ORA) process:**
 1. The DHCP server offers an available IP address and other configuration parameters to a client.
 2. The client formally requests the offered IP address from the DHCP server.
 3. The DHCP server acknowledges the client's request and finalizes the lease.
- **Renewal process:** DHCP clients periodically attempt to renew their lease before it expires by requesting an extension from the DHCP server.
- **Release process:** Clients can release their assigned IP addresses back to the DHCP server when they are done using them, freeing up addresses in the pool.
- **Broadcast communication:** DHCP initially relies on broadcast communication for discovering available DHCP servers and obtaining initial configuration information. Unicast communication can be used later for lease renewal.

- **Options:** DHCP allows for the inclusion of various configuration options, such as DNS server addresses, default gateway, subnet mask, within the DHCP messages.
- **Dynamic configuration:** DHCP allows for changes to the network configuration without manual intervention, facilitating dynamic adaptation to network changes.

HTTPS

HTTPS (Hypertext Transfer Protocol Secure) is a secure version of HTTP, which is used for transmitting data on the World Wide Web. HTTPS adds encryption to protect the data exchanged between a user's web browser and a website. This encryption is typically implemented using Transport Layer Security (TLS) or its predecessor, Secure Sockets Layer (SSL).

Key components:

- **Encryption:** HTTPS uses encryption protocols, primarily TLS, to secure communication between the web server and the client's browser. This encryption ensures that data transmitted between the two entities remains confidential and cannot be easily intercepted by malicious actors.
- **URL scheme:** HTTPS URLs are distinguished from regular HTTP URLs by the "https://" prefix. This indicates that communication between the client and the server is secured.
- **Secure Socket Layer (SSL)/Transport Layer Security (TLS):** SSL and TLS are cryptographic protocols that provide secure communication over a computer network. They establish a secure connection by encrypting the data exchanged between the client and the server.
- **Public Key Infrastructure (PKI):** HTTPS relies on PKI to facilitate secure key exchange between the server and the client. This involves the use of public and private key pairs.
- **Digital certificates:** Websites using HTTPS are required to have a digital certificate issued by a trusted Certificate Authority (CA). The certificate includes the public key and information about the website's owner, and it is used to verify the authenticity of the website.
- **Handshake process:** During the TLS/SSL handshake, the client and server negotiate the encryption algorithms and exchange cryptographic keys to establish a secure connection.
- **Data integrity:** In addition to encryption, HTTPS ensures data integrity by using cryptographic hash functions. This prevents data from being tampered with during transmission.
- **Port number:** HTTPS uses port 443 as the default port for secure communication as opposed to the default port 80 used by regular HTTP.
- **Mixed content warning:** To ensure that all elements of a page are secure, modern browsers issue warnings when a web page served over HTTPS contains resources (such as images or scripts) loaded over an insecure HTTP connection.
- **Browser indicators:** Through visual cues such as a padlock icon in the address bar, browsers can help users identify when their communication with a website is encrypted.

LDAP/S

LDAP/S (Secure Lightweight Directory Access Protocol) is a secure form of LDAP, which is used for accessing and managing directory information services. This encryption is typically implemented using Transport Layer Security (TLS) or its predecessor, Secure Sockets Layer (SSL).

Key components:

- **Lightweight Directory Access Protocol (LDAP):** LDAP is a directory service protocol that provides a standardized way to access and manage information in a directory, which is a hierarchical structure that organizes and stores data.
- **Secure connection:** LDAP/S ensures the security of communication between LDAP clients and servers by encrypting the data exchanged during the LDAP sessions.

- **Encryption protocols:** LDAP/S uses protocols such as SSL or TLS to provide encryption for data in transit.
- **Port number:** LDAP/S uses port 636 as the default port for secure communication as opposed to the default port 389 used by regular LDAP.
- **Certificate-based authentication:** LDAP/S often involves certificate-based authentication, where the server presents a digital certificate to prove its identity to the client, and the client may also present its own certificate.
- **TLS handshake:** During the TLS handshake, the client and server negotiate encryption settings and exchange cryptographic keys, establishing a secure connection.
- **Directory services:** LDAP/S is commonly used for accessing and managing directory services, which store and organize information such as user profiles, network resources, and other types of structured data.
- **Security considerations:** LDAP/S helps protect sensitive information from eavesdropping and tampering during transmission over a network, enhancing the overall security of directory services.
- **Compatibility:** LDAP/S maintains compatibility with standard LDAP operations and functionality, ensuring that secure connections can be established without significant changes to LDAP-based applications.

Security and privacy

- The port for DICOM communication (specified by the user in the system settings; typically port 104, 2762, or 11112) is used for outgoing communication to the network.
- Anti-virus software is not installed on this device.
- This device has a single configurable listening port for the purposes of DICOM Echo and Storage Commitment.
- The security and privacy-related configurable controls in Sonosite ST are:
 - User roles and responsibilities
 - Automatic user log off
 - User authorization and authentication
 - Data backup and recovery
 - Data encryption (at rest and in transit)
- System and department administrators should follow the suggested technical and physical safeguards listed below, as well as the detailed HIPAA guidelines to ensure HIPAA compliance:
 - **Room Access Control:** Local procedures must be put in place to limit physical access to medical equipment, to prevent accidental, casual, or deliberate contact by unauthorized individuals.
 - **System Access Controls:** Access the system only through unique user accounts. Login credentials must not be disclosed.
 - **Audit Controls:** Each user action associated with patient data will be tracked through ePHI audit logs, which are accessible to and should be routinely audited by the administrator. Guest user accounts cannot be audited and should only be used when required.
 - **De-identification:** Use a de-identification option before exporting patient data to removable media used for system troubleshooting or repair.
 - **Removable media handling:** Removable media that contains images or other medical information must be stored in a secure area that is not accessible by unauthorized individuals.
 - **Transmission Security:** Clinical data transmitted over the network may not be encrypted. Add only trusted devices to the network. (We highly recommend the use of encrypted DICOM.

If secure DICOM is not supported, then network security controls shall be implemented to protect integrity and confidentiality of data).

- **Data Integrity:** Cryptographic methods should be used at all times to ensure the integrity of personal data. When possible, perform integrity checks to identify unauthorized changes in personal data. In case there is suspicion of improperly altered or destroyed clinical data, notify FUJIFILM Sonosite service.
- **Data Encryption:** Data at rest should be encrypted at the disk level as well as the database level with a valid FIPS 140-2 compliant encryption method. Encryption keys should be kept secured and maintained only by system administrators.
- **System Hardening:** The application and database hosting server(s) should be hardened according to the NIST 800-123 server security controls.
- **Software Updates:** Only FUJIFILM Sonosite authorized updates and/or patches should be applied to the medical device.

Data flow

MWL Server —————> Sonosite ST —————> PACS

Study order (DICOM MWL)—————Study data (DICOM Storage)

Please refer to the *DICOM Conformance Statement* for details.



CAUTION

1. Connection of equipment to an IT network that includes other systems could result in previously unidentified risks to patients, operators or third parties. Before connecting the equipment to an uncontrolled IT Network, make sure that all potential risks resulting from such connections were identified and evaluated, and suitable countermeasures were put in place. IEC 80001-1:2010 provides guidance for addressing these risks.
2. When a setting of the IT network to which this device is connected has been changed, check that the change does not affect this device and take measures if necessary. Changes to the IT network include:
 - Changes in network configuration (IP address, router etc.)
 - Connection of additional items
 - Disconnection of items
 - Update of equipment
 - Upgrade of equipment

Any changes to the IT network could introduce new risks requiring additional evaluation to be performed as per item 1 above.

Application approved list

The application approved list prevents unauthorized use of the ultrasound system.

- The system only allows execution of software that is configured in the application approved list.
- The system blocks attempts to change, overwrite or delete all files that are included in the application approved list.

- The application approved list is not configurable by the user. This configuration is part of the FUJIFILM Sonosite software installation process.
- The system only allows a change in the application approved list when the change is initiated by a digitally signed software component, such as a FUJIFILM Sonosite update.
- The system logs any attempt to change or delete approved files.
- The system logs any attempt to change the application approved configuration.
- The system logs any attempt to load or execute unauthorized software files.
- System logs should be routinely audited by the administrator.

IT network failure recovery measures

Connection to an IT network may become, at times, unreliable, and this may lead to failure to perform the functions described in [Functions \[256\]](#). As a result, the following hazardous situations may occur.

Network failure	Impact on equipment	Hazard	Countermeasure
IT network becomes unstable (for example, wireless communication fails)	Unable to transmit exam data to a PACS	Delay of diagnosis	The ultrasound system has internal memory, and exam data is stored in it. After the IT network has returned to stable, the system automatically re-initiates the transfer of data.
	Delay of transmission to a PACS		
	Incorrect data transmitted to a PACS	Misdiagnosis	Integrity of the data is ensured by the TCP/IP and DICOM Protocols used by the system.
	Unable to get order data from an MWL server	Delay of exam	The user can initiate/create a new study on the system.
	Delay of getting order from an MWL server		
	Incorrect data from a MWL server	Incorrect exam	The ultrasound system uses the TCP/IP and DICOM Protocols, which ensures data integrity.
	Unable to get the time from a time server.	Incorrect exam data	The ultrasound system has the capability of entering data and time manually.
	Incorrect time data		The ultrasound system always indicates the date and the time on the main screen.
Firewall has broken down	Attack via network	Manipulation of exam data	The ultrasound system closes unnecessary network ports.
	Infection by computer virus	Leak of exam data	The ultrasound system prevents a user from loading software and executing it.

If the network connection fails due to network facility issues, the system retries the transmission of study data to the PACS systems. After the system retries sending the study four times, the system pauses the transmission. If transmission is paused, the system automatically resumes transmission after a configured period of time (see [Location configuration fields \[45\]](#)). The system automatically suspends transmission if an unexpected error is encountered. If transmission is suspended, transmission must be manually re-activated by the user (see [Manually archiving studies \[123\]](#)). Transmission for both paused and suspended studies can be re-activated by the user at any time. There is no risk to patient safety, operator or bystander, as well as no data loss as the system buffers all data locally. The system can perform its intended clinical function even without a network connection.

Wireless connectivity

If FIPS (Federal Information Processing Standards) is enabled, the Quality of Service (QoS) is turned off on the ultrasound system. The system does not have a user interface to change the QoS for networking settings, and the system's wireless functionality is not affected by any settings present on other network devices and servers.

To use a wireless connection, wireless settings must be configured following instructions in the **Connectivity and DICOM** settings section and subsections. Specific wireless connections and setting fields are described in [Connecting to the network wirelessly \[44\]](#), [Location configuration fields \[45\]](#), and [Wireless profile configuration fields \[46\]](#). Multiple wireless profiles can be configured following these instructions. After configuring and enabling the network connection, the system automatically restarts and connects to the configured network. If the connection is

lost, the system displays the following wireless icon . You do not need to take any action to reconnect to the lost wireless connection. The system automatically retries connecting to the network without having to restart the system, and re-establishes the connection once the wireless signal is available again. There is no data loss in these instances as the system buffers all the data locally. Reactivation and recovery assume that the wireless profile and location settings are configured correctly, and the wireless network is working properly.

Implementing, detecting, and maintaining security

To ensure secure use of your system, implement **Secure mode** (see [Configuring the system for the first time \[31\]](#)).

To prevent cybersecurity threats, the system is hardened, contains an internal firewall, and uses the approved application list. If a vulnerability/exploit is discovered that reaches a level that could impact your ultrasound system, FUJIFILM Sonosite executes its incident response plan, which includes customer notification and the provisions of preventive and corrective action plans. If you suspect or detect a cybersecurity event on your system, please contact FUJIFILM Sonosite Technical Support (see [Getting help \[2\]](#)), which prompts FUJIFILM Sonosite to execute its incident response plan.

FUJIFILM Sonosite routinely provides updated software which contains the latest cybersecurity patches. FUJIFILM Sonosite encourages you to maintain a high level of security by keeping the system up to date with released software versions. Information about the latest version of the system software is made available to customers through the field and service representatives who distribute release notes to customers for each release when the device is available for sale in the region. Instructions for software licensing upgrades are further described in [Software licensing \[152\]](#).

Glossary

Terms

For ultrasound terms not included in this glossary, refer to *Recommended Ultrasound Terminology, Third Edition*, published in 2011 by the American Institute of Ultrasound in Medicine (AIUM).

ACEP	American College of Emergency Physicians
as low as reasonably achievable (ALARA)	The guiding principle of ultrasound use, which states that you should keep patient exposure to ultrasound energy as low as reasonably achievable for diagnostic results.
bone thermal index (TIB)	A thermal index for applications in which the ultrasound beam passes through soft tissue and a focal region is in the immediate vicinity of bone.
cranial bone thermal index (TIC)	A thermal index for applications in which the ultrasound beam passes through bone near the beam entrance into the body.
depth	Refers to the depth of the display. A constant speed of sound of 1538.5 meters/second is assumed in the calculation of echo position in the image.
D-line	Refers to the focus position of the ultrasound beam during Doppler imaging.
<i>in situ</i>	In the natural or original position.
mechanical index MI	An indication of the likelihood of mechanical bioeffects occurring: the higher the MI, the greater the likelihood of mechanical bioeffects.
M-line	Refers to the focus position of the ultrasound beam during M Mode imaging.
pulse repetition frequency (PRF)	Indicates the number of ultrasound pulses emitted by the transducer over a designated period of time. HPRF stands for high pulse repetition frequency.
skinline	A depth on the display that corresponds to the skin/transducer interface.
soft tissue thermal index (TIS)	A thermal index related to soft tissues.
SonoMB technology	A subset of the 2D imaging mode in which the 2D image is enhanced by looking at a target from multiple angles and then merging or averaging the scanned data together to improve overall image quality and, in parallel, reducing noise and artifacts.
thermal index (TI)	The ratio of total acoustic power to the acoustic power required to raise tissue temperature by 1°C under defined assumptions.

Tissue Doppler Imaging (TDI)	A pulsed wave Doppler technique used to detect myocardial motion.
Tissue Harmonic Imaging (THI)	Transmits at one frequency and receives at a higher harmonic frequency to reduce noise and clutter and improve resolution.
transducer	A device that transforms one form of energy into another form of energy. Ultrasound transducers contain piezoelectric elements, which when excited electrically, emit acoustic energy. When the acoustic energy is transmitted into the body, it travels until it encounters an interface, or change in tissue properties. At the interface, an echo is formed that returns to the transducer, where this acoustic energy is transformed into electrical energy, processed, and displayed as anatomical information.
curved array transducer	Identified by the letter C (curved or curvilinear) and a number. The number corresponds to the frequency range of the transducer expressed in MHz. The transducer elements are electrically configured to control the characteristics and direction of the acoustic beam. For example, C5-1.
linear array transducer	Identified by the letter L (linear) and a number. The number corresponds to the frequency range of the transducer expressed in MHz. The transducer elements are electrically configured to control the characteristics and direction of the acoustic beam. For example, L12-3.
phased array transducer	Identified by the letter P (phased) and a number. A transducer designed primarily for cardiac scanning. Forms a sector image by electronically steering the beam direction and focus. For example, P5-1.
variance	Displays a variation in Color Doppler flow imaging within a given sample. Variance is mapped to the color green and is used to detect turbulence.

Abbreviations

Abbreviations in the user interface.

A	"A" Wave Peak Velocity
A2Cd	Apical 2 Chamber diastolic
A2Cs	Apical 2 Chamber systolic
A4Cd	Apical 4 Chamber diastolic
A4Cs	Apical 4 Chamber systolic
AAA	Abdominal Aortic Aneurysm
AAo or Asc Ao	Ascending Aorta

Abd	Abdomen
AC	Abdominal Circumference
ACA	Anterior Cerebral Artery
ACoA or A Com A	Anterior Communicating Artery
ACS	Aortic Valve Cusp Separation
Adur	"A" wave duration
AFI	Amniotic Fluid Index
AI	Aortic Insufficiency
AI PHT	Aortic Insufficiency Pressure Half Time
Ann D	Annulus Diameter
Ant F	Anterior Far
Ant N	Anterior Near
Ao	Aorta
Ao D	Aortic Root Diameter
A PG	"A" Wave Peak Pressure Gradient
APTD	Anteroposterior Trunk Diameter
Art	Artery
AS	Aortic Stenosis
AT	Acceleration (Deceleration) Time
ATFL	Anterior Talofibular Ligament
AUA	Average Ultrasound Age. Calculated by averaging the individual ultrasound ages for the fetal biometry and mean gestational sac (MGS) measurements performed during the exam. The gestational age (GA) values used to determine the AUA are based on the selected OB calculation authors.
AV	Aortic Valve
AVA	Aortic Valve Area
BA	Basilar Artery
Bifur	Bifurcation
BP	Blood Pressure
BPD	Biparietal Diameter

BPM	beats per minute
BPP	Biophysical Profile
Bre	Breast
BSA	Body Surface Area
CBD	Common Bile Duct
CCA	Common Carotid Artery
CHD	Common Hepatic Duct
CI	Cardiac Index
CIA	Common Iliac Artery
Cine	Cine buffer or loop. The cine buffer stores a sequence of images recorded over a certain time frame.
CM	Cisterna Magna
CO	Cardiac Output
Cons/Eff	Pulmonary Consolidation/Pleural Effusion
CPD	Color Power Doppler
Crd	Cardiac
CRL	Crown Rump Length
CVD	Color Velocity Doppler
CVR	Catheter to vessel ratio
CW	Continuous Wave Doppler
Cx Len	Cervix Length
D Apical	Distance Apical
DCCA	Distal Common Carotid Artery
DECA	Distal External Carotid Artery
Decel	Deceleration time
DICA	Distal Internal Carotid Artery
Dist	Distal
D or d	Diastolic
D or Diam	Diameter

dP/dt	Delta Pressure/Delta Time
E	"E" Wave Peak Velocity
E:A	E:A Ratio
ECA	External Carotid Artery
ECICA	Extracranial Internal Carotid Artery
ECVA	Extracranial Vertebral Artery
EDA	End Diastolic Area
EDD	Estimated Date of Delivery
EDD by AUA	Estimated Date of Delivery by Average Ultrasound Age The estimated date of delivery calculated from the measurements performed during the exam.
EDD by LMP	Estimated Date of Delivery by Last Menstrual Period The due date calculated from the user-entered LMP.
EDV	End Diastolic Velocity
E/e'	E velocity = Mitral Valve E velocity divided by the annular e' velocity
EF	Ejection Fraction
EFW	Estimated Fetal Weight Calculated from the measurements performed during the exam. The measurements used to determine EFW are defined by the currently selected EFW calculation author.
EIA	External Iliac Artery
Endo	Endocardial
E PG	"E" Wave Peak Pressure Gradient
Epi	Epicardial
EPSS	"E" Point Septal Separation
ESA	End Systolic Area
ESI	Epidural Steroid Injection
Estab.DD	Established Due Date A user-entered due date based on previous exam data or other available information. The LMP is derived from the Established Due Date and is listed in the patient report as LMPd.

ET	Ejection Time
FAC	Fractional Area Change
FHR	Fetal Heart Rate
FL	Femur Length
Foll	Follicle
FS	Fractional Shortening
FTA	Fetal Trunk Area
GA	Gestational Age
GA by LMP	Gestational Age by Last Menstrual Period The fetal age calculated using the date of the Last Menstrual Period (LMP).
GA by LMPd	Gestational Age by derived Last Menstrual Period The fetal age calculated using the Last Menstrual Period (LMPd) derived from the Estab. DD.
Gate	Depth of Doppler Gate
GB	Gallbladder
Gest	Gestational
GS	Gestational Sac
GSV	Great Saphenous Vein
Gyn	Gynecology
H	Height
HC	Head Circumference
HL	Humerus Length
HR	Heart Rate
HV	Hepatic Vein
IAS	Interatrial Septum
ICA	Internal Carotid Artery
IIA	Internal Iliac Artery
IJV	Internal Jugular Vein
IMT	Intima Media Thickness

IOD	Inner Ocular Distance
IRV	Intrarenal Vein
IVC	Inferior Vena Cava
IVC Max D	Inferior Vena Cava Maximum Diameter
IVCT	Isovolumic Contraction Time
IVRT	Isovolumic Relaxation Time
IVS	Interventricular Septum
IVSd	Interventricular Septum Diastolic
IVS FT	Interventricular Septum Fractional Thickening
IVSs	Interventricular Septum Systolic
L	Length
LA	Left Atrium
Lat F	Lateral Far
Lat N	Lateral Near
Lat Vent	Lateral Ventricle
LCL	Lateral Collateral Ligament
LMP	Last Menstrual Period
	The first day of the last menstrual period. Used to calculate gestational age and EDD.
LMPd	derived Last Menstrual Period
	Calculated from the user-entered Estab. DD.
LSV	Long Saphenous Vein
Lt	Left
LV	Left Ventricular
LVd	Left Ventricular diastolic
LVD	Left Ventricular Dimension
LVDd	Left Ventricular Dimension Diastolic
LVDFS	Left Ventricular Dimension Fractional Shortening
LVDs	Left Ventricular Dimension Systolic

LVEDV	Left Ventricular End Diastolic Volume
LVESV	Left Ventricular End Systolic Volume
LVET	Left Ventricular Ejection Time
LVO	Left Ventricular Opacification
LVOT	Left Ventricular Outflow Tract
LVOT D	Left Ventricular Outflow Tract Diameter
LVPW	Left Ventricular Posterior Wall
LVPWd	Left Ventricular Posterior Wall Diastolic
LVPWFT	Left Ventricular Posterior Wall Fractional Thickening
LVPWs	Left Ventricular Posterior Wall Systolic
LVs	Left Ventricular systolic
MB	SonoMB technology
MCA	Middle Cerebral Artery
MCCA	Mid Common Carotid Artery
MCL	Medial Collateral Ligament
MDV	Minimum diastolic velocity
MECA	Mid External Carotid Artery
MICA	Mid Internal Carotid Artery
MS	Mitral Stenosis
Msk	Musculoskeletal
MV	Mitral Valve
MVA	Mitral Valve Area
MV ERO	Mitral Valve Effective Regurgitant Orifice
Neo	Neonatal
NRV	Nerve
NST	Non-Stress Test
NT	Nuchal Translucency
OA	Ophthalmic Artery
OFD	Occipital Frontal Diameter

ONSD	Optic Nerve Sheath Diameter
OOD	Outer Occular Distance
Oph	Ophthalmic
Orb	Orbital
PAL	Phase Alternating Line
PCA P	Posterior Cerebral Artery Peak
PCCA	Proximal Common Carotid Artery
PCoA, PCOA, P Com A	Posterior Communicating Artery
PECA	Proximal External Carotid Artery
Ped	Pediatric
PF	Pulsatility Fraction
PG	Pressure Gradient
PHT	Pressure Half Time
PI	Pulsatility Index
PICA	Proximal Internal Carotid Artery
PISA	Proximal Isovelocity Surface Area
PIV	Peripheral Intravenous
Plaq	Plaque
Post F	Posterior Far
Post N	Posterior Near
Post-v or PV	Post-void
Pre-v	Pre-void
Pro	Prostate
Proc	Procedural
Prox	Proximal
PSIS	Posterior Superior Iliac Spine
PSV	Peak Systolic Velocity
PV	Portal Vein
	Pulmonic Valve

P Vein or PVn	Pulmonary Vein
PW	Pulsed Wave Doppler
Qp/Qs	Pulmonary blood flow divided by systemic blood flow
RA	Right Atrial
RAP	Right Atrial Pressure
RCA	Right Coronary Artery
RFID	Radio-Frequency Identification
RI	Resistive Index
RIMP	Right Ventricular Index of Myocardial Performance
Rt	Right
RV	Right Ventricular
RVD	Right Ventricular Dimension
RVDd	Right Ventricular Dimension Diastolic
RVDs	Right Ventricular Dimension Systolic
RVOT D	Right Ventricular Outflow Tract Diameter
RVSP	Right Ventricular Systolic Pressure
RVW	Right Ventricular Free Wall
RVWd	Right Ventricular Free Wall Diastolic
RVWs	Right Ventricular Free Wall Systolic
S'	Tricuspid Lateral Annular Systolic Velocity (TDI measurement)
S/D	Systolic/Diastolic Ratio
SI	Stroke Index
Sinus Val D	Sinus of Valsalva Diameter
Siphon	Siphon (internal carotid artery)
SMP	Small Parts
STJ D	Sino Tubular Junction Diameter
Sup	Superficial
SV	Stroke Volume
TAM	Time Average Mean

TAP	Time Average Peak
TAPSE	Tricuspid Annular Plane Systolic Excursion: M Mode distance measurement of systolic excursion of the right ventricle
TAV	Time Average Velocity
TCD	Trans-cerebellum Diameter (OB measurement) Transcranial Doppler (exam type)
TICA	Terminal Internal Carotid Artery
TL	Tibia Length
TO	Transorbital
Trans	Transverse
TR Vmax	Tricuspid Regurgitation (peak velocity)
TT	Transtemporal
TTD	Transverse Trunk Diameter
TV	Tricuspid Valve
TVA	Tricuspid Valve Area
UA	Ultrasound Age Calculated on the mean measurements taken for a particular fetal biometry.
UmbA	Umbilical Artery
VA	Vertebral Artery
Vasc	Vascular
Ven	Venous
VF	Volume Flow
VMax	Peak Velocity
VMean	Mean Velocity
Vol	Volume
VTI	Velocity Time Integral
W	Width
YS	Yolk Sac

Index

Symbols

2D

- controls, 69
- definition, 68
- imaging or scanning, 69
- measurements, 94

A

- abdominal
 - calculations, 101
 - circumference (AC), 145
 - exam type, 26
 - intended use, 7
 - procedural, 26
 - settings, 51
- accessories, 13, 182
 - clean and disinfect, 167
- acoustic output
 - measurement, 199
 - terms, 254
- administrator
 - configure system, 31
 - log in and log out, 32
 - worksheet, 38
- ALARA, principle, 195
- amniotic fluid index (AFI), 117, 144
- angle
 - D-line, 72, 73
 - measurement, 96
- aortic valve area (AVA), 113, 131
- archive
 - DICOM, 47, 122
 - exam or study, 122, 123
 - images and clips, 90
 - manual, 123
 - status, 123
 - verify, 122
- area
 - ellipse, 95
 - trace, 95
- arterial
 - exam type, 26
 - intended use, 8
- atrial volume, 110, 135
- audio, 42

- audit controls, 260
- auto delete, 37
- auto gain, 77
- auto trace, 99, 100
- average ultrasound age (AUA), 116, 145

B

- barcode
 - patient, 63
 - worklist, 57, 63
- battery
 - about, 192
 - indicators, 17
 - install or replace, 16
 - safety, 175
 - settings, 55
- biometrics
 - enter, 62
 - measurements, 9
 - obstetrics, 117
- biparietal diameter (BPD), 117, 146
- bladder, 51, 150
- body surface area (BSA), 62, 132
- breast
 - exam type, 26
 - intended use, 8

C

- calculations
 - abdominal, 101
 - about, 92
 - carotid, 114
 - CVR setup, 51
 - delete from report, 127
 - gynecology, 115, 116
 - hip angle, 120
 - hip ratio, 120
 - modify, 126
 - musculoskeletal (MSK), 120
 - obstetrics, 117
 - obstetrics setup, 50, 51
 - volume, 96
 - volume flow, 100, 101

- calipers
 - using, 92
- cardiac
 - exam type, 26
 - intended use, 7
 - references, 131
 - transesophageal, 9
- cardiac calculations
 - atrial volume, 110
 - CO and CI, 109
 - dP/dT, 113
 - ejection fraction (EF), 109
 - FAC, 108
 - IVC, 112
 - LV mass, 111
 - LV volume, 109
 - MAPSE or TAPSE, 110
 - pressure half time (PHT), 111
 - QpQs, 110
 - RAP, 113
 - SV and SI, 109
 - TDI waveform, 112
 - velocity time integral (VTI), 107
- cardiac index (CI), 109
- cardiac output (CO), 109
- carotid
 - calculations, 114
 - exam type, 26
 - intended use, 8
 - reference, 147
- cautions, definition, 1
- centerline, 80, 81
- cephalic
 - index (CI), 145
 - intended use, 7
- cine, 78
- circumference
 - ellipse, 95
 - trace, 95
- clean and disinfect
 - accessories, 167
 - definitions, 158
 - mode, 159, 163
 - Spaulding classifications, 157

- system, stand, and transducer, 158, 162
- clips
 - play, 128
 - save, 87
 - settings, 86
- Color
 - controls, 75
 - definition, 68
 - imaging or scanning, 74
 - steering, 75
 - types, 74
- configuration wizard, 31
- controls
 - 2D, 69
 - acoustic output, 196
 - acoustic power, 70
 - Color, 75
 - customize, 68
 - Doppler, 73
 - gain, 77
 - imaging or scanning, 68
 - M Mode, 71
 - more, 68
 - needle guide, 84, 85
 - voice, 24, 79
- cords, power, 183
- crown rump length (CRL), 146
- custom
 - controls, 68
 - exam type, 51, 52
 - worksheet, 38, 125, 126
- D**
- D-line
 - angle, 72, 73
 - gate size, 72, 74
 - steering, 72
- data
 - backup, 122, 124, 154, 155
 - edit, 66
 - enter, 61, 62, 63, 65
 - integrity, 261
 - review, 66
 - save, 66
- depth
 - adjust, 77
- DICOM
 - archive, 47
 - configure, 43, 44

- log, 59
- MPPS, 48
- standards, 193
- storage commit, 48
- distance
 - 2D, 94
 - M Mode, 97, 108
- document, conventions used, 1
- Doppler
 - controls, 73
 - definition, 68
 - gate size, 72, 74
 - imaging or scanning, 72
 - measurements, 97
 - modes, 72
 - sweep speed, 74
 - trace, 99
- dual mode, 76
- E**
- ejection fraction (EF), 109
- electrical, 170, 173, 193
- electromagnetic compatibility, 177, 180, 193
- error
 - acquisition, 131
 - algorithmic, 131
 - measurement, 130
 - message, 59, 152
- estimated due date (EDD), 117, 145
- estimated fetal weight (EFW), 51, 117, 145
- ethernet, 44
- exam
 - append, 122
 - archive, 122
 - custom, 51, 52
 - delete, 122
 - end, 61
 - export, 124
 - review, 122
 - select, 21, 26
- export
 - disable or enable, 36
 - exam or study, 124
 - images and clips, 90
 - logs, 60
 - settings, 50, 53, 57, 58

- F**
- factory reset, 30, 41
- follicles, 115, 116
- G**
- gain
 - adjust, 77
 - auto, 77
 - reset, 78
- gate size, 72, 74
- gel, 28
- gestational
 - intended use, 9
- gestational measurements, 117, 118, 119
 - references, 144, 145, 147
 - settings, 50, 51
 - tables, 50
- gynecology
 - calculations, 115, 116
 - exam type, 26
 - intended use, 8, 9
- H**
- hardware, 12
- heart rate
 - fetal, 118
 - measure, 97, 98
 - reference, 134
- hip
 - measurements, 120
 - reference, 148
- HIPAA, 194
- humidity limits, 191
- I**
- images and clips
 - append, 122
 - archive, 90
 - export, 58, 90
 - formats, 58
 - image gallery, 91
 - label, 87, 128
 - print, 89, 90
 - review, 127
 - save, 86, 87
- import
 - certificates, 40
 - settings, 50, 53
 - worksheets, 38
- intended use

- abdominal, 7
- cardiac, 7
- cephalic, 7
- gestational, 9
- gynecology, 8, 9
- lung, 7
- musculoskeletal (MSK), 8
- obstetrics, 8, 9
- ophthalmic, 8
- pediatric, 8
- peripheral vessel, 8
- prostate, 9
- small organs, 8

intensities, acoustic, 199

K

keyboard, 24

L

labels

- delete, 89
- display, 87
- move or edit, 87
- pictographs, 88
- predefined, 87
- review, 128
- settings, 87
- text, 87

LDAP/AD, 34

left ventricular (LV)

- ejection fraction (EF), 136
- FAC, 137
- mass, 138
- opacification, 69
- outflow tract, 138, 139
- volume, 137, 139, 140

license key, 152, 153

limits, 191

- operating, 191
- shipping, 191
- storage, 191

login, 41, 42

logs

- assert, 59
- DICOM, 59
- export, 60
- transducer, 59
- user, 59

lung

- exam type, 26
- intended use, 7

M

M Mode

- controls, 71
- definition, 68
- imaging or scanning, 71
- measurements, 97, 108

M-line, 71

maintenance, 154, 155

manual trace, 99

measurements

- 2D and Color, 94

- about, 92

- accuracy, 130

- area, 95

- calipers, 92

- cardiac, 108, 111

- circumference, 95

- delete, 93

- depth, 95

- distance, 94, 95, 97, 108

- Doppler, 97, 99, 100

- edit, 94

- follicle, 116

- gynecology, 115

- heart rate, 97, 98, 118

- obstetric, 118

- obstetrical, 119

- obstetrics, 117

- slope, 99

- time, 97, 98

- velocity, 98

mechanical index (MI), 196, 197

modes

- data, 54

- Doppler, 72

- imaging or scanning, 68, 192

monitor

- display, 54

- layout, 21

- touchscreen, 21

MPPS

- discontinue, 123

- servers, 45, 48

musculoskeletal (MSK)

- calculations, 120

- exam type, 26

- intended use, 8

N

needle

- guide, 84

- profiling, 82, 83

nerve

- exam type, 26

- intended use, 8

network

- directory server, 34

- ethernet, 44

- security, 260

- specifications, 256

- troubleshoot, 262

- wireless, 44

O

obstetrical

- exam type, 26

- intended use, 8, 9

- measurements, 117, 118, 119

- references, 144, 145, 147

- report, 127

- settings, 50, 51

- tables, 50

ophthalmic

- exam type, 26

- intended use, 8

orbital

- exam type, 26

- intended use, 7, 8

ovary, 115, 150

P

password

- change, 42

- requirements, 35

- user, 33

patient

- display, 54

- edit, 66

- enter, 21

- form, 61, 62, 65

- information, 61, 62, 63, 65

- list, 121

- new, 61, 65

- save, 66

pediatric

- intended use, 8

peripheral intravenous (PIV)

- exam type, 26

peripherals, 13, 182
pictographs, 88
ports, 12
power
 indicators, 17
 isolate from, 173
 settings, 55
 sleep, 55
 system, 15, 19

print
 images and clips, 89, 90
 troubleshoot, 152
probe (see [transducer](#))
procedure
 change, 65
 modify codes, 66
prostate
 exam type, 27
 intended use, 8, 9

Q

Qpath/Qview, 38, 126

R

references
 cardiac, 131
 general, 147
 obstetrical, 144, 145, 147
remove system, 14
reports
 about, 125
 delete calculations, 127
 display, 126, 127
 modify calculations, 126
 obstetrical, 127
 save, 127
review
 exam or study, 122
 images and clips, 127
 labels, 128
 patient information, 66

S

safety
 battery, 175
 clinical, 176
 electrical, 170, 173
 electromagnetic
 compatibility, 177, 180
 equipment, 174
 ergonomic, 168

save
 images and clips, 86, 87
 patient, 66
 report, 127
scanning
 2D, 69
 Color, 74
 controls, 68, 69, 73, 75
 Doppler, 72
 dual mode, 76
 M Mode, 71
 modes, 68, 192
 needle, 82, 83, 84, 85
 procedure mode, 70
 simultaneous or triplex, 76
search, 121
security
 precautions, 260
 standards, 194
select
 exam, 21, 26
 transducer, 21, 26
service, 155
settings
 abdominal, 51
 audio, 42
 clips, 86
 date and time, 54
 exam types, 51, 52
 import and export, 50, 57
 labels, 87
 obstetrical, 51
 power and battery, 55
 storage, 37
 USB, 58
shipping
 specifications, 191
 transducer, 166
Simpson's Rule, 109, 135, 139
simultaneous or triplex, 76
slope, 99
specifications
 environmental, 191
 network, 256
 system, 190
spine
 exam type, 26
 intended use, 8
stand
 clean and disinfect, 158,
 162

 remove system, 14
standards
 electromechanical, 193
 EMC classification, 193
 HIPAA, 194
startup screen, 21
steering
 Color, 75
 D-line, 72
 Doppler, 74
storage
 alerts, 37
 images and clips, 193
 internal, 37, 122, 124
 specifications, 191
 transducer, 165, 191
study (see [exam](#))
superficial
 exam type, 26
 intended use, 8
sweep speed
 Doppler, 74
 M Mode, 72
system
 clean and disinfect, 158,
 162
 controls, 68
 features, 12
 logs, 59
 transport, 15

T

technical support, 2
temperature limits, 191
text
 manual, 87
 move or edit, 87
 predefined, 87
thermal index (TI), 196, 197
time
 Doppler, 98
 M Mode, 97
time average mean (TAM),
97, 99, 149
time average peak (TAP), 97,
99, 149
time gain compensation
(TGC), 77
tissue harmonic imaging
(THI), 71
tissue models, 200

trace
 auto, 99, 100
 Doppler, 99
 manual, 99

transcranial
 exam type, 26
 intended use, 7

transducer
 clean and disinfect, 158
 definition, 265
 remove, 25
 select, 21, 26
 sheaths, 28
 ship, 166, 191
 storage, 165, 191
 transport, 166
 troubleshoot, 59, 152
 types, 265

transesophageal
 intended use, 9

transport
 system, 15
 transducer, 166

triplex, 76

troubleshoot, 2, 151
 network, 262

U

ultrasound terms, 254, 264

USB
 devices, 19
 export, 57, 58
 restrict, 36
 settings, 58
 troubleshoot, 152

user
 add new, 33
 change password, 42
 delete, 34
 login and logout, 41, 42
 logs, 59
 management, 33, 34
 password requirements, 35

uterus, 115, 150

V

vascular
 measurements, 114

vascular access
 exam type, 27

velocity
 maximum (VMax), 98, 99,
 148
 measurements, 98
 time integral (VTI), 98, 99,
 107, 149

venous
 exam type, 26
 intended use, 8

video
 clips, 86, 87, 127
 educational, 2, 21, 28
 help, 2, 21, 28

voice controls, 24, 79

volume
 atrial, 110, 135
 audio, 42
 bladder, 51, 150
 calculation, 96
 flow, 101, 150

LV, 109, 137
ovarian, 115, 150
reference, 149
stroke (SV), 109
uterine, 115, 150

W

warnings, definition, 1

wireless
 certificates, 40
 configuration, 46
 connect, 44
 network, 44
 transmission, 179

worklist
 access, 64
 barcode, 57, 63
 clear, 65
 configure, 48, 64
 patient information, 63, 65
 scheduled procedures, 65,
 66
 search, 65
 servers, 48

worksheets
 about, 125
 access, 38, 126
 custom, 38, 125, 126
 display, 125
 fill, 125
 import, 38
 remote, 38

Z

zoom, 78

FUJIFILM
SONOSITE

P31244-03

